

UNIVERSITY OF TORONTO

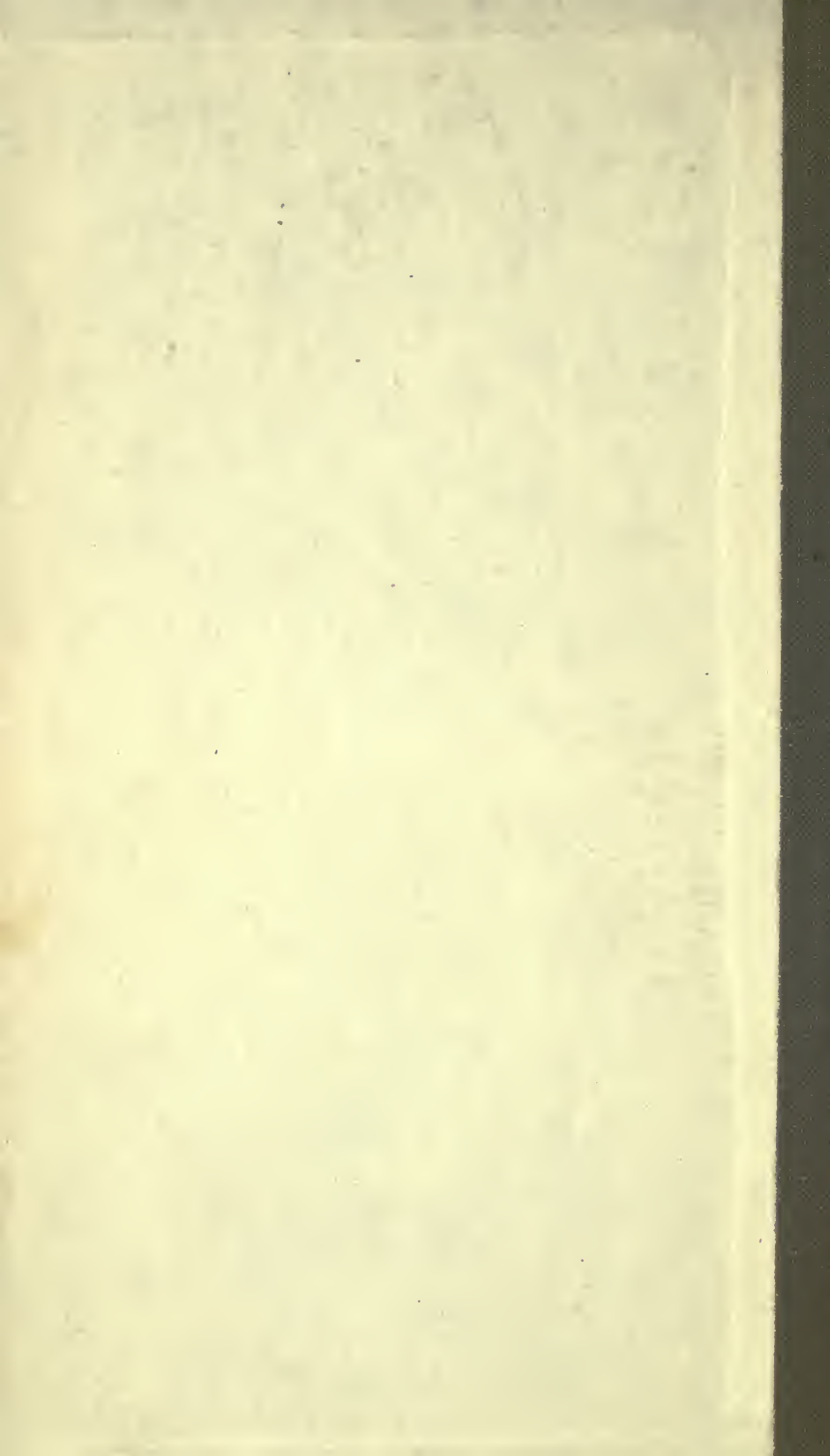

3 1761 01711304 4

UNIV. OF  
TORONTO  
LIBRARY







Digitized by the Internet Archive  
in 2007 with funding from  
Microsoft Corporation





THE DISSOCIATION OF  
A PERSONALITY

THE UNIVERSITY OF CHICAGO  
LIBRARY

THE UNIVERSITY OF CHICAGO  
LIBRARY



MIN  
P.

# THE DISSOCIATION OF A PERSONALITY

A BIOGRAPHICAL STUDY IN  
ABNORMAL PSYCHOLOGY

BY

MORTON PRINCE, M.D., LL.D.

PROFESSOR OF DISEASES OF THE NERVOUS SYSTEM  
TUFTS COLLEGE MEDICAL SCHOOL; PHYSICIAN  
FOR DISEASES OF THE NERVOUS SYSTEM  
BOSTON CITY HOSPITAL

SECOND EDITION

LONGMANS, GREEN, AND CO.

FOURTH AVENUE & 30TH STREET, NEW YORK  
LONDON, BOMBAY, AND CALCUTTA

1910

117494  
187111



*Copyright, 1905,*  
**BY LONGMANS, GREEN, & Co.**

*All rights reserved.*

First edition, December, 1905.  
Reprinted, November, 1906.  
Second edition, September, 1908.  
October, 1910.

**THE UNIVERSITY PRESS, CAMBRIDGE, U.S.A.**

## PREFACE

THE present volume contains Parts I and II of a larger work, "Problems in Abnormal Psychology," but it is complete in itself. It is a study of disintegrated personality, as exemplified by the very remarkable case of Miss Beauchamp. In this study I have (*a*) traced the development of the different personalities which originated through the disintegration of the normal self, and (*b*) shown their psychological relations to one another and to the normal self. By giving (*c*) a detailed account of the daily life of the personalities, after the manner of a biography, I have sought to show their behavior to the environment and the way in which a disintegrated personality can adapt itself to the circumstances of life, and how it fails to do so.

Selections from recorded observations, many times in number those here given, have been made use of with the view of familiarizing the reader with the main phenomena, so that when we come to consider in another volume the psychological problems involved, we shall have a knowledge of the fundamental data. These phenomena have been briefly discussed in this volume as an introduction to a deeper study.

By departing from the customary way of treating these phenomena and introducing them in the course of a

biography, I have been enabled to present them without removing them from their psychological setting. This method, too, has permitted not only greater latitude in their presentation, but, it seems to me, will tend to give a deeper meaning to the phenomena themselves and a better appreciation of those normal and abnormal alterations of the human mind which are met with in practical life.

While I have sought to interpret the various phenomena observed in ways which seem to me to be the logical inductions from the observations herein recorded, and from the established data of abnormal psychology, my first aim has been to secure the accuracy of the observations themselves.

A brief preliminary report of this case, under the title of "The Problem of Multiple Personality," was presented at the International Congress of Psychology, held in Paris, August, 1900.

In Part III, which will be issued as a separate volume, it is my present intention to discuss a series of problems which will include :

- (a) The theory of this case and of disintegrated personality in general ;
- (b) The Subconscious under normal and abnormal conditions ;
- (c) Hypnosis, Sleep, Dreams, and Somnambulism ;
- (d) Hysteria ;
- (e) Neurasthenic States ;
- (f) Alterations of Character ;
- (g) Hallucinations, Fixed Ideas, Aboulia, Amnesia, etc.

Abnormal psychology is fast forging to the front as an important field of research. The signs of the times point to this field, which has long awaited investigation by modern methods, as one to which scientific thought is now being directed and one which promises results of importance. Much work has already been accomplished, and a good beginning made. The ground, however, has only been opened, and rich rewards await the investigator. I trust that the present work will prove a contribution to our knowledge of the subject.

458 BEACON STREET, BOSTON,  
August, 1905.

## PREFACE TO THE SECOND EDITION

IN this edition some additional data which throw further light on the phenomenon of sudden conversion have been incorporated in an appendix (R). These data, which were obtained after the first edition went to press, complete those given in Chapter XXI. They were included in a paper entitled "The Psychology of Sudden Religious Conversion" published in the *Journal of Abnormal Psychology*, April, 1906. Besides this additional observation on the case which is the basis of this volume, a brief account is appended of another case of conversion (of a non-religious type) which I recently had an opportunity to submit to psycho-analysis almost immediately after the phenomenon occurred. A number of minor typographical and clerical errors in the text have been corrected since the first printing. The publication of Parts III and IV, which are now nearly completed, has been delayed, owing to the

large amount of new material which has been collected as the result of continued investigations. A new case of dissociated personality, fully as rich as the first in psychological phenomena, though not so dramatic in episodes, has been continuously studied for nearly two years and has furnished a considerable part of this material. The findings in this case confirm in every way those obtained in the Beauchamp case. The gain, through the use of this material, will prove, I believe, well worth the delay. I have also thought it wise to depart somewhat from the original plan of publication of succeeding parts. My present intention is to present in separate parts the study of each problem, one or more parts to a volume as may be most convenient. Part III will deal with the Co-conscious and Part IV with the Unconscious. These subjects should logically precede dissociated personality, hypnosis, and other allied states which cannot be comprehended without a knowledge of the co-conscious and the unconscious. I would add that the same is true of the principles of psychotherapy, which is so much in vogue at the present day. A stream of literature on psycho-therapy, or the mental treatment of nervous disorders, has during the last year or two come from the press, and there is at the present time a widely awakened public interest in this subject; but no treatment, whether psychic or physical, can be rational unless based on a sound knowledge of psycho-pathology. Any other basis of treatment must be empirical and therefore too often ineffective. As experimental research has shown that co-conscious and unconscious processes play a very extensive part in many functional nervous disorders, it is evident that a knowledge of these processes is absolutely essential for intelligent therapeutics.

AUGUST, 1908.

# CONTENTS

## PART I

### THE DEVELOPMENT OF THE PERSONALITIES

CHAPTER	PAGE
I. INTRODUCTORY . . . . .	1
II. MISS BEAUCHAMP . . . . .	9
III. THE BIRTH OF SALLY . . . . .	20
IV. THE BEGINNINGS OF AUTOMATISM . . . . .	52
V. INSTABILITY AND SUGGESTIBILITY . . . . .	64
VI. HOW SALLY GOT HER EYES OPEN AND THE SUBCONSCIOUS BECAME AN ALTERNATING PERSONALITY ; . . . . .	91
VII. SALLY "ON TOP OF THE HEAP" . . . . .	102
VIII. SUBCONSCIOUS BATTLES: ABOULIA, IMPULSIONS, OBSESSIONS . . . . .	119
IX. SALLY AS A SUBCONSCIOUS AND AS AN ALTER- NATING PERSONALITY . . . . .	144
X. SALLY TORMENTS MISS BEAUCHAMP WITH PRAC- TICAL JOKES . . . . .	156
XI. THE BIRTH OF B IV, "THE IDIOT" . . . . .	171
XII. A HOUSE DIVIDED AGAINST ITSELF . . . . .	187
XIII. THE BIRTH OF B I, "THE SAINT" . . . . .	210

## PART II

### THE HUNT FOR THE REAL MISS BEAUCHAMP

XIV. IS NOT B IV THE REAL MISS BEAUCHAMP? .	231
XV. DISSOCIATIONS OF CONSCIOUSNESS: AMNESIA .	251
XVI. AN IMPORTANT DISCOVERY: B I AND B IV WHEN HYPNOTIZED BECAME THE SAME PERSON .	266

CHAPTER	PAGE
XVII. STUDIES IN CHARACTER . . . . .	283
XVIII. IS B II THE REAL MISS BEAUCHAMP?—B I a	302
XIX. SALLY HYPNOTIZES B IV AND FIGHTS FOR CONTROL . . . . .	310
XX. DREAMS. B I AND B IV BECOME THE SAME PERSON WHEN ASLEEP . . . . .	326
XXI. THE PSYCHOLOGY OF SUDDEN CONVERSION: MISS BEAUCHAMP FALLS INTO A STATE OF ECSTASY AND BELIEVES HERSELF CURED .	344
XXII. SALLY PLAYS MEDIUM (SUBCONSCIOUS WRITING)	356
XXIII. THE AUTOBIOGRAPHY OF A SUBCONSCIOUS SELF	367
XXIV. HOW B I AND B IV WERE MADE ONE PERSON, AND THE UNEXPECTED CONSEQUENCES. . .	398
XXV. SOCIAL LIFE IN 1900 . . . . .	418
XXVI. SALLY SUCCEEDS IN BECOMING CONSCIOUS OF B IV'S THOUGHTS AND IS ASTOUNDED AT WHAT SHE LEARNS . . . . .	435
XXVII. B IV a . . . . .	444
XXVIII. EMOTION AND DISINTEGRATION . . . . .	456
XXIX. TYPES OF DISINTEGRATION: MENTAL STRAIN AS A CAUSE. . . . .	462
XXX. A CONTEST BETWEEN PERSONALITIES . . . . .	476
XXXI. A HALLUCINATION FROM THE SUBCONSCIOUS .	505
XXXII. THE REAL MISS BEAUCHAMP AT LAST, AND HOW SHE WAS FOUND . . . . .	514
APPENDICES . . . . .	527
INDEX . . . . .	571



71

PART I

THE DEVELOPMENT OF THE PERSONALITIES



# THE DISSOCIATION OF A PERSONALITY

## PART I

### THE DEVELOPMENT OF THE PERSONALITIES

#### CHAPTER I

##### INTRODUCTORY

MISS CHRISTINE L. BEAUCHAMP,<sup>1</sup> the subject of this study, is a person in whom several personalities have become developed; that is to say, she may change her personality from time to time, often from hour to hour, and with each change her character becomes transformed and her memories altered. In addition to the real, original or normal self, the self that was born and which she was intended by nature to be, she may be any one of three different persons. I say three different, because, although making use of the same body, each, nevertheless, has a distinctly different character; a difference manifested by different trains of thought, by different views, beliefs, ideals, and temperament, and by different acquisitions, tastes, habits, experiences, and memories. Each varies in these respects from the other two, and from the original Miss Beauchamp. Two of these personalities have no knowledge of each other or of the third, excepting such information as may be obtained by inference or second

<sup>1</sup> Pronounced *Beecham*. This name, which I have adopted for the purpose of disguising the identity of the subject, was originally taken in the spirit of fun by one only of the personalities to distinguish herself from the others. I have used the name for all three.

hand, so that in the memory of each of these two there are blanks which correspond to the times when the others are in the flesh. Of a sudden one or the other wakes up to find herself, she knows not where, and ignorant of what she has said or done a moment before. Only one of the three has knowledge of the lives of the others, and this one presents such a bizarre character, so far removed from the others in individuality, that the transformation from one of the other personalities to herself is one of the most striking and dramatic features of the case. The personalities come and go in kaleidoscopic succession, many changes often being made in the course of twenty-four hours. And so it happens that Miss Beauchamp, if I may use the name to designate several distinct people, at one moment says and does and plans and arranges something to which a short time before she most strongly objected, indulges tastes which a moment before would have been abhorrent to her ideals, and undoes or destroys what she had just laboriously planned and arranged.

Aside from the psychological interest of the phenomena, the social complications and embarrassments resulting from this inconvenient mode of living would furnish a multitude of plots for the dramatist or sensational novelist. Considered simply as a biography, therefore, an account of Miss Beauchamp's later life could scarcely fail to interest, if it were told divested of the details which are necessary for the purpose of scientific study.

Miss Beauchamp is an example in actual life of the imaginative creation of Stevenson, only, I am happy to say, the allegorical representation of the evil side of human nature finds no counterpart in her makeup. The splitting of personality is along intellectual and temperamental, not along ethical lines of cleavage. For although the characters of the personalities widely differ, the variations are along the lines of moods, temperament, and tastes. Each personality is incapable of doing evil to others.

Cases of this kind are commonly known as "double" or "multiple personality," according to the number of persons represented, but a more correct term is *disintegrated* personality, for each secondary personality is a part only of a normal whole self. No one secondary personality preserves the whole psychical life of the individual. The synthesis of the original consciousness known as the personal ego is broken up, so to speak, and shorn of some of its memories, perceptions, acquisitions, or modes of reaction to the environment. The conscious states that still persist, synthesized among themselves, form a new personality capable of independent activity. This second personality may *alternate* with the original undisintegrated personality from time to time. By a breaking up of the original personality at different moments along different lines of cleavage, there may be formed several different secondary personalities which may take turns with one another. Again, in the breakup certain conscious states, which are rejected in the synthesis of the new personality, may remain outside the consciousness of the latter, synthesized among themselves, and thus form a second *simultaneously* acting consciousness. This is called a subconsciousness. It will thus be seen that secondary personalities are formed by the disintegration of the original normal personalities. Disintegration as thus used must not be confused with the same term sometimes employed in the sense of degeneration, meaning a destroyed mind or organically diseased brain. Degeneration implies destruction of normal psychical processes, and may be equivalent to insanity; whereas the disintegration resulting in multiple personality is only a functional dissociation of that complex organization which constitutes a normal self. The elementary psychical processes, in themselves normal, are capable of being reassociated into a normal whole.

Quite a number of cases of disintegrated or multiple personality have been observed, sufficient to establish be-

yond all doubt the *bona fide* character of the phenomena, as well as the general principles underlying their development. The cases thus far studied and reported have represented varying degrees of complexity of organization of mental states and independence of the personalities. In the simpler forms the secondary personalities are manifested through highly synthesized "automatic" or hypnotic phenomena, and are recognized only as subconscious states through so-called automatic writing, and kindred manifestations, or else as states of hypnosis. The state called "Mamie," in the case of Mrs. R., reported by the writer,<sup>1</sup> and those of Léontine and Léonore in the case of Madame B., described by Dr. Pierre Janet, are examples of this simpler class.

In more fully developed forms the second personalities are identical with the trance states of mediums, like that of Miss "Smith," studied by M. Flournoy, and that of Mrs. "Smead," studied by Professor Hyslop. In such cases the second personality does not obtain a completely independent existence, but comes out of its shell, so to speak, only under special conditions when the subject goes into a "trance." The external life of personalities of this sort, so far as it is carried on independently of the principal consciousness, is extremely restricted, being confined to the experiences of the so-called "seance." Although such a personality is complete in having possession of the faculties of an ordinary human being, there is very little independence in the sense of a person who spontaneously and voluntarily moves about in a social world, and works, acts, and plays like any human being. It is questionable how far such a personality would be capable of carrying on all the functions of a social life, and of adapting itself to its environment. Hypnotic states, that is, artificially induced types of disintegration, are

<sup>1</sup> Boston Med. and Surgical Journal, May 15, 1890.

rarely, if ever, sufficiently complete, and possessed of adequate spontaneous adaptability to the environment to constitute veritable personalities.

In the most fully developed forms, in cases like that of Fèlida X., reported by M. Azam; of Louis Vivé, studied by several French observers; and of Ansel Bourne, studied by Dr. Richard Hodgson and Professor William James, the disintegrated personality retains that large degree of complexity of mental organization which permits complete, free, and spontaneous activity, approximating, at least, that of normal mental life. Though some cases exhibit glaring mental and physical defects, others may, to the ordinary observer, exhibit nothing more than an alteration of character and loss of memory for certain periods of life. Such persons often pass before the world as mentally healthy persons, though physically they may be neurasthenic. But a careful psychological examination will reveal deviations from the normal which show the true character of the alteration. It is to this last category that Miss Beauchamp belongs. In any one of her mental states she is capable of living her social life and doing her daily duties, subject only to the limitation set by poor general health; and, as a matter of fact, each personality leads its own life like any other mortal.

In some cases there is no loss of memory, and then it may be difficult to recognize that we have to do with a true disintegrated personality, and not with only a neurasthenic or hysterical condition. Such cases are generally overlooked. One of the personalities in this case was of this type.

The mode of development of phenomena of this sort, the relation of the personalities to one another, and the behaviour of the disintegrated minds to artificial excitations and the environment are fascinating objects of study, not only for the phenomena themselves, but for the light which they throw upon the functioning of the human mind.

Miss Beauchamp has been under observation of one kind or another for many years, enabling her friends and those particularly interested in her to know her well. She has been under the writer's professional care for more than seven years, that is, since the early part of 1898. During most of this time she has been under constant and often for long periods daily observation.

For a satisfactory comprehension of the mental phenomena which are the object of this study, as well as of the causes, physical and psychical, which led to their development, it is desirable that the reader should have some knowledge of the character of Miss Beauchamp, and of her heredity and early life.

It will be understood that the writer feels some delicacy in giving publicity to the private life — even though the identity be concealed — of a sensitive, refined person, who, by natural instinct, shrinks from any discussion of herself; and, though her free permission has been given for study and publication, I shall limit all account of her personal and family characteristics to the narrowest limits that are compatible with the requirements of the case.

When speaking of the characteristics of "Miss Beauchamp," or when I say "she" or "her," it may pertinently be asked, "Which Miss Beauchamp?" or "Which she?" It will facilitate a comprehension of the important features of the case, and a better appreciation of the various situations, as they unfolded themselves in this psychological drama, if for the present the name Miss Beauchamp is limited to the person with whom I first became acquainted and who was known to her intimate friends, schoolmates, and teachers. Whether or not this Miss Beauchamp was the Real Miss Beauchamp was a question which there was no reason at that time to raise, and whether she was or not I shall let the history of this case disclose. My first ac-



quaintance was entirely professional, and there was no ground to suspect that any other personality existed.

The Miss Beauchamp whom I first knew was the only one known to a small but appreciative circle of friends, whose solicitude she had awakened. She was in college at the time, highly regarded by her teachers and classmates, and recognized as a diligent and conscientious student. Whatever the future was to reveal, it was this person alone who for years had been known as Miss Beauchamp, and who had been educated, cared for and esteemed as Miss Beauchamp. Let it be understood, then, that in describing Miss Beauchamp, or whenever referring to her, the name, unless otherwise qualified, refers to the first Miss Beauchamp, the one who first came under observation. At a later period, for the sake of brevity, and for the purpose of distinguishing her from the others, she was also named B I. The other personalities and hypnotic selves were designated B II, B III, B IV, etc., as they appeared. These somewhat clumsy terms were employed to avoid committal to any hypothesis until the phenomena had been thoroughly studied.

It is important to bear in mind the fact that Miss Beauchamp was well known, even if her circle was a small one, and that when she came under observation she had established during the course of a number of years strong bonds of association with her friends. If it turned out that our protégé was not after all the *real person* who had been born into this world, it still should be kept in mind that no reason appeared until a comparatively recent period, to suspect the possible previous existence of any other personality.

During the past six years<sup>1</sup> (1898-1904) the three personalities have been playing a comedy of errors, which has been sometimes farcical and sometimes tragic. They run

<sup>1</sup> Written in 1904.

on and off the stage in a way confusing to the observer, changing places from moment to moment, each personating the others in scenes to which she was but a moment before a stranger, and with the exception of Sally, having no knowledge of what has gone before. During these years the writer has kept copious notes, often made daily, of the life of Miss Beauchamp. The evidence given by all three personalities, as well as by the hypnotic selves, has been laboriously recorded. Every piece of evidence which would throw light upon, substantiate, or discredit any alleged occurrence or mental phenomenon has been made use of. At all times, including intervals of enforced absence, as in the summer vacations, a considerable correspondence with each personality has been kept up. Much of this has been made use of in the following account.

## CHAPTER II

### MISS BEAUCHAMP

MISS BEAUCHAMP—I mean the one who first presented herself for professional care in the spring of 1898 (B I)—is extremely reticent and dislikes intensely any discussion of herself or her circumstances. She is even reticent in reference to her physical ailments, so much so that it is never easy to discover any temporary indisposition from which she may be suffering. She dislikes the publicity which her psychical trouble tends to draw upon her, and has sought jealously to guard her secret. Indeed, all three personalities have endeavored by every artifice to conceal the knowledge of their trouble from friends, and have done so with a success that is astonishing. It has been at the expense of being considered a strange, incomprehensible person, “unlike other people,” as may well be the case when three persons have to act one rôle in life’s comedy. The publication of this study has been consented to by Miss Beauchamp, as a personal favor, at the sacrifice of all her instinctive tastes and inclinations. The constant answer to my frequent remonstrance about her reticence is, “I have never been in the habit of talking about my private affairs.” All this is carried to the verge of morbidness, or to what more exactly might be termed “*fixed ideas*.” I mention this merely as evidence of the absence of any desire for notoriety, or exaggeration. Nevertheless, I am acquainted with all the important details of her past and present life.

Besides the reticence in matters pertaining to herself, already mentioned, she is possessed of a conscientiousness

which at times has proved embarrassing to her friends. It, too, is carried sometimes to a degree that may be characterized as morbid. For instance, while in college she was the recipient of a scholarship; consequently she considered it her duty, in return for this benefit, so diligently to apply herself to her studies that it was impossible for teacher or physician to enforce sufficient recreation, or even the rest and hygienic measures which were absolutely necessary to keep what little health she had.

Equally embarrassing from a therapeutic point of view is a morbid pride which makes her unwilling to be the recipient of favors or attention which she may not be able to repay. The other selves are not always so sensitive in this respect, and bitterly has Miss Beauchamp sometimes suffered when she has come to herself to find that she has, as one of her other selves, accepted obligations distasteful to her own pride.

A love of truth which is equally marked in her make-up, and which has been in constant conflict with the endeavor to conceal her mental troubles, has led to much mental perturbation. To be frank and open, and yet not to "give away" the fact that she has not the remotest idea, at moments when she comes to herself, of how she happens to be in a given situation, or what her interrogator is talking about, or even who he is, taxes her innate sense of truth, though it has developed a capacity for intellectual gymnastics and quick inference which is instructive. Her power in any one of the three characters of taking in a new situation, of jumping at correct inferences of what has gone before, of following leads without betraying her own ignorance, of formulating a reply which allows of an interpretation compatible with almost any set of conditions, — her ingenuity in these directions is surprising; and by showing what can be done by shrewd leads, guesses and deftly worded responses, gives one an inkling as to

the possible origin of much of the supposed supernormal knowledge of mediums. In the case of Miss Beauchamp this is, of course, compulsory from the necessity of adapting her divided personality to the demands of social life.

If Miss Beauchamp's eye should peruse this paper, perhaps she will overlook the personality of the statement that her refinement of character is out of the ordinary. I do not mean by this only the kind of refinement which comes from social education, but rather, that natural refinement of thought and feeling which is inborn, and which is largely made up of delicacy of sentiment and appreciation of everything that is fine in thought and perceptions. This refinement is not easy to analyze, though readily recognized, and would not be mentioned here, were it not the basis of other peculiarities of her character which are of practical moment. It is largely the sponsor for her conscientiousness and honesty, her power of attracting friends, and, unfortunately, probably in part for her neurasthenic condition. It has also been the cause of no end of trouble in the prosecution of this study, for it has led to her unwillingness to "inflict," as she calls it, her personal affairs on others, and to her reticence about her mental life. One could often wish she were less sensitive, and had a little of that mental and moral callousness which does not shrink from opening the mind to psychological analysis.

In ending this brief account of Miss Beauchamp's character, I would add, she is well educated and has marked literary tastes and faculties. She is essentially a bibliophile, and is never so happy as when allowed to delve amongst books, to live with them and know them.

The little that is known of her heredity from a neuro-pathic point of view is suggestive of nervous instability. Her grandfather on her father's side is said to have been a

man of violent temper, and it would seem without balanced self-control. Her father apparently inherited the violent temper of her grandfather. He and her mother were unhappily married.

The subject of this study was a nervous, impressionable child, given to day-dreaming and living in her imagination. Her mother exhibited a great dislike to her, and for no reason, apparently, excepting that the child resembled her father in looks. The general impression left on Miss Beauchamp's mind to-day is that of her presence having been ignored by her mother excepting on occasions of a reprimand. On the other hand, she herself idealized her mother, bestowing upon her almost morbid affection; and believing that the fault was her own, and that her mother's lack of affection was due to her own imperfections, she gave herself up to introspection, and concluded that if she could only purify herself and make herself worthy, her mother's affection would be given her. The effect of all this upon the child was to suppress all disclosures of her own mental life, and to make her morbidly reticent. She never gave expression to the ordinary feelings of everyday child life; never spoke to say that she was tired, hungry, or sleepy. She lived within herself and dreamed.

When she was thirteen her mother died. This was a great shock to her mental system, and for a number of weeks she was probably half delirious, or, as we would now interpret it, disintegrated. The three years following her mother's death, when she lived with her father, were a period of successive mental shocks, nervous strains and frights. The details of this unhappy period, although of great importance from a psychopathic point of view, unfortunately cannot be given, as, being well known to neighbors and friends, they would lead to the identification of the subject. It is unlikely that even a strong constitution would withstand the continuous nervous

strain and depressing emotional influences to which her whole childhood was subjected. At sixteen she ran away from home, and thus ended this hystero-genetic period. At a later period anxieties of another kind succeeded those of her youth.

In Miss Beauchamp's heredity and childhood, then, we find ample to account for the psychopathic soil which has permitted her present condition. She was never strong, as a child, became easily tired, and suffered from headaches and nightmares. Attacks of somnambulism also occurred. On one occasion when about fourteen years of age she walked out into the street at night in her nightgown and was brought home by a policeman. For years she was in the habit, from time to time, of going into spontaneous trance-like states, lasting a few minutes, and at the time when she first came under observation she was subject to these spells (as was subsequently learned), although they were not nearly so frequent or prolonged as formerly. For instance, one day, an attack came on while she was crossing the Public Garden. At the moment she was headed for Park Square. When she came to herself she was walking in an opposite direction, in a different part of the Garden.

As a child, then, the subject of our study was morbidly impressionable, given to day-dreaming and unduly under the influence of her emotions. She took everything intensely, lived in a land of idealism, and saw the people and the world about her not as they were but as they were colored by her imagination. That is to say, she saw people through her own ideas, which dominated her judgment, and which tended to be insistent. Even as a child she appeared to have hallucinations, or at any rate so mixed up her day-dreams and imaginings with reality that she did not have a true conception of her environment.

Such a person, under the unhappy circumstances of her

girlhood, surely never had half a chance. Her very differences from the conventional person stamped her an "original," and attracted other people to her. Intellectually she was keen, fond of books and study. The knowledge that she thus acquired being colored by the wealth of her imagination gave an attraction to her personality.

About 1893 she had a nervous shock which, unfortunately, only came to my knowledge long after I became acquainted with the fact of there being a division of personalities; unfortunately, for it played the principal rôle in the development of these phenomena. It will be described in its proper place.

When Miss Beauchamp first came under my professional care, in 1898, she was, as has been said, a student in one of our New England colleges; she was twenty-three years of age and a "neurasthenic" of an extreme type. The most salient features of her physical condition were headaches, insomnia, bodily pains, persistent fatigue, and poor nutrition. All this unfitted her for any work, mental or physical, and even for the amount of exercise that ordinary rules of hygiene required; but in spite of her disability nothing could dissuade her from diligent and, in fact, excessive study which she thought it her duty to persist in. My notes taken at this time, before it was known that there was any division of personalities, thus describe her general condition:

"Is a pronounced neurasthenic of extreme type; has never been able to pursue steadily any occupation in consequence. Tried three times to do professional nursing and broke down. Is now studying at — College; ambitious; good student; does good work, but always ill; always suffering. Over-conscientious and mentally and morally stubborn. Is very nervous, and different parts of body in constant motion. General appearance of an hysteric; cannot sit still, cannot fix her eyes to properly test field of vision; probably slight visual limita-



tion, but this is difficult to determine. *No objective anesthesia, or other physical stigmata.*"

At this time Miss Beauchamp was very suggestible and plainly manifested aboulia, although this was mistaken by her friends and at first by myself, to speak plainly, for stubbornness (which was one of her traits), or at least an unwillingness to be guided by the advice of friends when this conflicted with her prejudices. By *aboulia* is meant an inhibition of will by which a person is unable to do what he actually wishes to do.<sup>1</sup> There was also a decided limitation of the field of consciousness, in the sense that her mind at certain-moments was strongly absorbed in and dominated by certain particular ideas. She was unable to correct her judgments by constant reference to and comparison with collateral facts, which is always necessary for wise conduct. In other words, she tended to be lost in abstraction. These are recognized psychological stigmata of hysteria.

It was said in the beginning that, in addition to her normal self, and the hypnotic state known as B II, Miss Beauchamp may be any one of three different persons, who are known respectively as B I, B III, and B IV. These numbers were originally given at an early period of the study, before the mental states were identified, and when it was desirable that terms should be used which were not a committal to any hypothesis. The numbers were affixed to the personalities as they were chronologically discovered. That is to say, when Miss Beauchamp first came under observation she was known of course by her own

<sup>1</sup> In typical and extreme cases, for instance, a person with aboulia may find it impossible to pick up something from the table, or to rise from the chair, though strongly desiring to do so. In Miss Beauchamp's case I have often known her to come to my office for the express purpose of telling something important, but after struggling a few minutes with attempts to speak, to utter the words necessary, and finding herself unable, she would give it up and leave without accomplishing or even explaining her errand.

name. Later, when she was hypnotized, her mental state in hypnosis was known as the hypnotic self. Everything was then simple enough, for we had to do only with a person awake and hypnotized, and no extended nomenclature was required. Later, when another mental state was discovered, it became necessary to have distinguishing terms; so Miss Beauchamp was called B I, the hypnotic state B II, and the third state (at first thought to be a second hypnotic state, but later proved to be a personality) was named B III. Still later, a fourth state developed and was termed B IV.

B I was known as Miss Beauchamp.

B III was known as "Chris," in distinction from "Christine," the Christian name of Miss Beauchamp. Later, Chris took the name of Sally.

B IV had no other name, although Sally dubbed her "the Idiot."

Now these three personalities had very sharply defined traits which gave a very distinctive individuality to each. One might say that each represented certain characteristic elements of human nature, and that the three might serve as an allegorical picture of the tendencies of man. If this were not a serious psychological study, I might feel tempted to entitle this volume "The Saint, The Woman, and The Devil." The Saint, the typical saint of literature, is B I. Her character may fairly be said without exaggeration to personify those traits which expounders of various religions, whether Christian, Buddhist, Shinto, or Confucian, have held up as the ideals to be attained by human nature. To her mind selfishness, impatience, rudeness, uncharitableness, a failure to tell the truth or a suppression of half the truth were literally sins, and their manifestation wickedness, to be cast out by fasting, vigils, and prayer. She frequently makes allusion to such sins in her letters. B IV is the Woman, personifying the

frailties of temper, self-concentration, ambition, and self-interest, which ordinarily are the dominating factors of the average human being. Her idea in life is to accomplish her own ends, regardless of the consequences to others, and of the means employed. Sally is the Devil, not an immoral devil, to be sure, but rather a mischievous imp, one of that kind which we might imagine would take pleasure in thwarting the aspirations of humanity. To her pranks were largely due the moral suffering which B I endured, the social difficulties which befell B IV, and the trials and tribulations which were the lot of both.

Not the least interesting of the curious nervous phenomena manifested, are the different degrees of health enjoyed by the different personalities. One would imagine that if ill health were always based on physical alterations, each personality must have the same ailments; but such is not the case. The person known as B I, has the poorest health; B IV is more robust, and is capable of mental and physical exertion without ill effects, which would be beyond the powers of B I; while B III is a stranger to a ache or pain. She does not know what illness means.

This personality, Sally, like the others, at times is an alternating personality. But, besides this, at other times it is a group of dissociated conscious states, which, existing simultaneously with the primary self, whether B I or B IV, is technically termed a subconsciousness,— a subconscious personality. This subconscious personality and the waking personality together represent a doubling of the mind. But this doubling exists because certain mental states have been dissociated from the main stream of consciousness and have acquired a more or less independent existence, and formed an *extra* mind. As a result of long years of experience, the acquisition of long chains of memories, this second stream has acquired a wide field of

mental life. Nothing of this life is known to the main personal stream of consciousness.

The theory of a subconscious self will be discussed in another volume, and it would be premature to enter into the question here. I merely wish to point out in a general way that by a subconscious self I mean simply a limited second, coexisting, extra series of "thoughts," feelings, sensations, etc., which are (largely) differentiated from those of the normal waking mind of the individual. In abnormal conditions these secondary "thoughts" may be sufficiently organized to have a perception of personality, in which case they may be regarded as constituting a second self. Such a second self is not known to the waking self, which is not even conscious of its existence (excepting of course by inference from acts). B III was such a subconscious self. Whether such a self, or any of the elemental states which comprise such a self belongs to normal minds, or occurs only under abnormal conditions, is a secondary question that will be discussed in its proper place. But the question of what part subconscious states play in normal minds is one of the most pressing problems of psychology. However that may be answered, repeated observations of recent years by different students of these phenomena have shown that in unstable natures the mind may be disintegrated in such a way as to produce a doubling or rather a multiplication of consciousness and to form two, three, or more groups of subconscious states, which at times are capable of considerable independent activity. At times when excited they are capable of being stirred into fury, when they burst forth like a volcano, fermenting and boiling, in "crises" of a pathological character. Such were the so-called "demoniac possessions" of the middle ages, and such are the hysterical crises of modern medicine. [Appendix A.]

In this account I shall describe with great detail the

genesis of the different personalities and the conditions under which they originated, in order that the entire freedom from educational and artificial influences, such as might be suspected to have shaped their characters and memories, may be evident and put beyond question.

## CHAPTER III

### THE BIRTH OF SALLY

**I**N April, 1898, inasmuch as Miss Beauchamp had failed to be improved by the conventional methods of treatment, and as it was impossible for her to pursue any vocation in the condition of health in which she was at the time, it was decided to try hypnotic suggestion. I have no intention of going into this aspect of the case, but I transcribe a few of the notes made at the time, as they show the extreme suggestibility of the subject, and make clear the beneficial effects which were obtained by this mode of treatment. By suggestion it was found possible to convert a condition of constant physical distress into one of at least temporary comfort. If this means proved ineffectual to remove the existing instability of the nervous system, which constantly allowed painful reactions to the environment, it was partly because of a primary faulty organization, but more particularly because of the condition of psychological disintegration which had already taken place, but which was unsuspected. There was no reason to suppose that the first Miss Beauchamp was psychologically other than she appeared to be, a whole person, so to speak. It was only after a prolonged study, which justified itself scientifically, that the secret leaked out. It then became clear that a permanent cure could come about only as a result of a synthesis of the disintegrated elements of personality. Yet it was something to banish pain whenever it arose.

Miss Beauchamp was hypnotized for the first time April 5th. She went at once into deep hypnosis, followed by

amnesia (total loss of memory) for the period when she was in hypnosis. This was repeated on the 6th, 7th, and 8th, appropriate suggestions being given each time, and was always followed by immediate relief. From notebook :

*April 8th.* "Reports slept soundly all night without waking; ravenously hungry at meals; has felt well; little or no fatigue; pain returned in the side, *while in church*, and lasted for an hour; it was very severe, but suddenly ceased; no pain in the morning on awaking, but has now some headache and backache. Her friends comment on her great improvement in health, and she herself is astonished. In hypnosis patient said that pain in side was caused by sermon, which made her think how wicked she was (etc.). No pain from walking."

*April 9th.* "Reports herself remarkably well; has walked about all day — out and about since 9 A. M.; no pain in side, no headache or backache; slept well; quiet; thinks she is not nervous; feels like a different person; remarks that she 'can't understand it,' etc., etc.; eats well. Patient appears like a different person: that is, is much better."

*April 25th.* "General improvement since April 9th. Is becoming stronger; occasional pain in side, but not nearly so severe, occasionally brought on by walking, sometimes by being bothered; feels stronger and better than for years; has been walking about two miles a day, formerly not more than two or three blocks; can walk a mile at a stretch without feeling more than reasonably tired; no headache to speak of up to yesterday."

It has always been easy to remove from time to time the varying bodily discomforts as they appeared, although this improvement was not lasting. These somatic symptoms have a psychological interest in this case, for it has been easy to demonstrate that they are not based on underlying structural changes, but are by-products, so to speak, of emotional states, or fatigue, and in part "association phe-

nomena," which are dragged into the field of consciousness by the psychical states to which they are attached.

Particular emotional states, like fear or anxiety, or general mental distress, have the tendency to disintegrate the mental organization in such a way that the normal associations become severed or loosened. Thus it happens that a mental shock like that of an accident, or an alarming piece of news, produces a dissociation of the mind, known as a state of hysteria or "traumatic neurosis." Such states are characterized by persisting loss of sensation, paralysis, amnesia, and other so-called stigmata, which are now recognized to be manifestations of the dissociation of sensory, motor, and other images from the main stream of consciousness. A doubling of consciousness is thus brought about. The dissociated images may still be capable of functioning, more or less independently of the waking consciousness; and when they do, so-called automatic phenomena (hallucinations, tics, spasms, contractures, etc.) result. Sometimes the mental dissociation produces a complete loss of memory (amnesia) for long periods of the subject's life; when this is the case we have the fundamental basis for alternating personalities, of which this study will offer many examples. In other instances, the disintegration induced by the emotion results less in sharply defined somatic disturbances than in a general loosening of the mental and nervous organization. A general neurasthenic condition then results, revealed by all sorts of perverted reactions to the environment in the form of pains, fatigue, vasomotor disturbances, etc. Finally, when the neurasthenic systems have been repeatedly awakened by an emotion, they form a habit, or what I have termed an "association neurosis."<sup>1</sup> It then comes about that (in subjects of nervous instability) when, through the vicissitudes of life, distressing emotions are

<sup>1</sup> Association Neuroses; Journ. of Nervous and Mental Disease, May, 1891.



awakened, the somatic symptoms, as a kind of tail to a mental kite, are brought into the field of consciousness. Fatigue and mental strain have the same genetic influence as emotion.

The whole history of the Beauchamp "family" has been like that of a person who has been exposed to an almost daily series of railroad accidents or nervous shocks. Owing primarily to a natural, and secondarily to a still greater acquired, instability of nervous organization, the contretemps of ordinary life have acted like a series of mild shocks, resulting in little traumatic neuroses.<sup>1</sup> The immediate effects have been removed from time to time by suggestion; but the original fundamental instability, magnified a hundred-fold by the psychological disintegration which was brought about by a mental accident of recent date, has made possible a frequent repetition of such shocks. Most instructive is the fact that with the complete synthesis of all the personalities into one, with the reintegration of the shattered mental organization, stability becomes re-established and the physical health becomes normal. With this statement the therapeutic aspect of the case will be dismissed for the present from further discussion.<sup>2</sup>

Miss Beauchamp has already been described as a very reserved person. She never drops into familiarity of speech, nor does she invite it. Her personality is one that cannot be provoked into rudeness; rather her tendency is to bear in silence what others might resent. If any one has done ill to her she bears it in resignation, without idea of retaliation by word or deed. Personal dignity, a predominant characteristic, never lets her descend into the vulgarisms which ordinary, though refined, people may be pardoned for falling into under the stress of petty annoy-

<sup>1</sup> Disturbances of the nervous system caused by accidents.

<sup>2</sup> In Part III, Vol. II, the neurasthenic state, including the relation of changes in physical health to psychic states will be considered.

ances. This I mention here, that the differing characteristics of the separate personalities, as the latter are developed, may be appreciated. With me and with those who know her trouble, she has a depressed, rather weary, expression and manner. Her voice, too, is strongly indicative of this frame of mind; but I am told that with strangers who know nothing of her infirmity she is more buoyant and light-hearted.

It is not easy to describe satisfactorily this Miss Beauchamp in hypnosis; at least in such a way as to give one who is not familiar with hypnosis an intelligible understanding of her in this state. In essential characteristics she <sup>1</sup> is not very different from herself awake, except as any one in hypnosis differs from the waking self. If I said that she is herself intensified, but without the artificial reserve with which she ordinarily surrounds herself as a protection to her life, it would give the best idea of her. In manner, her air of sadness and weariness is accentuated, and her tastes and desires are the same; but she does not hesitate to give freely information which it is essential for her well-being should be known, and to ask for aid that will protect her even from herself. In the waking state, as Miss Beauchamp, she desires to give the same information and she often longs to make the same request, but is as often held back by that intense shrinking from talking about herself which has already been mentioned. So prohibitive has been this reserve that it has been difficult to obtain from her while awake, as B I, a reasonable amount of information regarding her infirmity. This amounts at times to an actual aboulia. I doubt if the hypnotic self could be made to do what she in her waking state would morally object to. Perhaps it is not too far-fetched to say, metaphorically, that the hypnotic self is the soul of Miss

<sup>1</sup> This state, being B I hypnotized, was later rechristened B Ia, and the term B II was given to another state with quite different characteristics.

Beauchamp freed from the artificial restraints of conventionality.

The hypnotic self, then, let it be borne in mind, is distinctly the same personality as Miss Beauchamp awake. She speaks of herself as the same person, making no distinction whatsoever, except that she is now "asleep," or what "you call asleep." On the other hand, when awake, as already stated in the introduction, she has no knowledge or remembrance of herself in the hypnotic state. On awaking there is complete oblivion of everything said and done in hypnosis. There is also a large degree of passiveness in the hypnotic self. She sits with her eyes closed (never having been allowed to open them), and though she converses, and even sometimes argues and defends her own views, she tends to passiveness, like most subjects in hypnosis.

Up to this time the only personality with which I was acquainted, and the only one known to her friends, was the Miss Beauchamp whom I have just described as B I. But there now appeared upon the scene a new character, who was destined to play the leading rôle in the family drama that was enacted during a period of six years. This character at first appeared to be a second hypnotic state, but later proved a veritable personality, with an individuality that was fascinatingly interesting to watch; she largely determined the dramatic situations, and consequently the health, happiness, and fortunes of Miss Beauchamp. She became known successively as B III, Chris, and finally as Sally, according as acquaintance with her grew. The way this character first made herself known I shall let a résumé of my notes, which were made at the time, tell.

One day in April, 1898, while in hypnosis, Miss Beauchamp surprised me by denying having made certain statements which she made during the previous state of hypnosis, and then again later when hypnotized, admitting

freely, without reserve, what she had previously denied. She thus alternately denied and admitted the same facts. The statements themselves were not matters of importance, but the denials of her own plain statements were puzzling. Being on my guard, my first suspicion of course was of an attempt at deception, but on a repetition of this experience her honesty became plainly beyond question. The solution was not long in coming. On one of the following occasions I was startled to hear her, when hypnotized, speak of herself in her waking state as "She." Previously, as already stated, she had always used the first person, "I," indifferently for herself, whether awake or asleep in hypnosis. She had never made any distinction whatever as to personalities, or suggested any difference between herself while awake and while in hypnosis; nor had I made any such suggestions, or even thought of the matter. I had regarded the hypnotic self simply as Miss Beauchamp asleep. But now the hypnotic self, for the first time, used the pronoun "She," in speaking of her waking self, as if of a third person; but used "I," of herself in hypnosis. The tone, address, and manner were also very different from what they had been. As bearing on the question of the possible unconscious education of the subject on the part of the experimenter, I may say here that my experience of this case entirely contradicted the view that I had held up to this time. My conviction had been growing that so-called personalities, *when developed through hypnotism*, as distinct from the spontaneous variety, were purely artificial creations, — sort of unspoken and unconscious mutual understandings between the experimenter and the subject, by which the subject accepted certain ideas unwittingly suggested by the experimenter. But in opposition to this view the personality known as B III, or Chris, which first made its appearance during hypnosis, came as a surprise to me; and so far from being the

product of suggestion, originated and persisted against my protests and in spite of my scepticism. In view, therefore, of my own lack of preparedness, this complete change of attitude of the hypnotic self is noteworthy. I hastened to follow up the lead offered and asked, as if in ignorance of her meaning, who "She" was. The hypnotic self was unable to give a satisfactory reply.

"You are 'She,' " I said.

"No, I am not."

"I say you are."

Again a denial.

Feeling at the time that this distinction was artificial, and that the hypnotic self was making it for a purpose, I made up my mind that such an artifact should not be allowed to develop. I pursued her relentlessly in my numerous examinations, treated the idea as nonsense, and refused to accept it, but with what success will be noted.

Finally:

"Why are you not 'She'?"

"Because 'She' does not know the same things that I do."

"But you both have the same arms and legs, have n't you?"

"Yes, but arms and legs do not make us the same."

"Well, if you are different persons, what are your names?"

Here she was puzzled, for she evidently saw that, according to her notion, if the hypnotic self that was talking with me was Miss Beauchamp, the waking self was not Miss Beauchamp, and *vice versa*. She appeared to be between the horns of a dilemma, was evasive, unable to answer, and made every effort not to commit herself. On another occasion, in answer to the question why she (the *apparently* hypnotic state) insisted that Miss Beauchamp in her waking state was a different person from herself at that mo-

ment, the contemptuous reply was: "Because she is stupid; she goes round mooning, half asleep, with her head buried in a book; she does not know half the time what she is about. She does not know how to take care of herself." The contemptuous tone in which she spoke of Miss Beauchamp (awake) was striking, and her whole manner was very different from what it formerly had been when hypnotized. The weary, resigned, attitude was gone; she was bold, self-assertive, unwilling to accept suggestions, and anything but passive. A few days after this, when hypnotized, all became changed again; the former hypnotic manner returned.

"Who are you?" I asked.

"I am Miss Beauchamp."

Then, after a number of questions on another point:

"Listen: now you say you are Miss Beauchamp."

"Yes."

"Then why did you say you were not Miss Beauchamp?"

[Surprised.] "Why, I never said so."

"The last time we talked you said you were not Miss Beauchamp."

"You are mistaken. I did not. I said nothing of the sort."

"Yes, you did."

"No."

. . . . .

"Well, you know who you are?"

"Yes, Miss Beauchamp."

"Exactly. You have got over that idea of being different from other persons, — that there is a 'She'?"

[Surprised and puzzled.] "What 'she'? I do not know what you mean."

"Yes, you do."

"No, unless you mean Rider Haggard's 'She.'"

"You used to tell me that you were not Miss Beauchamp."

“I did not.”

“That when you were awake you were a different person.”

[Remonstrating and astounded.] “Dr. Prince, I did not say so.”

“What did you say?”

“I did not say anything. I told you about my back and shoulders.” [Referring to an experiment tried to produce a blister by a suggestion given to the hypnotic self.]

Repeated experiences of this kind made it plain that Miss Beauchamp when hypnotized fell into one or the other of two distinct mental states, or selves, whose relations to the primary waking consciousness, as well as their memories, were strikingly different. From the very first they claimed different relations with the waking Miss Beauchamp. The first hypnotic self either definitely stated she was Miss Beauchamp asleep, or accepted that idea, as a technical expression, without objection; though she apparently recognized the paradox conveyed in the idea of a sleeping person talking. Still she regarded herself most distinctly as Miss Beauchamp, though not awake. For the sake of convenience at this early stage, to distinguish the different selves, this hypnotic self was noted as B II, in distinction from the waking Miss Beauchamp, who was now labelled for the first time B I. In contrast with this attitude of B II, the second hypnotic self, who was correspondingly named B III, refused from the very first to accept the idea of being asleep or being Miss Beauchamp asleep. She insisted she was wide awake, and resented in a way foreign to either B I or B II every attempt on my part to make her appear illogical in claiming to be a different person.

It may be well to repeat that B I's name was Christine. Desiring to have some distinctive term of address for B III, I gave her the name of *Chris*. Later, of her own

volition, she adopted the name *Sally Beauchamp*, taking it, I think, from a character in some book.

The following notes of the interview of April 30 make evident the distinction between the hypnotic states :

*April 30.* "Patient has not been here since April 25th, when Miss Beauchamp had apparently lost her second personality; that is to say, she did not know in hypnosis who 'She' was, and denied all knowledge as claimed by B III of any other person than herself, and had no recollection of her previous statement as B III. It appeared as if the second phase of hypnosis had disappeared. To-day patient returned, stating that she has been unable to come before because of illness; has had a return of old symptoms, etc. *Remarks that she has been unable to read or fix her mind on a book.* To-day is much better. Thinks the cause of her relapse was catching cold, and possibly the effect of the sermon the previous Sunday. [This sermon had been the subject of considerable discussion between B II and myself at the previous visit.] Miss Beauchamp is now hypnotized and becomes, as at the last sitting, B II, the first hypnotic self. She makes the same statement as to the cause of her relapse as did B I. In response to inquiries she goes on to state that her name is 'Miss Beauchamp.' [Her manner at this early stage used to indicate great surprise that I should ask her name, as if both of us did not know.] She does not know anything about any other person, and expresses some annoyance at being told that she<sup>1</sup> has stated that there is another. (This talk about a 'she' evidently troubles her, as it did at the last interview, and is something she cannot understand. I take pains not to explain anything, only asking her such questions as will test her memory, leaving her in the dark as to the meaning of the questions and the existence of the other hypnotic self.) [Both B I and B II were kept in ignorance of B III for a long time.]

"Patient now, without being first waked up, is more deeply hypnotized by command. She goes into an apparently deeper trance. At once her whole manner changes. She begins to

<sup>1</sup> That is, in testing her memory for what had been said by B III.



stutter, and again speaks of herself as being a different person from Miss Beauchamp, whom as before she refers to as 'She' and 'Her.' Explains that the cause of her illness was partly the effect of the sermon (referred to by B I), and partly due to the fact that 'the person in black' (my secretary, who was taking stenographic notes) was in the room, and partly to the fact that I had bothered 'Her' (i. e., B II) at the previous sitting by troubling 'Her' with all sorts of questions which 'She' did not understand.<sup>1</sup> B II, she asserts, does not know anything of the present person talking, and when I kept asking 'Her' questions concerning things 'She' did not know anything about, it upset 'Her' very much. It also troubled 'Her' (i. e., B I) having in the room some one to whom 'She' was afraid 'She' would expose 'Her' thoughts, having been told by me that 'She' talked in hypnosis. All these things conspired to upset 'Her;' hence 'Her' illness of the past week."

It should be noticed that in this explanation the third self *also* did not make any distinction between Miss Beauchamp and B II; but spoke of Miss Beauchamp as being upset by my questions, although the disturbing questions had been put to Miss Beauchamp in hypnosis. Yet, again, it was when awake that she dreaded being hypnotized with a stranger in the room. More important is the fact that B III showed a complete knowledge of all that was said to B II, — in fact, knew all about B II. She showed an intimate knowledge of the conversation in which B II was accused by me of having made the claim that she was a distinct person from "She," and she professed at least a knowledge of her inmost thoughts and feelings. And so it was at every interview.

As a test of the memories of B II and B III, I was in the habit at each interview of asking each to repeat certain parts of a previous conversation, and to describe what had occurred during the earlier part of the interview, or during the previous interview, including insignificant details of

<sup>1</sup> That is, as if B II and B III were one and the same person.

my actions, etc. Miss Beauchamp never had any memory of what happened while she was Chris, any more than while she was B II. That was plain enough. Miss Beauchamp knew nothing of the other two. The hypnotic self, B II, on the other hand, remembered everything that she, B II, said during the preceding times when she had been in existence, and also everything about Miss Beauchamp's life. She would give at each visit an accurate account of everything that happened when Miss Beauchamp was awake, whether in my presence or at her own home. She would repeat my conversation with Miss Beauchamp, what I did when Miss Beauchamp was in the room, and so on, *ad infinitum*. She was plainly the "hypnotic self." But she was in entire ignorance of the new self, Chris (B III). She always denied any knowledge of what she had said in this new state, nor could I ever trip her up, though I set many traps. For instance, at the close of the last interview, just referred to, the new hypnotic self, Chris, volunteered to give some information on a matter connected with Miss Beauchamp's affairs, but did not complete it. This was the last thing that she said before Miss Beauchamp was awakened. At the next interview I questioned B II as to what it was she was going to tell me, as if it were she and not the new self, Chris, with whom I had been talking.

"Do you remember the last thing you said yesterday? You were going to tell me something."

"Going to tell you something? No, I was not."

"Yes, you were."

"No, I am sure. I do not remember anything."

Later in the course of this same interview Chris was obtained. The same questions were put to her.

"Yesterday you were going to tell me something. What was it?"

Chris at once showed complete knowledge of the conver-

sation and continued what she had begun at the interview in question. Thus it was shown that B II could give verbatim my conversation with herself and with B I, but nothing of that with B III. But B III could repeat that with all three selves; and so it was correspondingly with what was done at those times. So B III knew both B I and B II, although B I and B II knew nothing of B III.

This relationship may be expressed by the following diagram, the arrow indicating the direction of knowledge :

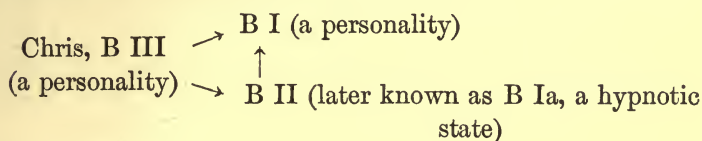

Of course Chris's memory was continuous for the times of her own previous existence; that is, for the times when, Miss Beauchamp having been put to sleep, Chris was present as an alternating personality. As to her knowledge of Miss Beauchamp, besides her familiarity with outward circumstances, she could describe the latter's inmost thoughts and feelings, her moods and her emotions, as afterwards was verified over and over again. The marked individuality of Chris's character, her insistence upon herself being a separate personality, the wideness of her knowledge, and various other even more important peculiarities which later became known made her an interesting study. Although she first disclosed her existence through the hypnotizing process, she proved to be no ordinary hypnotic self, but a veritable personality which also exhibited itself at times as an organized *subconsciousness*.

One of the most interesting features when the change to Chris took place was the sudden alteration of character, which was almost dramatic. It was amazing to see the

sad, anxious, passive B II suddenly become transformed into a new personality, stuttering abominably, and exhibiting a lively vivacity, boldness, and saucy deviltry, difficult to describe.

No longer sad, but gay and reckless, she resented any attempt to control her. For example: therapeutic suggestions given to B II were accepted with docility, but when they were tried on this new hypnotic self they were met at once by opposition. "You th-th-think you c-c-c-can c-c-control me," she stuttered, "b-b-because you c-c-control 'her.' You c-c-can't d-d-do it. I shall d-d-do as I p-p-please," etc., etc.<sup>1</sup>

Finding that this tack would not work, another was tried.

"I want your co-operation to help me get Miss Beauchamp well. Will you help me?"

"Now that is a different kind of talk," she replied, mollified, though still stuttering.

Rebelliousness and above all sauciness like this was something entirely foreign to Miss Beauchamp's character. It was clear that there were three different selves, or at least three different mental states.

Some idea of the memories and characteristics of the different selves may be had from the following extract from the notes of the next interview, May 1. It was not easy to exactly transcribe the language, and above all to represent the tone and mannerism of each. It was found that the presence of a stranger in the room was so disturbing to Miss Beauchamp, who naturally feared lest she should betray her private affairs, that it was necessary to give up the plan of taking stenographic notes. The difficulty of

<sup>1</sup> Chris, when she first appeared on the scene, stuttered badly. Later this difficulty disappeared, but in the early days of her career it was obtrusive. Sometimes she would remain silent on account of it, especially at the first moment of her appearance. She also used to keep her arms and hands in motion in a nervous way. It was as if she had not yet learned to co-ordinate her newly acquired muscles, and had general ataxia in consequence. This too disappeared later.

taking down verbatim, in longhand, a rapidly held conversation necessarily obliged a condensation of sentences, so that the style is not fairly represented in these notes, but the accuracy of the facts as brought out may be insisted upon. On May 1, the ground of April 30th was gone over again as follows:

After hearing the report from Miss Beauchamp and questioning her on various matters, she was hypnotized, becoming plainly B II.

Q. "How has Miss Beauchamp been doing?"

A. [Changing the question to the first person.] "How have I been doing? I have been doing very well?"

Q. "How has 'she' been doing?"

A. "'She'? Who?"

Q. "Don't you know who 'she' is?"

A. "You did not say."

Q. "Don't you know?"

A. "Do you mean Miss K.? No, I do not know whom you mean."

B II kept rubbing her eyes. She would not recognize the existence of any other personality than herself, nor could I get her to betray any knowledge of having, as Chris, referred to a "she."

Q. "Have you been going to sleep this past week during the daytime?" [Referring to spontaneous trances that had occurred.]

A. "No."

Q. "Are you sure?"

A. "Yes."

Q. "Have you been reading?"

A. "No."

Q. "Why?"

A. "I can't."

Q. "Why can't you? Have you been trying?"

A. "Yes."

Q. "What prevents you?"

A. "Nothing."

Q. "Do you mean you can't fix your mind?" [As already stated by her when awake as Miss Beauchamp at the interview of the previous day: page 30.]

A. "Yes, that is what I mean. I can't read — can't fix my mind at all."

Q. "What happens?"

A. "I begin thinking of all sorts of things the minute I try to read. Sometimes I throw the book down on a chair or table. I throw it down hard and closed after trying to read." [Illustrates at my request.]

Q. "Have you ever been so before this past week?"

A. "No, never."

When pressed for an explanation of her unusual action her answer was characteristic of subjects exhibiting phenomena which they cannot explain: "People do not always have a reason for everything they do." This apparently simple action had more significance than would appear on the surface. Though not open to absolute proof, it is morally certain that it was an example of a suggested post-hypnotic phenomenon and the prelude to many similar exhibitions which I actually observed. For the benefit of the uninitiated it may be explained that in suitable subjects if a suggestion is given in hypnosis that a certain action be performed later after waking, the subject will, at the appointed time, carry out the suggested idea; or perhaps more correctly, the suggested idea will complete itself without the subject knowing why he does the action, which sometimes is performed in an absent-minded way without his even knowing he has done it. Sometimes the subject enters a semi-hypnotic state at the moment of carrying out the command.<sup>1</sup>

<sup>1</sup> The following is an amusing example of this well known phenomenon. I told a subject, Mrs. R., in hypnosis, to put on her bonnet and wear it during

When Miss Beauchamp, as she and B II reported, found herself unable to read and threw down the book, she carried out a command that I had given for therapeutic purposes to Chris, unknown to the other selves. I had told Chris, rather carelessly, that she was to prevent Miss B. from reading, without suggesting how the thing was to be accomplished. Chris, who later explained the phenomenon at length, claimed to have been the author of this automatic action on Miss B.'s part, and to have taken this drastic method of carrying out my suggestion, thereby showing considerable subconscious independence, and, I think, logical reasoning. It is worth noting how sharply differentiated were the volitions of the two personalities at this early date. Later, I personally witnessed similar phenomena on numerous occasions. It may be here stated that though often, for the purposes of a continuous narrative, phenomena are noted as having occurred, on the strength of the statements of the subject, these, when important, were accepted only after searching inquiry; and secondly, examples of every phenomenon described have been *personally witnessed*, at one time or another, over and over again.

To resume: B II [hearing the scratching of my pencil taking notes]. "What are you doing?"

dinner the next day. She had no recollection on awaking of the command. Mrs. R. thus described what occurred: "As I was going in to dinner, my girl asked me what I was going out for. 'I am not,' says I; 'I am going to eat my dinner.' 'Then what have you got your hat on for,' says she. I put my hand to my head and there was my bonnet. 'Lord, Mamie,' says I, 'am I going crazy?'" "No, mother," she says, 'you often do foolish things.' I began to get frightened, but took off my bonnet and went into the next room to dinner." There the younger child similarly asked her where she was going, and called attention to her having her bonnet on. She again took it off; later when her husband entered, the same thing was repeated; but when she found her bonnet on her head for the third time she made an excuse of the stormy words that ensued to declare that she would "keep it on till she was through dinner." After dinner, being alarmed, she consulted a neighbor about it. (For further observations on the case of Mrs. R. and others, see "Boston Medical and Surgical Journal," May 15, 1890.)

Q. "What do you think?"

A. "You are scratching something, so —" [Illustrating.] "What is it?"

Q. "Don't you know what I am doing?"

A. "No, I don't know."

Q. "Are you awake or asleep?"

A. [Evidently puzzled.] "I can hear what you say and I can talk, but I can't see you." [Her eyes are closed.]

Q. "What do you infer from this?"

A. [Evidently puzzled — does not know what to answer.] "I never saw such a person as you are for asking questions."

Q. "Are you awake or asleep?"

A. [Still puzzled, but finally apparently catching the suggestion.] "Asleep, I suppose; yes, asleep."

Q. "What is the difference between you now and when you are not here?"

A. "I am asleep now."

Q. "Are you the same person?"

A. [Emphatically.] "Of course I am the same person." [This answer should be compared with the answer of Chris later given.]

Q. "Do you know everything that happens to you when you are awake?"

A. "Yes, everything."

Q. "When awake do you know everything that happens when you are asleep?"

A. "No, nothing, and I do not think it quite fair."

Q. "Why?"

A. "Because I like to know things. It is just that — [with a finger makes a sign imitating my method of hypnotizing] and I go to sleep."

Q. "Do you feel that you are exactly the same person?"

A. "Of course. Why should I feel differently?"

It is interesting to compare the general straightforward,



direct tone of these answers with those of Chris, now to be given. The change is easily recognized.

B II is now more deeply hypnotized, — to use a common but incorrect expression,<sup>1</sup> — and Chris appears, as shown by the usual change of manner.

Q. "Why do you let your arms move so?" [Patient is fidgeting and moving her hands and arms. Shakes her head as a negative response, and keeps her lips tightly closed.]

Q. "Why don't you speak?"

A. "I d-d-d-don't want t-t-to."

Question repeated.

A. "I d-d-d-d-don't know."

I ask her another question. She replies by shaking her head in the negative, as if unable to answer.

Q. "Why do you stutter?"

A. [Annoyed.] "I d-d-d-d-don't st-st-st-stutter. If I ch-ch-choose t-t-to st-st-stutter I shall."

Q. "Why have you suddenly changed?"

A. "I have not ch-ch-changed at all."

"You were not stuttering a minute ago."

"I was n-n-not t-t-t-talking a m-m-m-minute ago; 'She' was."

Q. "Who is 'she'?"

A. [Showing irritation and annoyance.] "I won't g-g-g-go through that n-n-nonsense again. I t-t-told you t-t-ten d-d-days ago. If you d-d-don't know any better now I sha'n't t-t-tell you."

[These answers were given with a good deal of resentment.]

Q. "What is your name?"

A. "I sha'n't t-t-tell you."

Q. "Can't you for politeness?"

<sup>1</sup> The correct way of describing the process would be, B II was by a device changed to Chris.

A. "I d-d-don't ch-ch-choose t-to be p-p-polite. I have t-t-told you many t-t-times."

Q. "Why do you stutter?"

A. "I d-d-don't stutter — only something wrong with my t-t-tongue."

Q. "Did you ever stutter in your life?"

A. "No, and *She* did not either."

[It will be noticed how quick B III was to make the distinction between herself and "she" at this time. I here tried to catch her by the use of the word "you," but failed.]

Q. "Tell me once more your name."

A. [After some hesitation and thought.] "Chris L." Her real name, we will say, is Christine L. Brown.]

Q. "What more?"

A. "Th-that is all. You had b-b-better make a note of it and remember it."

Q. "What does L. stand for?"

A. "N-n-not at all n-necessary th-th-that you sh-should know."

Q. "Does it stand for Brown?"<sup>1</sup>

A. [Irritated.] "N-n-no, her name is Brown. I t-told you th-that yesterday."

Q. "Well, I shall call you Miss Brown."

A. "If you ch-choose t-t-to c-c-call me Miss Brown you c-can. I shall have n-nothing t-t-to d-do with you."

Q. "How did you get the name of Chris?"

A. [Objects to answering, dodges the question and evades — then says:] "You th-think you c-can make me t-tell everything b-b-because you c-c-can make her."

I change my tone, upbraiding her for not being frank and then explain that my only object is to test her memory; I add that I know how she got it, and she knows that I

<sup>1</sup> That is, I mentioned the real name of Miss Beauchamp for which "Brown" is here substituted.

know, and I know that she knows, so she might as well tell, as it is merely a test of continuity of memory. Subject becomes more placid and says: "You suggested it to me one day, and I remember everything." [This is correct.]

The peculiar character traits manifested by Chris, which distinguished her so unmistakably from Miss Beauchamp, both when awake and when hypnotized as B II, naturally gave rise to the suspicion that Chris might be an artificial product, the result of her own self-suggestion, or simply hypnotic acting. It seemed possible that Miss Beauchamp might as a result of reading have acquired some information about the bizarre behavior of certain types of secondary personalities, and that the ideas thus originated might have developed themselves afterwards in the hypnotic state in such a way as to lead Miss Beauchamp in this state to act out a character after some preconceived theory; or, if not deliberate acting, as the psychological development of auto-suggested ideas. On this theory Miss Beauchamp was closely questioned on her past reading and knowledge of psychological phenomena. Nothing was elicited, however, that in any way supported this theory. I never discovered that she had any knowledge of the literature of abnormal psychology, or knew anything about modern researches in this field of inquiry, including hypnotism, multiple personality, etc. Thinking possibly that she had read something which might have been forgotten in the waking state, B II was similarly catechised, and finally Chris was put through the same cross-examination. But in no state was there any memory of Miss Beauchamp's having read any book or acquired any information which could have worked itself out as suspected. The final developments of the case, as will appear, completely negatived such a hypothesis.

The psychological relations of B II to the waking con-

sciousness differed in one very important respect from those of Chris to the same. I am not here concerned with the *proofs* of this difference, or with the psychological phenomena themselves. This evidence will appear in the course of this study. I am at present concerned merely with the conditions under which the different hypnotic states or personalities developed, and their varying peculiarities of character. Yet it will aid in the understanding of the various phenomena exhibited if certain psychological relations, which at this time were only hypothetical, but which were later proved, are mentioned.

It has been stated that the hypnotic state B II always spoke of herself as Miss Beauchamp, and never recognized any distinction of personality between the two states. In character they were the same. Now nothing was ever observed, at this time or later, to indicate that B II, as such, had a persisting and continuous existence during the waking state of Miss Beauchamp. It is frequently assumed by writers that the hypnotic consciousness persists, as a more or less systematized self, during waking life. This conception is expressed in such phrases as the "subconscious self," the "hidden self," etc., which are loosely used as the equivalent of the "hypnotic self."

It is a much more difficult matter than would at first sight seem to be the case, — indeed, much more difficult than is generally supposed, — to prove the existence of a secondary consciousness during the *normal* waking life. This idea that the hypnotic self persists after the subject wakes, as a concomitant subconscious self, — that is, a self which has an existence concomitant with, but unknown to, the waking personal consciousness, — has grown out of certain suggested post-hypnotic phenomena, and also from what is observed in certain hysterical states. Post-hypnotic phenomena have been already described. Still bet-

ter our illustrations of subconscious mental action are those indicating arithmetical calculation, first devised, I think, by the late Edmund Gurney in England. Successful experiments of this kind I have been able to obtain with Miss Beauchamp. To make such experiments, a suitable subject in hypnosis is told, say, to add or multiply certain figures, or make some other calculation, and perhaps give the result at the end of a certain period, say eighteen hours, which would again require the counting of the passage of time. The subject is instantaneously awakened before he could possibly make the calculation, which is worked out subconsciously without the personal knowledge of the subject, and later the answer is given in one of various ways in response to the command.

This problem of the sub-conscious self we shall consider later in another place (Part III). I will here merely point out that all such phenomena are artifacts, the artificial products of suggestion (just as hypnosis itself is an artificial dissociation), and in no way indicate that *habitually* and *normally* there is a subconsciousness so elaborate that it can be regarded as in any sense a self; or, when a person can be deeply hypnotized, that the whole of the stream of consciousness which constitutes hypnosis — the personal hypnotic consciousness — *persists* as such after waking. This is by no means a denial that some elements of the hypnotic consciousness, some ideas or emotions may *not* become by artifice or other influence dissociated and then *persist* during the waking state as a subconsciousness. On the contrary such may be shown to be the case. It is a denial that, under normal conditions, that stream of consciousness which constitutes the personal self during hypnosis persists as a whole, or in the large sense of a self, after waking; or that we may justifiably speak of the hypnotic self as a second normal hidden self. The exact mechanism of artificial subconscious phenomena is somewhat complex,

but in a general way it is sufficiently correct to say that the suggestion dissociates a limited number of mental states (ideas, etc.), from the remainder of the personal consciousness, and these isolated dissociated ideas take on what is called "automatic" activity, and carry out the suggestion subconsciously. They may and often do temporarily rob the personal self of a part of its field. The dissociation is only temporary, and as soon as the experiment has been accomplished, synthesis again takes place, or the activity of the dissociated ideas subsides. It is true that when the subject is put again into hypnosis he remembers the subconscious thoughts dissociated by the experiment. He remembers his arithmetical problem. He may remember how he did it and why he did it; but he likewise remembers his waking thoughts,—the thoughts of the personal self,—and therefore, if continuity of memory be taken as a criterion, it would show that the hypnotic consciousness is identical with the waking consciousness as well as the subconscious. But it cannot be identical with both. The real fact is that when the subject is thrown into hypnosis the artificially created subconscious *memories* become amalgamated with the hypnotic consciousness, and therefore the previously subconscious thoughts are remembered by it. When he wakes up these memories are again dissociated, that is, forgotten in the sense that they cannot be awakened, synthesized, and recalled.

The erroneous assumptions in the notion of the "hidden self" are that *normally* and *habitually* there is a persistent hypnotic *self*, that is, persistent during the waking state as a subconsciousness, and that this self is a definite entity occupying a definite place in the mental economy. It implies that whatever subconscious states may be present normally are coextensive with the whole consciousness which makes up the personal self during hypnosis. This is the fundamental error. The hypnotic self is ordinarily a well devel-

oped personality; it is a great complex grouping of conscious processes constituting what is called a self, in fact *is* the primary self shorn of some of its faculties. Therefore if it persisted as a *self* after waking, we should have a paradox. The truth of this will be recognized if we consider the lighter stages of hypnosis. Here the disintegration may be so slight that the hypnotic self may have such a large field of consciousness as to be approximately equivalent to the waking self. Surely such a hypnotic state cannot exist as an extra self after the subject wakes.

On the other hand, in certain *hysterical states*, such as anesthesia and fixed ideas, there is a persistent dissociation of consciousness, meaning a persistent subconsciousness of a greater or less extent, ranging from a few isolated sensations to fairly large groups of ideas. Sometimes these subconscious ideas spontaneously manifest themselves in certain outbursts, and thus reveal their presence. At other times this subconsciousness, by suitable devices, can be tapped and shown to exist. The lost sensory perceptions, which constitute the anesthesia, can be shown to be retained subconsciously. The subconscious "fixed ideas" may sometimes be shown to be a part of a large group of ideas,—so large as to constitute almost a second personality. Such states, then, exist concomitantly with the waking consciousness, coexist with it, and indicate a veritable doubling of the mind. Such a subconsciousness, as will appear, was Chris.

But even a subconsciousness of this kind is not identical in extent with the hypnotic consciousness. The subconsciousness, so long as it is subconscious, has a much narrower field; it does not (excepting in crises) have control, for instance, of the arms and legs, or the speech faculties, and it is not possessed of the intellectual capacities which the subject in hypnosis possesses. When the subject is hypnotized and put into a particular state, the subcon-

consciousness may become fused with this particular hypnotic consciousness, and, if so, its contents are then remembered and the whole may then form an alternating personality.<sup>1</sup> *A subconsciousness is a particular group of mental states, dissociated from but concomitant with the personal self*<sup>2</sup>; but we have no way as yet of experimentally determining how extensive this subconscious group may be. The ordinary methods of tapping the subconscious stratum (automatic writing, speech, etc.) are fallacious, as for the very purpose of manifesting itself the subconscious tends to rob the waking self of part of its ideas.

Now as a fact, B II never showed any evidence of persisting as a concomitant subconsciousness. If you asked her what became of herself when Miss Beauchamp was awake as B I, she would answer she did not know. Did she exist at such times as B II? No, she was waked up, that was all: she was B I: she was the same person. The question itself, in her mind, implied an absurdity or wrong conception. She was B I; how then could she otherwise exist at the same time, and as somebody else? B I went to sleep, and we called her B II. Nor did B II have any memory of having had mental experiences when B I was awake, other than those of B I, including, of course, the experiences which B I had had, but had forgotten.<sup>3</sup> Nor were there any spontaneous manifestations of subconscious mental life, like automatic writing, speech, or obsessions, which could be traced to a persistent B II. B II, in other words, was B I "asleep," and was limited

<sup>1</sup> It may then be hastily, but unwarrantably, assumed that the whole alternating personality persists subconsciously after waking, instead of only a limited number of concomitant states.

<sup>2</sup> Janet's "Léontine," in the case of Mme. B., may be taken as a good instance.

<sup>3</sup> This statement does not include the isolated subconscious states probably habitual to every normal mind, and which B II remembered. An investigation showed that there were such states, but that they belonged to B I. To consider this question here would involve too wide a digression.



to that state. It was for this reason that B II was later (Chapter XVIII) termed B Ia, which expresses this relationship; while the term B II was transferred to another hypnotic state which was afterwards discovered. This is important to bear in mind.

With Chris, on the contrary, it was different. From almost the very first her language implied a concomitant existence for herself, a double mental life for Miss Beauchamp. She always spoke as if she had her own thoughts, perceptions, and will *during the time while Miss Beauchamp was in existence*. As an instance of this may be taken the conversation when Chris was questioned to discover whether Miss Beauchamp had read any book about multiple personalities, and also to determine whether the whole range of ideas gathered by the reading of the waking self, B I, was retained in Chris's mind. It was afterwards shown that the latter was only in part the case, but her answers implied coexistence and parallelism of thought, for she explained certain lapses of knowledge by asserting that ordinarily, as she herself was not fond of books, she did not pay attention while Miss Beauchamp was reading; but that when she did so, which was only when interested, she could understand and remember the text; that she liked different books from those Miss Beauchamp liked, and that she understood some things Miss Beauchamp did not, and *vice versa*.<sup>1</sup>

<sup>1</sup> It may seem a contradiction to say that Chris knew Miss Beauchamp's thoughts, and yet did not understand all that the latter read. The distinction is comprehensible, though it proves a limitation of Chris's field of consciousness relative to that of B I, and shows that it was not as full and complete as the latter's. A distinction must be drawn between Miss Beauchamp's ordinary thought-knowledge and the knowledge which she acquired as a matter of learning, such as French, shorthand, etc. The former, Chris was fully conscious of, but beyond a few words she did not know French, though Miss Beauchamp read it easily. The same was true of shorthand. Indeed, later, one of the personalities wrote shorthand in her diary so that Chris should not understand what she had written; and I was in the habit of using French to convey information which it was important should be concealed from Chris.

A claim of this kind, to be able to pay attention or not as she pleased, when the waking consciousness was reading, required the coexistence and simultaneous action of two distinct and unlike streams of thought in one individual. For a second consciousness to be interested or not, to pay attention volitionally (that is, to will) or not, while the first consciousness is acting, for the one consciousness to understand when the other did not, and *vice versa*, necessitated two *coexisting* consciousnesses. The fact that Chris remembered what Miss Beauchamp read did not necessarily imply coexistence. A person in hypnosis may remember what occurs in the waking state, though the two mental states are successive, not coexistent. Chris's claim meant parallelism of thought. The idea that Chris might continue her existence as a subconscious personality rested on nothing more than her own statements at this time. It became an important psychological problem that required investigation and to be proved or disproved. It should be remembered that up to this time Chris had had no independent existence excepting in my presence, and if she had done any independent reading it must have been as a subconscious personality. Continuing the inquiry in regard to this point, I had accused Chris, in order to draw her out, of not being able to understand what Miss Beauchamp read, or to read independently, subconsciously and contemporaneously with the waking self.

"What you mean to say is, you can't read."

"I won't read."

"You can read, then?"

"Yes, but won't."

"Why?"

"I don't like it. I won't pay attention when she reads."

"Never?"

"Only once in a great while."

"Do you understand what 'she' reads?"

“I understand some things. I pay attention to some things, and not to others; sometimes, though, when I do pay attention I don't understand, but she does; and sometimes she does not understand and I do.” (At this interview her memory was tested for a book which Miss Beauchamp had read, and was found to be the same as the latter's.)

Such statements in themselves of course have no scientific value as proof; a memory of a previous subconscious personal existence might well be a delusion. Nor would the fact that she remembered certain previous subconscious ideas — ideas not possessed by the waking self — prove the subconscious existence of a “hidden” Chris, any more than does the memory possessed by the ordinary hypnotic self prove, as I have already pointed out, the subconscious persistence of that self. Indeed, no hypnotic self, that has not exhibited subconscious manifestations, has ever claimed a persistent subconscious existence. Certainly B II did not. If Chris's belief was a delusion, it may be asked how did she come by it, seeing that none of the other personalities or hypnotic states had such a belief. It certainly was not suggested to her, for in the beginning I always denied the truth of it. Nevertheless, in spite of my denials, Chris always refused to admit the identity of her own personality with that of B I, whether as a hypnotic or subconscious personality. “We are not the same person,” she would insist; “we do not think the same thoughts;” meaning when B I was present. In other words, she claimed, in her own peculiar language, to be always present as a subconsciousness.

When asked the direct question if she continued to exist as a separate and distinct self while B I was awake she asserted positively and unqualifiedly that she did, and maintained that at such times her own contemporaneous thoughts ran in a different stream from those and were

totally unlike those of her other self whose inmost thoughts and feelings she then knew.

This question of Chris's being a coexisting as well as an alternating personality, was more difficult to prove off-hand than might seem at first sight to be the case. Experimental methods were unsatisfactory. It was, to be sure, easy enough, as I soon found, to obtain experimentally automatic and post-hypnotic phenomena, like that of Miss Beauchamp's throwing down the book which she was trying to read, and even to communicate with Chris while a subconscious personality. Numerous observations of this kind might be cited, all showing the existence of concomitant states, and the doubling of consciousness; and it was easy to identify the second personality communicated with as Chris. But a doubling obtained experimentally might well be explained as an artifact and the product of suggestion. Spontaneous phenomena were essential for proof. These, and plenty of them, and of every variety, were soon forthcoming, and proved conclusively that there were moments when there was a veritable doubling of consciousness. They will be found running through this study.

To admit that Chris existed even momentarily as a co-conscious second self while Miss Beauchamp was awake may seem inconsistent with the statement made above that normally the hypnotic self does not persist as such during the waking state. I must ask the reader to suspend his judgment in this and several other matters of this kind until the case has been more fully unfolded. We shall soon see that Chris was not simply a hypnotic self, but she was distinctly a pathological condition, both as an alternating and as a subconscious self.

But if it shall be found that Chris coexisted as a second self during any part of B I's life, there still will remain two questions of psychological importance: first, what was the extent of the field of her co-conscious life? That

is, when she became a co-consciousness, did the mass of her mental processes remain unchanged, or become augmented, or did it dwindle to elementary proportions? Second, was her subconscious life continuously persistent during that of B I, or did it come into existence only sporadically under certain conditions when aroused by special excitants? These questions are difficult to answer. Chris's own statements, being based on introspection, cannot be accepted as reliable evidence, though they are free from the artifacts which experimental methods are liable to produce. For the present we leave aside this portion of the problem until the data for any kind of subconscious life have been presented.

## CHAPTER IV

### THE BEGINNINGS OF AUTOMATISM

IN these early days of Chris's appearance she was inclined to be boastful, or at least to claim a superior intelligence to that of Miss Beauchamp, whom she scorned. "She is a stupid chump," she would say, revelling in the slang as a child might. She also, when driven into a corner with questions, sought to evade, rather than appear ignorant or incapable, so that it was necessary to take some of her assertions with a grain of salt. This was particularly the case when her powers relative to those of Miss Beauchamp were in question. Later, when we came to know each other better, she made a solemn promise never to deceive or mislead in matters of serious inquiry. This promise she rigidly kept, and, excepting when it was a matter of pure fun, I do not know any deliberate falsification of fact made by her. Often she sought, as will appear, to throw dust in my eyes about her own culpable actions, and often she would refuse information, but when it came to actual confession I always got the exact truth.

It is a curious fact that from the very beginning of her career Chris showed an intense dislike and contempt for her other self. Almost from the first words she spoke, this attitude was manifested. Even during the first days, before she was allowed to open her eyes, and before she developed an independent life, as afterwards came to be the case, she lost no opportunity of ridiculing Miss B.'s love of books and religion, and the intense idealism which

caused her to respond to life with unnecessary emotionalism. "Her" head was in the clouds, Chris declared, and "her" intensity of thought she called "mooning." She thought it all "stupid" and "silly." The contrast between the attitude of Chris and that of B II toward their waking self was very striking. If I asked B II who she herself was, with quiet dignity she would say, "I am myself, Dr. Prince," or "I am Miss Beauchamp," and she always gave expression to the same feelings and ideals as when awake. But in Chris, from her first entrance, every taste and ideal had become changed; and she had no respect for those of the person to whom she found herself tiresomely linked in life.

The difference between the ideals of Miss Beauchamp and her subconscious self offered a constant and entertaining study. One of Miss Beauchamp's prominent characteristics is a sense of responsibility and duty. Amusement plays no part in her conception of life, owing to certain circumstances of her environment. However much one might from a moral point of view admire this characteristic, there was a delightful attractiveness in Chris's absolute disregard of responsibility; she was a child of nature. Though it was not until much later in her career that she had an opportunity to put her own ideas into practice, and to please her own tastes (which she did with a vengeance), she early let her sentiments be known. It was contempt for Miss Beauchamp's ideals which led her to try to give the impression of mental superiority. She had, as we shall see, a certain plausible excuse for this, in that, as a subconscious personality, she *observed things, when Miss Beauchamp was absorbed in thought, which the latter did not observe, and remembered much that had been forgotten or never known by her.* When I say that "as a subconscious personality" she did this I am stating an interpretation of the phenomena which were later observed rather than the

actual facts themselves. The facts were that Chris remembered and described having seen and heard much of which Miss Beauchamp was ignorant; such as the face of a passer-by or sounds in the street. This could be experimentally demonstrated. The now generally accepted interpretation of such phenomena is subconscious perception, and there seems to be no way of interpreting the perception which Chris remembered excepting in this way, but it is well to bear in mind that it is an interpretation, otherwise there is danger of statements of fact becoming too broad. In this sense she also could subconsciously interfere with and influence Miss Beauchamp's actions, as when she made her fling down the book and diverted her thoughts to prevent her from reading. Chris thought this was quite sufficient to constitute mental superiority. To draw her out I used to insist that she did not know as much about the psychology of Miss Beauchamp's mind as she asserted. This would annoy her and put her on her mettle to prove her claims. On the first occasion when so taunted she replied peevishly, "You would be more sensible to be friends with me than to say I don't know things when I do," and this I found to be the case. Most of Chris's peculiarities of conduct came from her thoroughly childlike character. Her point of view and knowledge of the world being those of a very young girl, she loved to be thought wicked, though her ideas of wickedness were youthful. She pretended to like French novels, though she could not read French and knew nothing about the literature.

In the course of the interview of May 1, reported in the last chapter, Chris remarked that she smelled the odor of a cigarette which I had been smoking. I offered her one. Delighted at the idea, she accepted, but smoked the cigarette very clumsily. The fact that smoking is something absolutely repugnant to Miss Beauchamp's tastes added to



Chris's enjoyment. Her manner was that of a child in mischief.

"Won't she be cross?" she laughed.

"Why?"

"She is not in the habit of smoking cigarettes. *I* shall smoke though."

Miss Beauchamp, when awakened, entirely ignorant of what she had been doing, complained of a bitter taste in her mouth, but could not identify it, and I did not enlighten her. At the next interview I remarked to Chris, "Was n't it funny to see Miss Beauchamp when she tasted the tobacco in her mouth, and did not know what it was?"

Chris laughed and thought it a great joke. "Yes, she thought you had been putting quinine in her mouth, but did not dare ask you." This remark, later verified by Miss Beauchamp, was one of many which showed Chris had knowledge of Miss Beauchamp's thoughts.

The sequel to this episode was amusing. At a later period I was engaged in making an experimental study of visions,<sup>1</sup> and for the purpose had Miss Beauchamp (B I) look into a glass wherein she saw various visions of one kind and another. That is to say, the phenomena of so-called crystal visions were easily produced, and she proved an excellent subject. These visions were, for the most part, reproductions of past experiences. In one experiment she was horrified and astonished on looking into the globe to see the scene of the cigarette rehearsed in all its details. She saw herself sitting on a sofa — the identical sofa on which she was at that moment seated — smoking cigarettes. Her eyes, in the vision, were closed. (Chris's eyes were always closed at this time.) It was amusing to watch the expression of astonishment and chagrin with which she beheld herself in this Bohemian act. She

<sup>1</sup> Brain, Winter Number, 1898.

indignantly repudiated the fact, declared it was not true, and that she had never smoked a cigarette in her life. The childlike expression on her face in the vision—Chris's face—which she characterized as "foolish" also annoyed her.

The ease with which visual hallucinations were induced in Miss Beauchamp indicated great suggestibility, a fact of considerable significance, as we shall see. For the present, however, we are concerned only with the individual characters of the hypnotic and subconscious states.

Continuing the conversation about French novels and wickedness, Chris remarked laughingly, "She does not enjoy wickedness. I do. She thinks she is going to be a sister. She won't as long as I am here."

"Why?"

[With an expression of disgust on her face.] "I have a great objection to having nothing to eat, and doing things I am told to do, and going to church and being preached at. I have other things to do."

"What?"

[Laughing.] "To smoke cigarettes."

For the first two months after Chris's appearance, she used to remain seated on a sofa before me with her eyes closed, as did B II. She early developed what at first appeared to be an inconsequential trick of rubbing her closed eyelids, as if to remove an uncomfortable feeling. When asked why she did this, she explained that she wanted to get her eyes open to see. She could not voluntarily open her eyes, owing apparently to the original suggestion producing hypnosis, including as it did the idea of closure of the lids. Nevertheless, there was this difference between this personality and B II. The latter was ready to accept any reasonable suggestion without remonstrance, but Chris from the outset showed a will and individuality of her own, which were in no way sub-

ject to anybody else's influence. Now she sought to get her eyes open, taking every opportunity to rub them when not prevented. She wanted to see; she had a "right to see" and "would see," she declared, and complained because this was not allowed. It was forbidden on the theory that, if she succeeded and could thus add true visual images of her surroundings to her *own* consciousness, these same images when seen by Miss Beauchamp would by association tend to bring Chris spontaneously. This afterward came to pass, as there is reason to believe. But though her eyes were kept closed, she was lively and vivacious, and very alert to "catch on" to everything going on in the room. As we became better acquainted, she gave vent to her spirit of fun and irresponsibility.

At this time some phenomena were reported which were the prelude to a long series of events which are difficult of interpretation excepting as interferences by the subconscious personality, Chris, with the mental processes of the primary or personal consciousness. Up to this time, with one exception, the manifestations of the mental life of that group of mental states which we have dubbed Chris, were limited to the short periods when, as an unexpected result of the hypnotizing process, the waking self was transformed into this second<sup>1</sup> personality. During those periods Chris was, in the slang of the street, "It." For the time being there was no other personality, and she had the field to herself. The one exception just referred to was the few post-hypnotic phenomena, artificially induced. Post-hypnotic phenomena, as already pointed out, are manifestations of a "doubling of consciousness," artificially induced, of a kind to form two more or less independent mental systems. The independent activity

<sup>1</sup> Although labelled B III, she was a *second* personality; as B II is, more correctly, only a hypnotic state of B I. The distinction between a hypnotic state and a personality is psychologically arbitrary, but practically useful.

of each system produces the phenomena. But such phenomena, as ordinarily brought about, are not spontaneous, but the result of artificial interference; they are of consequence psychologically in that they show the ease with which even normal minds may be split in two.

The strange behavior now reported by Miss Beauchamp embraced phenomena which were entirely spontaneous. Their significance, when scientifically interpreted, consisted in the fact that they were evidence of a duality of the mind, and the contemporaneous activity of the two minds, at one and the same moment. Further, the content of the phenomena implied considerable will and intelligence in the second mind. At this date, of course, the truth of the phenomena depended entirely upon the statements of Miss Beauchamp and of Chris; but at a later date I had opportunities, over and over again, — a hundred times, I might say, — personally to witness similar and even more pronounced “phenomena of automatism,” as they are called. These early beginnings of automatism are mentioned here in order that the conditions, under which the development of the personalities in this case took place, may be appreciated, as well as the entirely spontaneous character of the phenomena. At this time, and indeed up to a much later period, Miss Beauchamp knew nothing of her dual self, and nothing of what took place in hypnosis. She knew she was hypnotized, but not a word was said to her of her own behavior in hypnosis, either as Chris or B II. Consequently, when she was the victim of subconscious action, she was at a loss to understand her own conduct.

*May 11.* “Miss Beauchamp reports that she has been perfectly well since last here, two days ago; but states that she has been doing a most extraordinary thing, namely, telling frightful lies; and the worst of it is she does not care at the moment though she afterwards feels intensely mortified. She

has, however, been telling these lies to only one person, her friend, Miss K. Yesterday, while riding in the street car, Miss K. asked her where Mrs. Z. lived [Mrs. Z. is a very wealthy lady, prominent in society, who occupied a beautiful place in the suburbs]. Miss Beauchamp immediately pointed to a squalid little house by the roadside. On Miss K. expressing surprise that Mrs. Z. should live in such a poor sort of house, Miss Beauchamp explained by saying that Mrs. Z. had put all her money in the Five Cents' Savings Bank, and, through the Bank's failure, had lost it, and that she was now economizing. Miss K. looked at her in a most surprised way, as if trying to make her out, but said nothing. Miss Beauchamp says that she tells a great many lies of this kind to Miss K., and seems at the moment rather to enjoy doing it. Declares that she has not been in the habit of telling lies, and that it is foreign to her nature.

“*Hypnosis.* At once put into the state of B III, who stutters as usual. When asked why Miss Beauchamp told the lies promptly replied with glee: ‘I made her do it. I made her say that about Mrs. Z’s house,’ etc. It was no end of fun, she thought, and she was going to do it again. ‘I make her do all sorts of things,’ she boasted; ‘I made her drink three glasses of wine last night,— she never drinks but one,— and then I tried to make her talk and tell everything she knew, but she would n’t. I could not make her do it, but I tried.’ Chris is in high spirits over her practical joke, and is full of fun. She is ordered to desist from such things. At first she rebels, but finally assents.”

This promise was not kept, for:

*May 12.* “Miss Beauchamp reports that she still tells ridiculous lies to Miss K.; does not understand why; her lies are palpably untrue, and Miss K. must know them as such. Curiously enough, she finds a certain sort of delight while uttering them. Miss K. thinks she has changed very much in character. Says that she also contradicts Miss K., instead of accepting without hesitation all she says, as formerly. In reply to question as to her attitude of mind toward Miss K.,

says she is conscious of a certain feeling of bravado and antagonism, apparently representing a desire to show her independence."

Chris must be acquitted of all culpability on account of this last mental attitude. I was the culprit, for it was an artifact, a phenomenon of post-hypnotic suggestion, and illustrates the influence of ideas originating in this way. On April 24 Miss Beauchamp had complained of the strong influence which Miss K. had over her, — making her do things against her will, etc. This influence Miss Beauchamp appeared to feel very keenly, and resented. Accordingly, a counter-suggestion was given to B II, (which of course was unknown to Miss Beauchamp), that she should be under nobody's personal influence. This had apparently worked itself out in the way reported.

Mrs. X. is a great friend of Miss Beauchamp; one whom she idolizes and looks up to with the greatest respect and veneration, amounting almost to reverence. She was therefore much disturbed to find herself telling a lot of hardly respectful nonsense about Mrs. X.'s husband, of which the following memorandum is made in my notes. It shows Chris's idea of fun, and her love of practical jokes — always on Miss B.

*May 16.* "Miss Beauchamp reports that she is still telling fibs. For example, she told Miss M. that Mr. X. was a great admirer of Swinburne, and had busts of him all about the house; that he had named his baby Algernon Swinburne X.; that this baby was boneless; and that Mr. X. fed him and Mrs. X. on nothing but oatmeal, using up all the samples he had in the house. Miss Beauchamp is much horrified at telling such nonsense, but does not seem to be able to help it; cannot understand why she does it; more than this, she tells such pure nonsense that she feels it mortifying."

Phenomena of this kind are psychologically known as *impulsions*. The subject is compelled to do or say something against his own wishes and inclinations. Sometimes, indeed, he is horrified at the impelling idea, from which he recoils, and often seeks protection against himself. Sometimes — and of this we shall later see examples — it is not so much an impulse to act, as an obsessing idea which possesses his mind; an *imperative idea*, or *obsession*. These impulses and obsessions, being outside the will, are types of automatisms. Their genesis is not always the same, but they may have their origin in subconscious ideas which exist unknown to the personal consciousness, and which break out from time to time in eruptions, and then invade the field of the waking consciousness. Miss Beauchamp's lies plainly had their origin in another consciousness, whose thoughts were hidden from her own.

It may be pointed out here that these impulsions to lie differed in one respect from similar phenomena which can be experimentally induced in states of abstraction or extreme absentmindedness in some hysterics, and which I have often evoked in Miss Beauchamp's case. Miss Beauchamp was conscious of her automatic thoughts and speech, but in a second class of impulsive phenomena the subject is entirely unaware of what he has said or done. The subject, at the moment, goes into a condition of abstraction (dissociation), during which the automatic speech or writing is performed. The subject then is neither conscious of the ideas which gave rise to the automatism, nor of the words spoken or written. The personal consciousness does not hear its own voice because of the temporary division of its own consciousness. We shall later find examples of this.

In this connection an exceedingly interesting point, which I will not pass over without at least calling attention to it, is the relation between Miss Beauchamp's

thoughts and her compulsory (automatic) language, as well as the relations between Chris's thoughts and the speech centres. Did Chris directly make use of the speech centres, and do the lying directly? and, if so, what were Miss Beauchamp's thoughts at the time? Or, did Chris do it by influencing Miss Beauchamp's thoughts, so that the latter did the lying directly? When interrogated, Chris frankly said she did not understand the relations between herself and Miss Beauchamp psychologically; that when she made *her* talk she (Chris) "simply talked, that was all," and then Miss Beauchamp thought the things she (Chris) said. This corresponds with what is known of some types of automatic writing.

Assuming this statement to represent accurately the facts, and that Chris at such times is some sort of a contemporary dissociated subconscious mentality, this would seem to mean that the act of speaking (or functioning of the various language centres) aroused in B I the correlated thoughts which were identical with, or part of those of, the subconscious mind. As further evidence of this may be cited the fact that Miss Beauchamp while talking experienced in a mild way the delight which was plainly Chris's so that the correlated emotion was incorporated along with the thoughts. The same kind of phenomenon may be observed sometimes in automatic writing, although most subjects are not aware of what the hand is writing. Mrs. H., a patient of mine, and an excellent automatic writer and speaker, becomes conscious of what the hand is writing the moment the words are about to be written, although a second before she had no idea of what they would be. It is the same with speaking. The written and spoken ideas thus become so incorporated with her own ideas that she is unable to determine whether she is responsible for them or not. The same awakening of consciousness of the subconscious ideas is true of Fanny S., whose anesthetic hand



automatically records the number of pricks given to it. This subject also describes by automatic speech objects placed in the hand.

*May 17.* "Reports that she is feeling perfectly well, and considers herself cured; has no fatigue to-day, although she did not go to bed until three o'clock this morning; still tells fibs."

After this Chris got tired of the joke of making Miss Beauchamp tell fibs, but it was not long before she adopted new tricks to worry her waking self.

## CHAPTER V

### INSTABILITY AND SUGGESTIBILITY

**I**F the condition of Miss Beauchamp at any particular moment could be taken as a criterion, the assertion made by her at the last interview, that she was physically well, might by the superficial observer be accepted, so great was her improvement and so free was she from disabilities of the flesh at this particular time. The intense fatigue, which had made every task by day a painful effort, the insomnia, which increased the fatigue of the day and forbade relief even at night, the neuralgic pains which nagged at her poor tired body, and the other various neurasthenic symptoms had gone. It seemed as if at last she might be able to take an active part in life.

But a closer study showed that this physical restoration was deceptive, and did not rest on a solid basis. It was easy to demonstrate a condition of nervous instability which was in marked contrast with the improved physical health, and which seemed to offer a paradox for solution when one tried to understand it. By instability, I mean that almost any emotion of an unpleasant kind, or sensory impression, that happened to be associated in her memory with past emotions, was capable of re-exciting all her physical infirmities and bringing all back in a jiffy. She seemed to be still the victim of a series of little nervous shocks — sort of railroad accidents — which produced the little attacks of “traumatic neuroses” of which I have spoken.

The “symptom-complex,” as our German confrères like

to say, was easily understood; but it seemed strange, almost paradoxical, that an apparently physically normal, or approximately normal, individual could be so "broken up" by such slight causes. This slang phrase expresses with scientific exactness what really occurred. "Disintegrated" is the psychological term. Miss Beauchamp became from moment to moment psycho-neurologically disintegrated, so that all sorts of automatisms and perverted reactions to the environment were permitted to the nervous system. This condition is pathologically hysteria, but is frequently mistaken for true neurasthenia as the symptoms simulate closely those of real exhaustion. In fact, a wide experience has convinced me that a large proportion of the cases which ordinarily pass under the name of neurasthenia — a fatigue neurosis — are in reality hysteria, and more properly should be designated as hysterical neurasthenia. Certainly every practitioner will recognize this condition of *instability*, which is a marked feature of hysteria, as one which he has seen in minor degrees among his so-called neurasthenic patients. The peculiarity in Miss Beauchamp's case consisted in such attacks coming out of a clear sky, no matter how well she might appear to be; and in the exceedingly slight psychical causes which induced the attacks. In consequence of her reticence the degree of her instability was discovered only gradually. Sensations and memories associated with some distressing past event particularly tended to re-excite the original emotion, and the emotion, with shock-like suddenness, produced its disintegrating effects and outbursts of symptoms. Witness the following instance:

One day (May 6), Miss Beauchamp appeared with a dejected fatigued look upon her face. "It is evident that something has gone wrong. In obedience to directions, she brings a written report, according to which it appears that she felt perfectly well yesterday up to dinner time, when, while she was in a res-

aurant, dark clouds came up; on going out she got the idea that a thunderstorm was coming; was stricken with terror; had palpitation, nausea, hot and cold feelings, and sinking feelings; felt as if she could not run home fast enough, but forced herself not to run. When she got home the old neuralgic pains in her head and side returned; these were severe, and accompanied with very great fatigue. All these symptoms lasted about two hours, and were followed, after reading a book, by depression, which was ascribed to the book. Lay awake until twelve; woke twice after that with 'nocturnal palsy;' this she described as not being able to move a single muscle, not even her eyes, and having no feeling throughout her whole body; this lasted five or ten minutes; has often had these attacks. To-day feels poorly; has some nausea, but no pain; very tired and good-for-nothing. States she has great fear of thunderstorms, which always throw her into this condition. This has been so for the last four or five years. Insists she was never afraid of lightning until five years ago, when she was in Providence.

"*Hypnosis.* B II states that she remembers perfectly the first occasion when she was afraid of lightning. It was in the Providence Hospital at night. A tremendous storm came up; there was a great flash of lightning, and she saw a delirious patient running down the corridor towards her; the patient seized her but did not do her any harm. Seeing the patient in the flash gave her a great terror, similar to but worse than the experience of yesterday. Ever since has been afraid of thunderstorms, which excite the foregoing symptoms.<sup>1</sup>

*May 7th and 9th.* "While feeling well, access of symptoms from emotional causes, — disappointment on the one occasion, and fear on the other."

Then again her suggestibility was extraordinary and apparently equally paradoxical, considering the lack of hysterical stigmata of an objective character. It allowed many interesting experiments in anesthesia, negative hallu-

<sup>1</sup> It later transpired, Chapter XIII, that this was not the whole shock, but that on this night she was the victim of a nervous catastrophe which affected her subsequent life.

cinations (or systematized anesthesia) and crystal visions, to be made. It may be of interest if one or two of each sort of these experiments are briefly mentioned. At any rate it will enable those not familiar with suggestibility better to appreciate the condition. All these phenomena were produced by suggestion while Miss Beauchamp was in the waking state. It is easy enough to produce such effects in suitable subjects through suggestion in hypnosis, but no resort was made to hypnosis in these experiments. The suggestions were made to Miss Beauchamp when awake. The following illustrates the production of local anesthesia:

I say to Miss Beauchamp, "Sensation will disappear from the forefinger of your right hand," at the same time stroking the finger with light touches. The finger becomes profoundly anesthetic, so that a pin may be thrust into the skin, and the joints bent without anything being felt. All forms of sensation are included in the anesthesia, which is profound for all objects and stimuli.

In the following experiment the anesthesia is of a somewhat different character:

I hold up a metal rod (an electrode for an electrical machine) before her eyes and say, "Close your eyes for an instant. When you open them this electrode will have disappeared." She closes her eyes and on opening them cannot see the metal rod, though it is held directly before her. She sees my hand, as if holding something, but she sees nothing else. I tell her to feel the rod. She puts her hand upon it and says she can feel it; in fact, she fingers it, and follows the outline of the metal rod and the ball at the top. She feels something that she cannot see. I now say, "I shall pass the electrode from one hand to the other. When it is in the left hand you will see it, but when in the right hand it will disappear." I pass the rod back and forth from one hand to the other, and the moment it is grasped by the left hand it becomes visible, but disappears as soon as seized by the right.

A moment's consideration will show that the anesthesia or failure in perception in this second experiment differs from that in the first in an important respect. The subject is not blind for all objects, but only for a particular object. She sees everything else, everything but a particular system of visual images, the rod. Later, the blindness for this system is conditioned by the relation of the system to the right hand. The rod is not seen when held by the right hand, but is seen when held by the left: the psychological conditions have become more complex, but the systematized nature of the visual anesthesia remains. This anesthesia, aside from the sense involved, plainly differs from that produced in the forefinger. In the latter experiment there was no selection of the perceptions to be included in the anesthesia, but the loss of sensation existed impartially for stimuli coming from whatsoever source.

Anesthesia (whether visual, tactile, auditory, etc.) for particular objects, without loss of perception for objects in general, has been termed *systematized anesthesia* by Binet and Féré, because there is a failure to perceive a particular system of sensory images. This system may include all visual, tactile, and auditory impressions coming from one particular object. Thus, a person may not see a particular individual in a room, while conscious of all others present. In such a case the affected subject may not hear this individual's voice, or feel his touch. He is blind, deaf, and insensible to every impression coming from him, but sees, hears, feels every one else.

Bernheim has given to this condition the name *negative hallucination*, because it is an inability to perceive something that exists, as opposed to positive hallucination which is the perception of something that does not exist.

The phenomenon has been extensively studied, and has been the subject of a great deal of discussion. The com-

mon mode of producing it is to suggest to a person while in hypnosis that he will not perceive such and such objects, persons, etc., after waking; that is to say, it is produced by a post-hypnotic suggestion. Another method devised by Janet is by the principle of abstraction. But Miss Beauchamp was neither hypnotized nor put into a condition of abstraction. She was in her normal waking state, and was the object of suggestion only.

The psychological principle underlying systematized anesthesia has been clearly determined by Janet, Binet, Féré, and others, though many of the details of the process remain to be worked out. The principle is that of dissociation of the personal consciousness. This is the main defect in both local and systematized anesthesia when effected by suggestion. There is not *real* blindness, deafness, etc. The subject does subconsciously see, hear, and feel; but there is a failure of personal perception; that is, the personal ego does not synthesize these sub-conscious sensations with itself. In other words, there is a dissociation and *doubling* of consciousness, the dissociated sensations being parted from the main current of consciousness and left to form a little isolated consciousness of their own. The sensations, however, really arise and are not suppressed. Indeed, paradoxical as it may seem, it is possible to demonstrate by various devices that, for instance, objects for which a subject is blind are really seen in order that he should not see them. For this purpose I may quote some observations of M. Binet:<sup>1</sup>

“From ten cards that were exactly alike I selected one and showed it to the somnambulist, and suggested to her that she would not see it when she awoke, but that she would see and recognize all the others. When she awoke I gave her the ten cards; she took them all, excepting the one that we had shown

<sup>1</sup> “Alterations of Personality.”; translated by Helen Green Baldwin, 1896; pp. 301, 303.

her during the somnambulistic state — the one I had made invisible by suggestion.

“How, we may ask, is it possible for the subject to carry out so complicated a suggestion? How does it come about that he does not confuse the invisible card with the others? It must be that he recognizes it. If he did not recognize it he would not refuse to see it. Whence this apparently paradoxical conclusion — that the subject must recognize the invisible object in order not to see it!

“The necessity for this process of perception, comparison, and recognition may be easily shown, for when the cards are too much alike they are often confused — the more frequently if only a corner of the cards is shown. The subject sees the card so clearly that if the suggestion is given him not to see the particular card on which the word ‘invisible’ is written when he wakes, it may be perfectly carried out, notwithstanding the apparent contradiction that this suggestion contains. . . . But there is more. The invisible object is perceived and recognized. What happens next? Once perception and recognition have occurred we might suppose that the subject then forgets again, that he becomes absolutely blind and deaf, and that his anesthesia is now complete. But this is not at all the case. The perception of the object continues, only it now operates unconsciously.”

Janet succeeded in proving the persistence of subconscious perceptions, and therefore the dissociation of personality, in a more precise way; that is, by making the two consciousnesses reveal themselves simultaneously and exhibit parallel activity. For convenience we will let M. Binet describe Janet’s method:

“The methods employed to demonstrate the second consciousness are various, but the simplest and most direct is that of distraction. I have already said so much on the subject that it is needless to dwell upon it again at length. Only let us remember that the subject’s attention is concentrated upon one thing — for example, by making him chat with another person — and while he is in this state of distraction some one speaks



to him in a low voice, and arranges with him that he shall answer questions in writing. In this way his personality is divided. There is a consciousness that talks with the first questioner, and another consciousness that exchanges ideas with the second. By this method the experimenter may become acquainted with the second consciousness, ascertain its powers, and know in particular how much of the external world it perceives. If this is carried on after the subject has received a suggestion of systematized anesthesia, it may be easily seen whether the forbidden perception has taken place in the second consciousness, and whether the second personality is able to describe an object in minute detail which to the first consciousness, the one that speaks, is quite invisible.

“M. Janet made this observation by applying the suggestion of anesthesia to an object lying in a collection of similar objects. This kind of experiment is most instructive, since it shows better than others how complicated a mechanism systematized anesthesia involves. Here, for example, is a subject in a state of somnambulism to whom five white cards are shown, two of which are marked by a little cross. He is ordered when he awakes no longer to see the cards marked with the cross. Although the subject — that is to say, his principal personality — obeys the suggestion, and on awaking only sees the three white cards, the second personality behaves quite differently. If it is spoken to in a low voice and asked to describe what he is holding, it replies that there are two cards marked with a little cross. The same test may be repeated by substituting for the cross more complicated guiding marks which require calculation to be recognized. For example, one might suggest to the subject not to see the squares of paper that have an even number or a multiple of six upon them, etc. The result of these experiments is exactly the same as in the preceding cases, although the second consciousness cannot take in at a single glance and recognize the card which the other consciousness ought not to see. This proves to us that the second consciousness may perform an action requiring reasoning. Besides, the experiments have been varied in a thousand ways, and very nearly the same result has always been obtained.”

But though the lost perceptions in negative hallucinations are dissociated and subconscious, there is much obscurity regarding the details of the process. Recognition of the object is necessary for dissociation; but who or what first recognizes it? Does the personal consciousness first recognize the marked card? If so, why is the card not seen and remembered by it? Is the marked card first seen subconsciously? If so, then dissociation occurs before perception, though the latter appears to determine the former. The question is an intricate one, and it is unnecessary for us to go into it here. It is probable that we must have a more complete understanding of the mechanism of normal perception before that of systematized anesthesia can be fully understood.

Returning to the experiments with Miss Beauchamp, it was easy to demonstrate that the psychological mechanism of the local and systematized anesthesia was the same as that which has just been described. The only difference was in the device employed to dissociate the sensory impressions. In Janet's experiments the dissociation was effected by a suggestion given in the unstable state of hypnosis; in Miss Beauchamp's case by one given in the waking state. It required only a simple experiment to prove that the pin pricks were really felt, and the metal rod really seen, though not by the personal consciousness of Miss Beauchamp.

To prove this she was hypnotized and changed at once to B II. The hypnotic self, when questioned, was able to tell how many times the finger had been pricked, and whether it had been touched, stroked, or bent. She could also describe, down to the slightest detail, the various performances with the rod, when Miss Beauchamp failed to see it. Inasmuch as the lost sensory impressions were now remembered in hypnosis, they must have been perceived, in spite of the fact that Miss Beauchamp had not

felt or seen the respective stimuli. This means that the perceptions must have remained subconscious,<sup>1</sup> that is, dissociated from the personal perception.

But here another question arises, one to which very little attention has been given, though it is of great importance in solving the problem of the limits of the subconscious, the most important of present psychological problems. What sort of consciousness perceived these subconscious sensations? Or can it be said that any consciousness that can be called a personality perceived them?<sup>2</sup> That is to say, technically speaking, were they perceived at all? Were they not simply isolated, discrete sensory impressions? Though B II remembered them, it could not have been she who perceived them, for this hypnotic self does not persist *as such* after waking. But if B II did not as a personality perceive the sensations how could she remember them?

The problem seems a paradox, but the answer is simple. The psychological conditions present were fundamentally the same as those which exist in hysterical anesthesia. Whatever the process, the suggestion given, *not* to feel the pin pricks and *not* to see the rod, had produced, directly or indirectly, a dissociation, not an inhibition, of consciousness. The sensory impressions from the forefinger were no longer synthesized with (and therefore had become split off from), the personal consciousness, that great group of perceptions and memories which at any given moment makes up the ego or personality. These tactile sensations, then, existed in a dissociated state, and

<sup>1</sup> The point may be raised whether these perceptions could have formed part of the subconsciousness Chris. This is not the place to enter into such questions. The principle of dissociation remains the same whatever the answer. It may be said, however, that subconscious Chris was totally anesthetic for tactile sensations, but could see and hear what Miss Beauchamp was blind and deaf to.

<sup>2</sup> This question will be discussed at length in Part III.

to this extent there was a doubling of consciousness. The systematized blindness for the metal rod was of the same character. On the one hand there was the main personal consciousness, and on the other the concomitant dissociated sensations. Now, when Miss Beauchamp was put into the hypnotic state, itself a condition of dissociation, the memorial images of the previously dissociated pricks of the forefinger became at once synthesized with a personal consciousness, and that consciousness the hypnotic one, B II, which thereby remembered them. It was the same for the visual memories of the metal rod.

This does not mean — contrary to the assumption of many writers — that the hypnotic state persists as a whole or in large part, subconsciously, as a mysterious “hidden self,” after the subject wakes. It seems to me that this has too often been thoughtlessly assumed to be the case. This erroneous assumption has been based on the two fundamental facts that, first, the hypnotic self remembers dissociated perceptions; and second, after waking, by suitable devices (automatic writing, abstraction, etc.) subconscious responses can be obtained from an intelligence which can be identified *in part* with that of the previous hypnotic state. I shall hope, at the proper time, to show that the latter phenomena are largely artifacts.

All that the experimental facts of anesthesia due to dissociation allow us to infer is that the memory of the previously isolated subconscious perceptions becomes synthesized with the personality when the subject is thrown into hypnosis, and (it may be) becomes dissociated again when the subject is awakened. The synthesizing process is the same as when, in hysterical amnesias, lost memories are regained. Here, too, as soon as the synthesis takes place the personality remembers the previously forgotten experiences as its own, as if it had itself experienced them. Thus Fanny S., a subject of mine, is thrown into an hyster-

ical epileptoid crisis by an emotion. In this state the personal consciousness is extremely disintegrated and convulsive phenomena are manifested. On coming out of this crisis she has no memory of what occurred during its continuance. Later, this amnesia is dispelled by suggestion, and she remembers everything that has been said and done; but she remembers everything as her own experience. The same is true of another subject, S. B—w, who similarly remembers the experiences of her epileptoid attack as her own. Likewise in alternating personalities, as we shall see, when the memories of two personalities are amalgamated the resulting personality remembers the lost experiences as its own, as does any one who recovers forgotten memories. So with anesthesia, when in hypnosis the synthesis of the previously dissociated tactile and other sensations with the hypnotic consciousness takes place, the latter remembers them as its own.

The principle of dissociation of the mind is very important. Only by thoroughly grasping it can one understand multiple personality and other phenomena of abnormal psychology. It underlies the great psychosis hysteria, as well as many manifestations of normal life, like absent-mindedness, hypnosis, sleep, dreams, visions, etc. Any extended exposition of the principle must be postponed until the theory of this case is considered, but it is important that the student should be familiar with the data upon which the psycho-physiological law rests.

The mind may be disintegrated in all sorts of ways. It may be divided, subdivided, and still further subdivided. The lines of cleavage may run in all sorts of directions, producing various sorts of combinations of systems of consciousness. All sorts, and many distinct groups of *subconscious* states, each separate from the other, may result. Thus Fanny S. is put into deep hypnosis, a state of dissociation. Memories of experiences forgotten in the

waking state are now recovered. That is, a new combination is formed. The subject is now while in hypnosis still further disintegrated by dissociating, through suggestion, the tactile sensations from the arm. She is told that she cannot feel in this arm, and it becomes anesthetic. The arm is now pricked four times with a pin, and a pencil and coin are placed in the palm of the hand, without the subject's being conscious of what is done. To tap the dissociated sensation, she is now (while still in hypnosis) distracted by being held in conversation by my assistant; at the same time I whisper in her ear that she shall make as many marks with a pencil as the arm was pricked. While conversing, the hand automatically makes *four* marks. The subject is asked to tell verbally what was done to the hand. She interjects automatically aloud in the midst of her conversation, "You put a pencil and a fifty-cent piece in my hand." (Correct.)

This experiment differs from those quoted by M. Binet, in that it was the hypnotic state and not the waking self that was disintegrated and that had the systematized anesthesia.

All these observations represent very simple forms of dissociation, but they prepare us to understand the more complex forms.

It will be well in this connection to point out with more detail the similarity between these forms of artificially induced anesthesia and a pathological condition very frequently the result of accidents, namely *hysterical anesthesia*. The experiments with Miss Beauchamp, I have said, consisted in the production by *artificial* means (suggestion) of the same conditions as underlie hysterical anesthesia. The anesthesia of hysteria is *spontaneous* in the sense that it is brought about by some accident, emotional shock, or other unintentional genetic factor. That this pathological form of anesthesia has the same pathology as the experi-

mentally induced variety has been demonstrated by numerous observers (Janet, Binet, Prince, Sidis, etc.). The following observation by the writer is a good illustration, though now somewhat old:<sup>1</sup>

Mrs. E. B. met with an accident, and as a result had a complete hysterical anesthesia of the hand. The skin could be severely pinched and pricked without any sensation resulting. Under proper precautions, I pricked with a pin "the hand several times, then laid gently upon it a pair of small nippers with flat surfaces (such as are used in microscopical work) and pinched the skin with the same. She did not feel the pricks of the pin, nor did she know that anything had been done to her hand. She was then hypnotized. While in the trance I asked her, 'What did I do to your hand?'

"'You pricked it.'

"'How many times?'

"'A good many times, more than twelve.'

"'Where did I prick it? Show me.'

"Patient indicated correctly with her finger the part that had been pricked.

"'What else did I do?'

"'You laid something on it.'

"'What?'

"'Something long and flat.'

"'What else did I do?'

"'Pinched it.'

"'With what?'

"'Something you had in your hand. I don't know what it is.'

"The patient was then awakened, and the experiment repeated with variations. After being again hypnotized she was asked what had been done.

"'You pricked my hand.'

"'How many times?'

"'Eighteen.'

"'All at once?'

<sup>1</sup> Boston Medical and Surgical Journal, May 15, 1890; Proceedings of the Society for Psychological Research, December, 1898.

“ ‘No; first five times, then thirteen.’

“ ‘What else was done?’

“ ‘You pinched it.’

“ ‘How many times?’

“ ‘Five.’

“ ‘What did I pinch it with?’

“ ‘Your fingers.’

“ ‘These answers were all correct.’”

Such observations, as well as experimental devices which allow the subconscious perceptions to be tapped, show not only that the tactile sensations, unfelt by the hysteric, are really awakened, but that they are dissociated from the personal stream of consciousness; that is, they become subconscious. Equally important is the fact that in certain states of hypnosis the hysteric *spontaneously recovers* the tactile sense in the parts which were previously in the waking state anesthetic. Mrs. R., a subject with hysterical hemianesthesia, equally with Mrs. E. B., when hypnotized feels perfectly in the previously anesthetic areas. Mrs. R., when awake, can feel nothing in her right arm. Hypnotize her, and at once she feels the lightest touch. Anesthesia has completely disappeared in hypnosis. In other words, *the dissociated tactile impressions have become re-synthesized with the personal consciousness in hypnosis.*

Observations of this kind enable us fully to understand that the localized and systematized anesthetics produced by suggestion in Miss Beauchamp were due to dissociation, and were identical with hysterical phenomena. A suggestibility of this degree would necessarily mean instability and lack of resistance to the environment.

*Crystal visions* are perhaps in themselves not indicative of abnormal instability, still the great ease with which they could be induced in Miss Beauchamp could have only this meaning. Considering the part which visions



have played in history, folklore, and necromancy, artificially induced crystal visions acquire considerable interest, for they throw light upon the genesis of such hallucinations. Miss Beauchamp proved to be an excellent subject, and a series of experiments was begun May 24.

It was found possible, by having Miss Beauchamp gaze steadfastly at an object, — a glass bulb being used for this purpose, — to induce visions, which represented, for the most part, scenes in her past life. Some of these past experiences, or details of them, had been completely forgotten. But although forgotten by Miss Beauchamp, every detail was remembered accurately by Chris, who could, in almost every instance, fully explain the vision, and recall every incident connected therewith. A complete study of these visions will be found in Part III, but two of them are given here to illustrate this interesting phenomenon. The details of the composition of these visions are well worth a careful and analytical study.

When Miss Beauchamp looks into a glass globe she does not see the details of her vision as small objects reflected in the glass, but, after a moment or two the globe and her surroundings disappear from her consciousness, and she sees before her a scene in which she herself is present as a spectator. It seems to her that she is a part of the scene in which human beings, — herself, perhaps one of them, — are enacting parts, as in real life. The characters are life-size, and act like living persons. When she sees herself as one of the characters of the vision, she experiences over again all the emotions and feelings that she observes her vision-self experiencing; and these emotions she exhibits, all-forgetful of her surroundings, to the onlooker. This kaleidoscopic play of her feelings is most interesting to watch.

“She appears like one who, at a theatre, is completely absorbed by the play, and in that sense is unconscious of sur-

roundings, but not at all in a trance state. Her absorption and the exceeding mobility and expression of her face give the impression that she is entirely oblivious of all about her, until spoken to, but not as one hypnotized; rather as one who is intensely absorbed in a scene and has forgotten where she is. Every variety of feeling, timidity, surprise, interest, seems to be expressed by the play of her features, and at times, . . . she seems rather frightened by the uncanniness of what she sees."<sup>1</sup>

After each experiment Miss Beauchamp was changed to Chris, whose more complete memory of the past enabled her to give an explanation of many things forgotten by or unknown to Miss Beauchamp. After explaining the third vision Chris volunteered the following story, telling it with great gusto, as a joke on Miss Beauchamp, and speaking with such rapidity that it was difficult to follow the sequence of events. The language as quoted is substantially that of Chris, though condensed.

"She yesterday received a letter from a photographer. She had it in her hand while walking down Washington Street, and then put it into her pocket (side pocket of coat) where She kept her watch and money (banknotes). As She walked along She took out the money and tore it into pieces, thinking it was the letter from the photographer. She threw the money into the street. As She tore up the money, She said to herself, 'I wish they would not write on this bond paper.'"

Chris repeated *verbatim* the words of the photographer's letter, which informed Miss B. that some photographs were ready for delivery. As to the money, there were two ten-dollar notes; this, at my demand, Chris counted mentally, with some difficulty and concentration of thought.

<sup>1</sup> An account of these visions was published in *Brain*, Winter Number, 1898; Part LXXXIV; "An experimental study of Visions," from which I quote with a few slight verbal alterations.

The photographer's letter, Chris said, was in "her" pocket still, and still believed by "Her" to be money. Chris handed it to me. It was folded into a small square, just as one often folds banknotes. *The language of the letter was exactly as Chris had quoted it from memory.*<sup>1</sup> Chris explained further that "She" was absentminded, and thinking of something else, when "She" tore up the money. I gave Chris the letter, which she put back in her pocket, preparatory to my waking Miss Beauchamp. This impish personality gleefully remarked upon what a joke it would be when "She" found the letter there instead of the banknotes. The heartless, cold-blooded delight which this personality found in the loss of the money, — a serious one to Miss Beauchamp, — might be shocking to the uninitiated spectator. To Chris the whole thing was only a splendid practical joke.

Miss Beauchamp was now awakened. When asked whether she did not have some money, and whether she had not received a letter from a photographer, she replied "Yes;" but seemed to think my asking these questions rather odd. A series of questions brought out the replies that she had not the letter with her, having torn it up and thrown it away; and that she had the banknotes in her pocket. They were two ten-dollar notes. When asked to show them to me she put her hand in her pocket and brought out instead the photographer's letter. It was plain that she received a shock, although she tried not to show it. I pressed her to explain where the bills were. After searching in vain she insisted that she must have left them at home. I remarked that she must have destroyed them by mistake instead of the letter, but she refused to admit it, though plainly anxious. I pointed out the circumstantial evidence, but she could not and would not believe it. The loss meant much to her, and she was

<sup>1</sup> On several occasions Chris has exhibited a similar feat of memory.

evidently encouraging herself with a forlorn hope. I then said, taking the glass globe, "We will see whether it is true. Look in and you will see what you have done." At first she saw only indifferent things. Then I said, "Think of banknotes, and the feeling of tearing them up." Now, to her astonishment, she saw herself walking along Washington Street and putting the letter in her pocket; then taking out what looked like banknotes (that is, green pieces of paper), tearing them into pieces, and throwing them into the street. The vision, in all its details, corresponded to the account given by Chris.

The next day Miss Beauchamp reported that she had been unable to find the money at home, and that she was satisfied of the truth of the vision. In hypnosis, Chris now volunteered the further information that Miss Beauchamp ("She") was so much upset by the loss of the money that in the middle of the night "she" had to get up in her sleep, without knowing it, and that "she" had taken the remainder of "her" money and hidden it under "that floppy thing" on the table. It was now "under a red book, a blue book, and that floppy thing" (by this is meant either a tablecloth or a folded piece of material). "She" knows nothing about it, but thinks "she" has lost the money and has none left. Chris does not know how much money there is. Miss Beauchamp is now awakened. I charge her with the loss of the money, the last of her present financial resources. She is reticent, plainly does not like my knowing about her finances, and will not admit the loss. It is clear that she is anxious, for she has discovered that the money is not where she last left it, in the bureau drawer. Without further discussion, and *without disclosing my knowledge*, I presented a glass globe to her telling her to think of the money and she would see what had become of it. Looking into the globe, she saw herself in bed in her room. She then saw

herself get up, her eyes closed, and walk up and down the room; then going to the bureau drawer her vision-self took out the money, went to the table, raised the cloth with the books, put the money on the table and covered it with the cloth, putting the red book and the green book on top of it. The vision thus exactly corresponded to the statement of Chris.<sup>1</sup> Miss Beauchamp reported at the next visit that she had found the money where she saw it in the globe.

The vision of Chris smoking cigarettes has been already given. It is interesting, as the hallucination which wells up into the mind of the primary personality represents an experience of the secondary personality.

The following experiment (5) is of interest for the reason that, first, it represents a delirious act; and, second, that the explanation given by Chris implies that simultaneously with the delirious consciousness there must have existed a second sane consciousness which saw everything as it really was, free from delusion of every kind. I see no other interpretation. Chris's memory showed differences in perceptions, — two different perceptions going on at the same time. The vision represents a previous experience when Miss Beauchamp was delirious from pneumonia.

“Miss B. looked again into the globe; she saw a room with a bed in it. There was a figure in the bed; the figure threw off the bedclothes and got up. Miss B. exclaimed, ‘Why, it is I!’ (Appeared rather frightened at what she saw, but went on to describe it, largely in answer to my promptings, such as, ‘Go on,’ ‘What do you see?’ etc.) She saw herself walking to and fro, up and down the room. Then she climbed on to the window sill which is the deep embrasure of a mansard roof. Then she climbed outside the window and from the sill looked down into the street. It was night — the street lamps were lighted,

<sup>1</sup> Excepting the color of the book, “blue” or “green.” This escaped my attention at the time; perhaps it was blue-green, and looked blue to Chris and green to Miss B., or it may be an error on my part.

there was also the gaslight in the room. As she looked down she felt dizzy. Here Miss B. turned away frightened, saying she felt dizzy as if she were standing there. She soon continued. She saw her vision-self throw into the street below an inkstand, which she had just seen herself pick up before climbing on to the window sill. Miss B. was again obliged to stop looking because of dizziness. After a time she returned to the globe. She saw herself go back into the room and walk up and down; the door opened and she jumped into bed and lay quiet. Miss L. (a friend) entered, went out and returned several times; brought a poultice which she put on Miss B.'s chest; Miss B. herself remaining quiet. Then Miss L. went out and Miss B. got up and took the poultice, rolled it up into a little bunch and hid it in a corner, putting a towel over it. Here the experiment ended.<sup>1</sup>

"Miss B. stated, on being questioned, that she could not remember any incident like the vision, excepting that she recognized the room as the first one she occupied when she came to Boston four or five years ago. It was in the top story of a house on — Street; she was ill there, and Miss L. took care of her. But she did not remember ever having climbed on to the window, or having thrown an inkstand, or any of the incidents of the vision. She could throw no light on the affair.

"*Deep hypnosis*: B III appeared. With great vivacity and amusement B III explained the whole scene. 'She' had pneumonia and was delirious; and 'She' imagined 'She' was on the seashore and was walking up and down the sand. This was why 'She' walked up and down the room, and 'She' stuck her toes in the carpet thinking it was the sand. There were rocks there, and the window sill was one of them, and when 'She' climbed out upon the window sill 'She' thought 'She' was climbing upon a rock, and 'She' took up a stone, as 'She' thought, and threw it into the sea. This was the inkstand that 'She' threw into the street. Then when 'She' took the poultice and hid it in the corner 'She' thought 'She' had buried it in the sand. Ink had been found in her shoes, but 'She' had

<sup>1</sup> Miss L., a physician, has confirmed her own part in this scene and the general facts of the illness as she knew them. Another physician had diagnosed pneumonia.

not poured ink into her shoes, but her hand shook and 'She' had spilled it into her shoes. Miss L. seeing the inkstains had inferred that Miss B. had poured the ink into the shoes, and had told Miss B. so. B III was highly amused at all the mistakes of Miss B.'s delirium."

I may point out here that visions belong to the class of phenomena known as sensory automatisms. Considerable difference of opinion exists regarding their genesis, which is unquestionably complex, but they are automatic in that while they arise within the field of the personal consciousness, they come and go entirely independently of personal control. It can be experimentally demonstrated that in many instances their exciting causes may be in forgotten memories and subconscious ideas, which also determine the content of the visions. Aside from the question of suggestibility, some of these experiments, of which quite a number were made, are very instructive from two other points of view, namely: in showing first, the distinctiveness of the two coexistent conscious selves, as far at least as concerns the separateness of the simultaneous perceptions; and, second, the greater completeness of the memories of *Chris for a certain class of facts*.

This last point, which I have italicized, I am disposed to dwell upon here even at the expense of interrupting my narrative, as there is danger of erroneously inferring that because a person in hypnosis or a secondary self of any kind, remembers more completely and fully certain details of the past, recalls facts and even lost knowledge, like the rudiments of a forgotten language acquired in childhood, that therefore the hypnotic self has a wider memory in all respects, and is a superior intelligence. There is a certain class of facts which a person in hypnosis remembers more completely than does the waking self; but these facts, for the most part, are the details of every-day life, which, unimportant in themselves, the waking self neglects to

observe and remember, because occupied at the time in profounder thought, in more important reflections which necessarily require comparatively abstract ideas. The child mind occupies itself with such details, but the adult mind neglects them. The child mind, probably, like the mind of animals, is occupied with the observation of details; if observing a man, for instance, it notes every detail of his appearance and movements. The adult mind makes an abstraction (relatively speaking) of any given man, and weaves this abstraction into a mass of thoughts. If this were not so, intellectual accomplishment would be impossible for the adult.

But with the adult the minor details of life are not entirely neglected. They are more or less observed and recorded in an absent-minded sort of way, and as isolated perceptions, form what is known as the normal secondary consciousness; that is, they are subconsciously perceived. (*Part III.*) In hypnosis the memories of this secondary consciousness are synthesized with the hypnotic self and are remembered by it. In this respect a person in hypnosis may have a more complete memory than when awake. Then again, in hypnosis, certain acquisitions, like a forgotten language, may be more or less remembered, and hundreds of forgotten experiences of the past — forgotten by the waking self — may become synthesized with the hypnotic self and be recalled, just as forgotten experiences are reproduced in dreams. But the accumulated stores of learning, the laborious product of burning the midnight oil, the expert knowledge of the linguist, of the scientist, the physician, the lawyer, as well as the wisdom drawn from the past experiences of the ordinary man, — the memory for all this is not spontaneously revived and made use of by the so-called hypnotic self<sup>1</sup> as it is by the unmutilated con-

<sup>1</sup> The term "hypnotic self" is only a convenient expression for a *hypnotized person*, or a *person in hypnosis*. There is no special hypnotic self.



sciousness of the normal waking person. Above all, the accumulated knowledge of the past is not at the command of the hypnotic self for deliberate judgment, for the determination of conduct, and the expression of the will. Hence, largely, the passiveness of the hypnotic mind. To maintain the contrary is to maintain in principle that a dissociated mind is as good as a normal one. But to return to our visions:

Miss Beauchamp occasionally had spontaneous visions, similar to those experimentally induced. These played an important part in her career. Sometimes a vision seen by one personality represented scenes enacted by another (and therefore unknown to the former), as in the vision of Chris smoking the cigarettes. Sometimes visions were intentionally induced by me for the purpose of acquiring information about obscure events, and sometimes one of the personalities (excepting Chris, who could see nothing, as she complained) would make use of the same device for the same purpose. These phenomena, so far as I feel at liberty to use them, will be described in the course of this narrative.

The following incident, which occurred May 18, illustrates what has been said about the ease with which sensory impressions revived within her emotions and ideas that had become associated by some event of the past. It has been stated in the introduction that Miss Beauchamp had been in the habit from time to time of going into somnambulistic or trance-like states lasting a few moments. This was first learned about this time when she reported that while crossing the Public Gardens, headed for Park Square, an attack of this kind came on; when she came to herself she found that she was in a different part of the Gardens, and walking in an opposite direction.

On the night of the eighteenth, being at the time in

good physical health, while brushing her hair preparatory to going to bed, Miss Beauchamp fell into a trance. When she awoke she found herself sitting in a chair. The clock was striking nine when she went into the trance, and it was half-past nine when she awoke. It seemed certain that the cause of this trance state must have been psychological; something like subconscious ideas, or, if not, at least certain remembrances of past events, connected perhaps with a previous nervous shock, and now awakened by an association of some sort. Investigation revealed the following: Just before going into the trance she found herself thinking of an old girl friend. How she came to be thinking of this friend she did not know, but this girl once gave her a severe nervous shock, and she has noticed that the occasion of going into trances of late years almost always has been while thinking of this girl, or while hearing certain music, or the sound of the wind, or while feeling the air blowing on her face, and other sensations, all of which are associated with this friend.

It came about originally in this way: A long time ago, while in church and while the organist was playing the Hallelujah Chorus from Händel's Oratorio, this friend leaned toward her and told her something that gave her a severe shock, — much as if she had told her the news of some one's death. At the time she smelled the odor of incense in the church, heard the wind blowing through the open window, and felt it on her face. All this she was distinctly conscious of at the time, as well as of the nervous shock. Then she remembered nothing more for a few minutes. Now anything that recalls this girl, or the scene in church to her mind, — such as the Hallelujah Chorus, the smell of incense, the sound of the wind, or the wind blowing on her face, — is apt to send her into a trance. But, as has just been said, what made her think of the girl on this occasion she does not remember. What

Miss Beauchamp was told in church concerned an old friend, one of whom we shall hear more, and whom we have agreed to call "William Jones." This person, unintentionally, and perhaps all unconsciously, — who shall say? — has played an important part in the pathological drama of Miss Beauchamp's life. In the frequent hunts for the hysterogenic influences which induced the various hysterical accidents, it too often happened that the exciting cause was found, as in this incident, to be past and present associations which acquired in her mind an intensity characteristic of hysteria.

After recounting this experience, Miss Beauchamp was hypnotized. B II then supplied the missing link in the chain of events. The window was open while Miss Beauchamp was brushing her hair, and the air blew upon her face just as it had done long before in church. The *feeling of the air* recalled the girl and the scene in church; then she went into a trance just as she had when she received the shock. In quest of further evidence I brought Chris, who in turn corroborated, in her own contemptuous way, all that the other two had said.

"What were you doing at the time?" I asked.

"What was I doing? I was n't doing anything. She was brushing her hair. She was thinking about school, when the wind began to blow outdoors. I, too, heard it and felt it. The window was open; the air blew on her face, and then she began thinking of church; and the music, the Hallelujah Chorus, came; and she went off to sleep, and she looked very silly, and she settled down so [illustrating contemptuously]."

Chris also corroborated everything that Miss Beauchamp had said in her narrative of the original episode, stating that whenever either Miss Beauchamp or herself heard that peculiar sound of the wind, the scene in church came back to them, no matter where they might be. Chris was

reminded of it by the sound, as well as Miss Beauchamp. "“She’ heard the music, and I heard it, too,” Chris explained. “When ‘she’ heard it last night ‘she’ saw the whole thing over again, and ‘she’ wanted to sit down and cry, but ‘she’ would n’t. ‘She’ just sat in the chair and looked like a fool. ‘She’ sat down, and dropped back, and did so — [illustrates position]. ‘Her’ eyes were not shut.”

“What were you doing?”

“I was meditating.”

“What about?”

“How silly ‘she’ looked.”

Chris could not say what her other self’s psychical state was while in the trance, excepting that she denied it was herself (Chris). Later investigations seemed to show that at such times it was neither of the other selves; that is to say, the spontaneous somnambulistic condition is a state by itself.

As will appear in the course of this biography, a suggestibility of the degree indicated by these observations would necessarily also mean so great an instability and lack of resistance to the environment that ideas, feelings, and emotions would acquire such a degree of fixity and intensity that they would tend from moment to moment to dominate a person’s life. Therefore Miss Beauchamp, like many other people with the hysterical temperament, would tend to become the slave of her own mind. That instability and suggestibility should persist, no matter how well she might be physically, was difficult to understand; for during all this time there was no reason to suspect that Miss Beauchamp was not what might be called, without using particularly figurative language, a real person; a complete and normal personality, excepting so far as she was affected by physical infirmities. It was not until a year later that the secret leaked out.

## CHAPTER VI

### HOW SALLY GOT HER EYES OPEN AND THE SUBCONSCIOUS BECAME AN ALTERNATING PERSONALITY

MISS BEAUCHAMP'S life at this time was a quiet one. She had left college to come to Boston for medical treatment; and when not in the consulting room, where many hours a week were occupied, she passed her time between her books, her friends, and pursuing a hygienic régime. It must be borne in mind that as yet she had no knowledge whatsoever of the existence of any second self, or of any consciousness beyond her own waking one. Everything she said and did as B II, and as Chris, was kept strictly from her. Her knowledge was limited to the fact that she went to sleep by command and waked up again. She was therefore in complete ignorance of her subconscious mental life, and of the fact that there was reason to suspect that there were within her trains of thought entirely out of harmony with her waking consciousness.

It will be remembered that both B II and Chris used to try to rub their closed eyelids with the hands, though, as far as possible, I prevented both from doing this, often using physical force. B II never could explain why she did it; but Chris, speaking for herself, always said up and down from the first that it was her deliberate purpose to get her eyes open, and even went so far as to threaten insubordination, insisting that she *would* see, and that she "had a right to see." She complained rather piteously that it was not fair Miss Beauchamp should be allowed to see, while she was forbidden.

So sometimes when B II rubbed her eyelids, as Chris later confessed, it was not B II herself who did it but Chris, "inside," as it were, who took B II's hands and rubbed her eyes. At such times Chris thought that if her eyes were opened (the joint eyes of B II and herself), she (Chris) would be able to see, and thereby would awake in the place of B II. It was not surprising, then, that at such times B II did not know why she rubbed her eyes, for it was another self, Chris, who was doing it. That all this is true there can be no doubt; especially as it was noted at a later period that whenever Chris wanted "to come" while Miss Beauchamp was in hypnosis, the hands used to rub the closed eyelids (the eyelids of B II), and, unless forcibly prevented, the eyes would open and Chris would appear upon the scene. As the meaning of this device to get the eyes open early became manifest, neither B II nor Chris, as has already been stated, was permitted to make use of it. I felt it to be unwise that either of these selves, and particularly Chris, should be allowed to form independent groups of mental experiences and thereby chains of memories, thinking that if such should take place either self might become educated into an independent personality. Inasmuch as our visual perceptions form the largest and perhaps the most important part of our sensory experiences, it seemed probable that the possession of the visual apparatus would tend to enable the second personality to acquire a large degree of independence. Neither B II nor any of the hypnotic states proper has ever been allowed to open the eyes in hypnosis, to the present day. As to Chris, such a precaution was felt to be particularly important, for as long as her eyes were kept closed, her independent activity would be limited and she could be kept under control. It was also sought to confine her hypnotic experiences within the narrowest limits compatible with therapeutic ends. All attempts, however, to limit the mental

experiences of Chris were hopeless. She proved herself made of different stuff, and, as it transpired, had an existence which, if her own story is to be believed, long antedated her first appearance in my presence.

To explain still further this device for getting the eyes open, it may be stated here, although it is anticipating somewhat, that, according to the testimony of Chris, the mechanical device of itself alone was without effect. Besides rubbing her eyes she was obliged to "will" to come. "Willing," as a part of her conscious processes, plays a very prominent part in the psychological phenomena manifested by this personality, particularly in those which are the effect of her influence upon the others.

"How did you make her do this or that?" I frequently asked.

"I just 'willed,'" was the reply.

In passing I may also call attention to the value of the information which Chris as a subconscious personality was able to give concerning many phenomena which otherwise would have been inexplicable, or, apparently, insignificant. Such information, of course, rests largely, as in the instance of willing, upon the statement of Chris, and is not open to objective verification, as must often be the case when we have to do with subjective phenomena. But I believe that the statements of Miss Beauchamp and Chris, as far as they concern facts of which they have knowledge, — such, for example, as their own acts or thoughts and feelings, — are as reliable as any statement based on personal experience or introspective knowledge can be. Some of the statements of this sort could to a certain extent be verified. Over and over again, at a later period, I have seen B II while conversing, her face expressive of sadness and weariness, rub her eyelids in an unaccountable way, until of a sudden, Chris, laughing and gay, would burst out of her chrysalis into her butterfly existence. The

one phenomenon would follow the other so regularly that it is dull scepticism to disbelieve the assertions of Chris that it was she who rubbed Miss Beauchamp's eyelids and "willed" to come. As has just been said, B II did not know at such times why she rubbed her eyes; she felt herself impelled to do it. Her actions, then, being accomplished by another consciousness, were further examples of subconscious automatic movements.

At other times Chris would disclaim all responsibility for the act, saying that it was B II herself who did it, and that she, Chris, did not know the reason for it. The explanation was found in the fact that at such times B II complained that her eyes "stung" and "burned," and she felt that she must rub them to relieve the sensation, which was intense. This sensation, it was discovered, was due to the effect of "willing" by Chris. Although she did not make use of B II's hands, yet at such times she "willed" the eyelids to open. This sensory phenomenon is an association phenomenon, or what is known as *akinesia algera*, — the association of pain with voluntary movements. It is probably similar to what is observed in eye-strain, when, as a result of strong muscular effort to use the eyes, one or another form of paresthesia is experienced. At such times B II was simply trying to relieve the disagreeable feelings caused by Chris's "willing" to control the muscles of the eyelids.

I dwell upon these facts, longer than would seem to be called for, at the risk of tiring the reader, for two reasons: first, because, as will presently appear, they play an important part in the development of the case and enable us to understand how Chris finally succeeded in getting her liberty; and, second, because from one point of view they are of great significance, namely, as evidence of the *coexistence* of two separate and distinct consciousnesses. If it be true, while Miss Beauchamp or B II is



conversing on one subject, some other consciousness is using the hands and "willing" something entirely outside the field of consciousness of the first, and unknown to the first, there must be two distinct, separate, and coexisting trains of thought.

To return to our story: Miss Beauchamp, in June, had gotten into a nervous condition again, owing to various outside matters which disturbed her. Without going into these in detail, it is sufficient to say that, among other troubles, she brooded over the fact that she was not allowed to go back to college, and that certain emotions of the past had been revived. A certain episode which had recently occurred (as was afterwards learned) had brought back the recollections and associations of a painful event which had once given her a profound shock. This and other things threw her again into a nervous condition, accompanied by insomnia. All this was hard on Miss Beauchamp, but the conditions were propitious for Chris.

One day toward the end of June Miss Beauchamp was sitting by the open window reading. She fell into what Chris afterward called a half "mooning" state. She would read a bit, then look out of the window and think; then turn to her book and again read. Thus she would alternately read and dream,—day-dreaming, it was. All her life she had been in the habit of falling into these states of abstraction (for such they were), when she lived in the clouds. Here was Chris's opportunity. The physical and mental conditions were ripe. Chris was not one to let such a golden chance slip by. So while Miss Beauchamp was dreaming in her chair, Chris took both her hands,—Miss Beauchamp's hands,—rubbed her eyes, and "willed"; then, for the moment, Miss Beauchamp disappeared and "Sally" came, mistress of herself, and, for the first time, able to see. From this time on, we shall call Chris by the

name of Sally; for though it was much later that Chris took the name, the complete independent existence of this personality dates from this event.

Sally had gotten her eyes open at last, and with the opening of her eyes she may be said to have been truly born into this world, though she claimed to have really existed before. Sally was delighted with her success, so she must celebrate her birthday by smoking two cigarettes.<sup>1</sup> Her belief in the naughtiness of it all, and a consciousness of the displeasure which it would occasion Miss Beauchamp, added to her enjoyment. But her delight did not last long. She became frightened. The thought came to her that perhaps Miss Beauchamp might be "dead," and would never come back; perhaps she could not bring her back. What would she do then! She became alarmed at the thought. She knew that she did not know how to wake up Miss Beauchamp, and, as she realized her inability, her fright increased and she did not want to stay. An idea came to her. She remembered that sometimes I used to employ a strong Faradic battery to wake Miss Beauchamp when she (Chris) would not go at command.<sup>2</sup> So Sally took the lighted cigarette, burned her arm sharply, and Miss Beauchamp woke up.

The following letter (A), unfinished, written by Sally to me, as well as the second (B), written to "William Jones," gives a better glimpse into her mind. The first is a triumphant Hallelujah, for at last she had gotten her eyes open. This was written immediately after the event. The second is of later date, probably some time in the next week.

## (A)

"MY DEAR DR. PRINCE, — Rejoice with me and be exceedingly glad, for I am on the top of the heap at last! Never again

<sup>1</sup> Previously given her by me.

<sup>2</sup> This probably acted by awakening the lost tactile feelings belonging to B I and which Sally did not possess (Chap. IX).

shall I be squeezed<sup>1</sup> — never again be bored! Ah, how good it is! and you — unkind — refused it to me. Hereafter I know you not — you shall be as ”

## (B)

[To W. J.] “To-morrow, mio caro amico, we go to the shore for the day. Please stop at P. & S.’s<sup>2</sup> first and then meet me at the Union Station at ten.

“As always,”

Miss Beauchamp had captured these letters and sent them to me. If one compares them with the following extracts from her own letter, in which they were enclosed, the difference in personalities is strikingly shown :

“DEAR DR. PRINCE, — I do really think that, like those poor people of old, I must be possessed of devils. . . .

All this is to explain my sending you the enclosed notes. . . . To-day my sin consisted in telling but half the truth, as you will see by looking at the notes, one of which [(A)] is very absurd, and wholly without meaning, as I told you. The other [(B)], as I did not tell you, is apparently a perfectly natural note. But it is not natural or like me at all. I do wish you would believe me, Dr. Prince. I know you won’t. It is not because the note is wicked that I disclaim it. . . . You must know that, from what I have told you of my life. I want you to believe me, because I am frightened, and afraid of myself if such things are liable to occur at any time. I *know* that these two last attacks are different from any I have ever had. It is as though I were filled with the spirit of mischief incarnate. . . .

“And now, hoping most sincerely that you will forgive me, and won’t be very cross because I have troubled you with this appeal, I remain, etc.”

<sup>1</sup> This was a term invented by Sally to describe a peculiar psychical state of some importance. In this state she lost the power to influence Miss B. or to “come” herself. She used to say she felt “squeezed.” I never could get any more precise explanation of her mental condition.

<sup>2</sup> A confectioner.

During the next ten days or so Sally used to come and go, more or less, but she could not always do it when she wanted to. It depended largely upon Miss Beauchamp's condition of health, and particularly upon a condition of fatigue which was necessary. The better Miss Beauchamp's health, the more deeply and strongly was Sally imprisoned, — "squeezed," to use her expression.

Things soon came to a climax. On Thursday, June 23, Miss Beauchamp, in a condition of some alarm, telephoned that she had lost ten hours after leaving my office the preceding afternoon. When she came to herself she found in her hand a lighted cigarette which had burned her finger, and, apparently, waked her up. Her dress and clothing were dusty, as if she had returned from a walk in the country. She was tired and worn out. The next day, Friday, she reported that not only had she again gone into a trance, but that she had also lost some money in an unaccountable way. On the following morning I received this note, in which the hand of Sally was unmistakable :

"DEAR DR. PRINCE, — I wish you would not be so awfully wrathful and superior — it spoils half my fun — and Jones's anger, if it were not too amusing, would quite spoil the other half. It is unkind of you to desert me, and to refuse to uphold the new order of things. You reduce me to one small victim, who is both tiresome and absurd. *Please be amiable*, and you shall have half the P. & S. — which is an abbreviation for something very nice indeed. Also I will tell you many things good for you to know and useful, but not here, for you say 'dam' (I have heard you, my child) both to notes and telephone. So I make this most brief, that you may favorably hear my petition. Miss Beauchamp does not go to Winchester to-night<sup>1</sup> — she is much more useful here and infinitely more entertaining. I shall take her walking again presently. It is so good for her, don't you think so? And she goes very fast for me.

"Please be nice, and believe me,

"Your obdt. servt.,"

<sup>1</sup> She had an engagement to pay a visit to a friend in Winchester.

Hastening to visit her, I found Miss Beauchamp in her room in a wretched condition of extreme fatigue, going easily and spontaneously from time to time into a trance. She could not remember anything about her whereabouts since her visit to my office the preceding afternoon, or where she had passed the night, although from the testimony of the servant she had been at home. Presently going into one of the spontaneous trances she became Sally, who now gave a full explanation of her doings. Sally had been at home, but had gone the day before to the confectioner's (P. & S.'s) and bought a box of candy, spending about two dollars (the empty box was on the floor); then she had had a royal lunch out of Miss Beauchamp's exchequer, but had had the mishap to lose quite a sum of money by its being blown away while she was on an electric street-car.

After administering a judicious lecture to Sally, with suggestions, Miss Beauchamp was awakened, apparently in good condition, so much so that she refused to go to the hospital; but in the evening a messenger brought a note in which was hastily scrawled the following:

“Please let me go to the hospital, and at once. I am awfully frightened.”

On the way to the hospital she kept relapsing into trance states, the exact character of which it was not easy to determine. Her stay in the hospital, where she came under the care of Dr. Y., lasted about ten days. There an amusing thing happened. It was reported to me that Miss Beauchamp was recovering rapidly and was free from insomnia. Feeling pleased with the rapid improvement under my brother practitioner's charge, I hastened to make her a visit. As I walked into the room I was astonished to see not Miss Beauchamp, but Sally, stuttering and merry as a grig, and having a delightful time impersonating her other

self. It came to light that Sally had conceived the idea that as she herself was free from ailments, if she could impersonate Miss Beauchamp she would be considered well, and so escape from the hospital and go to Europe, as had been previously planned. So, when the night nurse looked in upon her, Sally was always found "asleep"; the day nurse had an equally good report to make, and Miss Beauchamp was soon, in spite of my warnings, discharged "well." A few days after this I caught Sally just in time, on the verge of her departure for Europe, and changed her, against her will,<sup>1</sup> to Miss Beauchamp, who was astounded

<sup>1</sup> The scene which took place on this occasion illustrates very well Sally's attitude towards the world in general and towards her superior self. Though I recognized her at once, she pretended to be Miss Beauchamp, copying her air, her mode of speech, and mood. But finally when appealed to for her confidence she confessed all, saying that she did not want to be in her normal state; she enjoyed life much more as she was; she wanted to go to Europe and have a good time; and she positively refused to let Miss Beauchamp be awakened. Arguments, expostulations, even threats were of no avail. She did not want to be the other one, of whom she spoke in contempt. She simply defied me to wake Miss Beauchamp, and in fact every attempt on my part was unsuccessful. Finally we compromised: she agreed to allow Miss Beauchamp to be awakened, and I, on my part, agreed (may the ruse be pardoned!) that Sally should come again when Miss Beauchamp was *well*. She then explained that verbal suggestion was not sufficient: I must imitate the cigarette burning to awaken her. Taking the hint, a strong electric battery was employed to do the work, and Miss Beauchamp awoke, frightened at finding herself where she was.

The following letter, written while in the hospital, is interesting psychologically; it shows that Sally could, at times at least, realize responsibilities and had a certain fulness of character. I had threatened Sally that if she did not behave, did not cease writing to Jones, etc., etc., I should report her conduct to Mrs. X. This brought from Sally the following letter:

"DEAR DR. PRINCE, — You simply must not spring Mrs. X. on me now, for I too care for her more than for all else. Indeed you must not. I will promise you anything, and I have kept my promises. I would take the most solemn oath that that is true. I have never broken but one, and although that one seems to affect you more than any other I did it only because you first broke yours, and because I wanted to see if it were possible for me to do certain things. I can do them, but alas, I cannot undo them. I think you can. I am sure you can if I do not oppose you. Don't misunderstand me and think that I am sorry or ashamed: I am neither, but always I have worshipped Mrs. X., and it is for her. *Don't* speak to her until you have straightened this out. These people can never do it. They are content if I

to find herself in my office, her last recollection being her entrance into the hospital ten days previously.

It was thus by a lucky chance that Sally did not go to Europe instead of Miss Beauchamp. The latter left Boston the next day for Europe, and aside from a few exceptional hours remained herself during the rest of the summer.

am quiet and sleep, and you know I am strong-willed enough even for that — if it be necessary. Do consider this seriously. I can be *serious*, whether you believe it or not."

## CHAPTER VII

### SALLY "ON TOP OF THE HEAP"

**I**N the fall Miss Beauchamp returned from Europe. She was much improved in health, being practically free from the distressing symptoms which for several years had made life almost unendurable. As far as physical well-being was concerned, life had become fairly enjoyable. If she had been more stable, or had not been exposed to constantly repeated, even if mild, nervous shocks, to which her impressionable temperament contributed, there would have been little of which to complain. But this instability, and her unfortunate emotional make-up, together with one particular disturbing factor of her environment, were destined to bring about new mental troubles, which, though highly interesting and at times dramatic from a psychological point of view, were very hard for her to bear. In short, her comparative health soon came to an untimely end.

In the latter part of September Miss Beauchamp reported that she had had a number of attacks of somnambulism of a very curious sort. During the summer abroad she had had several such attacks, each of several hours' duration. She would go into them spontaneously; usually, but not necessarily, as a consequence of fatigue. If this were all there would have been nothing remarkable about them, as it will be remembered that she had been subject to attacks of somnambulism during much of her life, and had had several attacks in June. To her, the curious part of it now was that in these attacks she played tricks, not on other people but with the evident desire of tormenting herself. Miss



Beauchamp was very much discouraged by this new phase of her infirmity, as the results were extremely annoying and often embarrassing. She felt mortified, too, that she should indulge in such tomfooleries, even though it was done in a trance. The following extract from my notebook gives an idea of the general condition of affairs:

*October 28, 1898.* "Miss Beauchamp to-day is very much distressed over her doings in these trances. In such states the desire shown to torment herself is most absurd. She writes to herself letters which she finds on awaking in the morning. In these communications she indulges in personal abuse of herself, criticising her own actions, and calling herself names. The information which she received in this way, together with that contained in letters written to W— J— are her principal sources of knowledge of what she does in the trance state, and even of the fact of having gone into one. J——is not aware that the letters to him are written in a trance, and she herself learns of her own letters only through him. In style, these trance letters are not at all like those of her normal self. In her last trance she tore up four or five pages of mathematical work which had been accomplished after many hours of labor as a part of her college exercises.<sup>1</sup> This is only a sample of what she does. In one attack she took a long walk into the country, and in another made a call on Mrs. X. [Mrs. X. later reported that she noticed nothing unusual about Miss Beauchamp during this call, except that she stuttered.] Miss Beauchamp herself learned of the visit and of her behavior at the time only through one of the letters written to herself."

Besides being the victim of trances, Miss Beauchamp complained that she was "tormented" by some other very curious phenomena in the waking state, similar to the impulsive lying previously noted.

[From notebook.] "She often feels an irresistible impulse, as if possessed by something inside of her, to do and say things which she has no desire to do and say. For instance, a day or

<sup>1</sup> She had begun to take a course in a college in Boston.

two ago, she found the greatest difficulty in coming to see me because she felt something trying to prevent her; though she succeeded in coming to the house, yet after awaiting my arrival some little time she found it impossible to wait longer; something inside of her made her nervous and forced her to go away in spite of herself. There is something, she feels, that is trying to prevent her seeing me. To-day, while in the waiting-room, she felt an impulse, devoid of desire but difficult to resist, to lock me in my office. [To conceive of Miss B.'s committing a breach of propriety like this is to imagine the sister superior of a convent dancing a can-can.] It also troubles her that she makes remarks of an impertinent character to Miss K."

It is difficult to give accurately Miss Beauchamp's keen analysis and detailed description of these uncontrollable impulses. That she was disturbed by such mental aberrations goes without saying. Not to know what one will do next, what false position one will awake to find oneself placed in, or what responsibility unconsciously assumed, would be trying to the most reckless character; and if we imagine an over-conscientious nature, with a strong sense of responsibility, finding herself compelled to do and say what is repellant to her instincts, we can understand the sense of hopeless tangle into which she seemed to be getting.

Though Miss Beauchamp, who, it will be remembered, was still ignorant of Sally as a personality, naturally sought an explanation of these phenomena, it did not seem wise that she should be enlightened. Aside from the possible ill effect of such knowledge upon her nervous system, I was deterred also by the possibility that the accuracy of her observations of herself might be disadvantageously affected if she should have any psychological theories in mind; and as long as ignorance could do no harm it was desirable that her knowledge should not extend beyond the observations of her own actual experiences.

My first suspicion, amounting, of course, almost to a moral certainty, was that it was Sally who was at the bottom of all this mischief. It was most probable that when Miss Beauchamp went into a trance she changed to Sally, who, being now independent, played these pranks and followed her own bent. It must have been Sally also, who, as a hidden self, made her, when awake, do things against her will. Miss Beauchamp had laid great stress on the difficulty she had had in coming to see me, and in staying after her arrival, having been hindered by this something inside of her. I knew that Sally objected to Miss Beauchamp's being helped; indeed she had every reason for keeping out of my way. It was most probable, therefore, that it was Sally, as a second consciousness, who caused the irresistible impulses in Miss B. But of course this theory remained to be proved. And, if true, there still remained the psychological problem, What kind of personality is Sally? I mean what relation did she bear to the normal consciousness? One or two hypotheses had already forced themselves forward, — but all this will be discussed later in its appropriate place.

The next day any doubt<sup>1</sup> about the correctness of my surmise was set at rest by the receipt of the following letter:

"MY DEAR DR. PRINCE, — You are most absurd and idiotic to waste your time and sympathy on such a perfect chump as our friend is. I do not like it at all, and I won't have you doing it. And moreover I won't have you trying hypnotism again on any account. Do you understand? We do not need it, and we won't have it, and we are not interesting psychology [sic]. You make me so angry talking a lot of absurd nonsense that you know is n't one bit true. Goose! Why won't you be reasonable? Our friend is going to weep salt tears when she knows I have

<sup>1</sup> Assuming, of course, the following letter authentic, about which subsequent events allow no room for doubt.

written you. Won't it be jolly? and serve her quite right too, for she thinks altogether too much of 'dear Dr. Prince' and too little of my long-suffering Jones. She needs discipline and my tender care. I know her a great deal better than you do, and I know she is really awfully wicked. Do believe what I tell you. . . . I want you to very much — and you know you are awfully busy with people now. Please be good and let me alone. Don't heed her foolish appeals — she is a perfect baby. Even Jones says, and he is clever too, that she has absolutely no comprehension of things. He gets so cross. You may have those notes, if you want them. They are very nice ones too. Much better than hers."

Even if the contents of this letter had not shown the mind of a different personality, the tone was so unlike Miss Beauchamp's that it would have been impossible to attribute it to her. The handwriting alone was hers. Some of the expressions refer to remarks I had made to Miss Beauchamp, such as that her case was very interesting "psychology" [psychologically] (Sally meant to use the adjective, but always found it too much either to pronounce or write), and my request for the notes which had been written to herself in trances. The possession of this knowledge by the writer showed that she was familiar with what had occurred between Miss Beauchamp and myself during the interview of the preceding day, and therefore had no amnesia for this time; and if the writer was a subconscious personality it looked very much as if she must have been consciously awake at the time and heard the conversation. A comparison of the tone of this note with that of the following two letters, written at this same time, is interesting. These latter, written by Miss Beauchamp herself, give an idea of her point of view and general attitude of mind.

"DEAR DR. PRINCE, — I am so anxious to see you and talk with you a little — if you are not utterly exasperated with me.

And I do want you, *please, please*, to hypnotize me again. You know it is the only thing that has ever helped me, and I am sure it is the only way, save by fasting and vigil — which you know I am not up to — to cast out this demon of mischief, which rules me as it will. The last two attacks have not come because of sleeplessness, or pain, or because of any of those reasons you suggested for my consolation, — and really, Dr. Prince, I cannot believe you, much as I should like to, when you say that it is a common thing for people to be afflicted in this way. You have been wonderfully good about it all, but I realize perfectly what you must think, knowing me as well as you do. And I know that you do not believe that the rest of the world is just as bad. If you are to be at the office again soon, will you send me a note? I was so sorry not to see you yesterday, — and I am afraid that you won't understand if I say that much as I wanted to see you I could not stay [i. e., in my office]. Has Dr. Y. told you that I went to him while you were away because I was in such terror of another attack?"

"DEAR DR. PRINCE, — I hope you will forgive me for troubling you again so soon. I would not except that I need advice so very much, and no one else understands. It is all that horrible, incomprehensible freakishness, — or whatever you choose to call it, — which seems to take possession of me at its own sweet will. You know it has troubled me more or less all this autumn, and because of it I have tried to keep away from people just as much as possible, and have especially avoided Mrs. X., for I feared greatly that seeing her might bring on one of those attacks when I seem to be possessed of forty devils. Please don't be amused. I am in despair when I think of it all, for yesterday, while I was still possessed, I went to see her, and although I have reason to believe that I did nothing worse than to stutter,<sup>1</sup> yet I cannot be sure. I do know or believe that I was very much frightened on seeing Mr. X. appear, and that the only thing I said was to beg him not to tell Dr. Prince that I stuttered. Is n't it too dreadful! and what can I do? Shall I try to explain to Mrs. X., or will that only make matters worse? I am a sure-enough prodigal — there is no doubt of that —

<sup>1</sup> See notebook record, October 28.

but I think it is rather hard lines to lose one's head so literally as I do. You have been awfully good about it all, but I beg you won't desert me yet. No one would ever believe in such an impossible affliction, I am sure. It is such an unheard-of thing. I can hardly believe myself that it is true, — my doing all those things which ordinarily I have the greatest contempt for. Perhaps it is a case for fasting and vigil. Sometimes it seems as if it must be. If you will send me just a word saying whether it would be better to try to explain to Mrs. X., I will be most grateful to you."

Sally was evidently afraid of "catching a wiggling" if she were told on, hence her request to Mr. X. not to mention that she stuttered, by which her personality would be known. Miss B. learned this fact from one of her letters to herself.

During the next few days (the last of October and the early part of November) several opportunities occurred to confirm by personal observation the character of the trances and the nature of the "irresistible impulses." At each interview I was treated to an exhibition of rebelliousness on the part of Sally, who would appear spontaneously and unbidden. I also had an opportunity to witness several scenes in which Miss Beauchamp was "possessed by something inside of her," thus confirming her statement by actual observation. These phenomena will presently be described. Before long, sufficient were manifested in my presence to support all that Miss Beauchamp had said. Sally plainly had broken loose again.

One of the most embarrassing things in Sally's conduct was her making engagements with people, and with one person in particular who may easily be guessed. Aside from the effect which these engagements had of putting Miss Beauchamp into trances, there was no particular harm in Sally's youthful loyalty, or there would have been no harm if Miss Beauchamp herself had not felt so strongly about discontinuing the old relations. It was many months

before the secret of the past and the psychological reason for the anxiety of Miss Beauchamp were revealed. Long afterward, when the history of a psychological catastrophe was obtained, all became clear. Thus it was that, morbidly exaggerating in her own mind the seriousness of it all, Miss Beauchamp had gone so far as to promise to break with the past. Now she found herself, in spite of her will, faithless to her solemn promise. The breaking of her promise was the basis of her unhappiness and anxiety.

The way it worked practically was this: Sally would make an engagement for a definite hour. This to all appearance would act as a post-hypnotic suggestion. When the hour arrived — just as a hypnotic subject carries out a suggestion previously given in hypnosis, so Miss Beauchamp, no matter what her own engagements were, where she was, or what she was doing, would change to Sally, and off Sally would go to carry out the pre-arranged programme. How I did bless Jones, and how much trouble he did cause! I dare say he was innocently unconscious of it all, nevertheless the trouble was just as great and the consequences as disastrous as if all had been done with dire intent.

It was found necessary to lecture Sally severely on her conduct, although it soon became evident that scolding had very little permanent effect. Sally was too childlike and volatile in character to be influenced in this way for long. Nor did pleading have more than a temporary effect. She would respond to be sure by becoming repentant and would then promise anything, but she simply could not keep her promises. The only other practical methods to influence her were by suggestions to B II, which Sally found it difficult to counteract, and by hypnotizing Sally herself. The latter was a disagreeable process, as it had to be done forcibly against her will, she

all the time kicking and struggling, both mentally and physically. Consequently it was never resorted to except in emergencies.

My time was largely occupied in thwarting Sally's plans, and for this her wrath would be called down upon my head. It is fair to say, however, that her anger did not last long. She could be easily turned to merry amiability by a pleasant word. You had only to distract her attention from a grievance, to suggest a new pleasure, and the look of anger was gone and that of friendly merriment beamed upon you. I was always sorry to have to play the stern moralist. Those savage letters which she sometimes wrote in no way did her amiability justice or gave an idea of her character, beyond that of her entire lack of any conception of responsibility and of worldly knowledge. Excepting in these moods, her frolicsomeness, gayety, and love of fun were irresistible.

An apparently thoughtless word at this time was the cause of a foolish annoyance. Sally got it into her childish head that she was seriously invited to go to Europe. The plan was preposterous, and probably arose from some jocose suggestion on the part of her old-time friend Jones. Nevertheless Sally took it seriously, as will appear from her letters. Miss Beauchamp, hearing of it, also took it seriously, and was in a state of terror, not knowing what Sally might do. Sally seemed to her mind capable of anything. Two letters found by Miss Beauchamp on coming out of a trance, and written while in that state, referred to this European trip in a way that gave no doubt about Sally's view. They were sent to me by Miss Beauchamp, enclosed in the following letter:

"I enclose two of the notes you wished to see. I cannot tell you how ashamed I am that I could have written such things, whether consciously or unconsciously. Forgive me for mutilating them. I really had to, a little. The third, from Jones,



it is impossible to send you because it does not seem quite fair to him. Are you cross with me for making that arrangement this morning without consulting you? I am so sorry if you are, but it can be easily undone. It was only my extreme terror that suggested it. It seemed as if I must keep in touch with some one, and I wanted that some one to be you. But it was very thoughtless and foolish of me, and I am truly sorry.

"Thanking you so much for all your kindness and patience, I remain,"

The first of the enclosed notes was from Sally to me and ran as follows:

"I hate you, hate you, hate you, for an utter barbarian — and we are never coming to you again. She shall not be hypnotized — do you understand? Jones is going to take us away — very, very far away, where you cannot possibly come, and we are going to stay with him and love him for always. And *you* may walk on the hip. You shall not make me any more trouble, and you shall not have the pleasure of seeing me squeezed<sup>1</sup> again. She cannot do it now, for she is awfully wicked herself, although she does n't tell lies as you do. This from,"

"Please be good, and write her that you are *so* busy she must not come at present. *Please, please do.*"

[Sally to Jones.] "Won't you please come and take me away right at once? Some one — I cannot tell you who — is going to hypnotize me and make me so awfully good that I won't ever be allowed to see you again. And I want you *not to let it be done. Please take me away.* I do truly want to go, and I'm not making a fool of you this time. I'm going to be awfully reasonable, and I won't forget any of the notes I write or the things I say, and I *will* love you a great deal, — if only you please won't be so very much in earnest. I don't like it, you know. Come to — about five-thirty to-morrow, and we will do our planning all over again. It will be such fun, won't it? and we will leave all this dreary unhappy life behind us, and never be sorry any more. But you must not let me be hypno-

<sup>1</sup> See footnote, p. 97.

tized again — that is true really — it spoils everything. Don't ask me any more about it, for there is a very special reason why I cannot tell you. *Only* we must stop it. Isn't this a *very* nice note? Until to-morrow, then,"

The childlike character of these last two letters is too obvious not to be seen. One might imagine them written by a child of twelve or thirteen years. In interpreting Sally's actions this child character must always be kept in mind. But her individuality was complicated by the fact that though a child in mental development, she had had the benefit of the adult experiences of Miss Beauchamp, and therefore had more knowledge and culture than a child. Yet she looked at everything from a child's point of view. Her general attitude of mind and her actions were those of a very young girl, as were some of her ideas of fun, and particularly her love of mischief. One of the principal difficulties in managing her was the impossibility of making her see her own conduct from an adult point of view.

There are two or three expressions in these letters which are very suggestive. In the second Sally says, "I'm not making a fool of you this time. I'm going to be awfully reasonable, and I won't forget any of the notes I write or the things I say." Reading between the lines, it is easy to understand to what this refers. It was Sally who had written the letters, made the engagements, etc. Later, the personality changing to Miss Beauchamp, not only the attitude and manner changed from friendliness to great reserve, but Miss Beauchamp denied everything she had said and done, and even the authenticity of the letters. It must indeed have seemed that she was making a fool of her correspondent. But Sally, who of course knew the ins and outs of it all, protests that "this time" she is not going to make a fool of him, because she hopes that if she can prevent herself and Miss B. from being hypnotized she (Sally) can stay always.

I have often been asked how Miss Beauchamp managed to get on while she led such a double life. In one sense she did not get on, except at the expense of enduring every sort of annoyance and disappointment. The following incident illustrates one kind of annoyance, for which, however, Sally was not directly responsible.

It had been arranged that Miss Beauchamp was to telephone every morning in regard to her condition. On Christmas morning I was called to the telephone, and at once recognized the voice of one member of the family by the stuttering, cheerfulness, and general tone. It was unmistakably Sally. The next day, Monday, I received the following note, written Christmas night, showing that the writer had no knowledge of having (as Sally) telephoned me Christmas morning:

"I beg that you will forgive me for neglecting to telephone you as you wished this morning. I have lost the past twenty-four hours absolutely — as if it were twenty-four seconds.

"Very sincerely yours,"

I soon learned what had happened from both Miss Beauchamp and Sally.

On Saturday afternoon, the day before Christmas, Miss Beauchamp was in church, sitting on the *right hand* side, and the choir was singing the processional. Then all of a sudden, so to speak, she found herself on the *left hand* side of the church, though *they were still singing the processional*. How she had changed her place she did not know, though at the time she supposed she might have had a trance and made the change. Having learned by experience not to give herself away, she said nothing, but after leaving the church with her friend Miss K. she remarked to her, "We are going to have a cold Christmas." At this Miss K. laughed, which she thought queer. She had sufficient presence of mind to say nothing

more, but was rather surprised that Miss K., who had previously asked her to spend Christmas Eve with her, said nothing about it. She was further surprised on reaching home to find Christmas gifts about. All seemed to have changed since she left home for church. It was not long before she discovered that twenty-four hours had elapsed since she first entered the church, and that during this time Christmas had come and nearly gone, though she remembered nothing of it. The music of the processional had apparently put her into a trance, and this same music had, twenty-four hours later, waked her up again.

It transpired that Sally had enjoyed Christmas Eve with Miss K., and in fact had fulfilled all the family engagements. Therefore Sally had her Christmas, but Miss Beauchamp, to her disappointment, lost hers.

Another incident, illustrating how Miss Beauchamp did not get on, is worth recording on account of its psychological importance. It shows not only the coexistence of two minds, but the coexistence of a subconscious sane mind with a delirious mind.

I was summoned to visit Miss Beauchamp at the house of Miss K., where she was said to have arrived the previous evening in a delirious condition. She was still delirious on my arrival, and did not know me or her surroundings; but Sally, with whom she kept alternating, was perfectly sane, and rather delighted with the condition of affairs. I was never able to learn exactly what had happened to cause the catastrophe, nor could Miss Beauchamp recall the incident excepting in a fragmentary way.<sup>1</sup> It is fairly

<sup>1</sup> Miss B. afterward wrote: "All the arrangements for leaving there [her own lodgings] were made by Sally, who pretended that she was acting under your instructions. I believed that she was, — yet your strange silence, and my own inability to speak of the hospital made me very uneasy. I felt there was something wrong, although I did not know what. The last day there made me fearfully nervous, frightened, hysterical: everything was so strange, and you did not come or send any word. From that time my recollections are very scrappy indeed. I remember being in some station in the evening (—,

clear, however, that Sally, taking advantage of a suggestion of mine that it would be advisable for Miss Beauchamp to go to a hospital for a few days, and pretending that she was acting under my instructions, had packed her trunks and sent them away, leaving only a handbag with the few things necessary for travelling. The scheme must have been very carefully planned, but where Sally carried Miss Beauchamp before ending at Miss K.'s is a mystery. The next scene of which I was a witness was psychologically impressive, not to say dramatic.

Miss Beauchamp did not recognize me, or Miss K., or her surroundings. In her delirium she was living over again, I think, some event of the past. She imagined herself at Cohasset, and awaiting some one. She was in great distress. When I endeavored to bring her to herself, Sally at once appeared instead, laughing and treating the matter as a great joke. There was not the slightest trace of delirium or mental disturbance about this secondary consciousness, who disclosed the content of her other self's delirium. The two personalities, the delirious and the sane, kept spontaneously disappearing and alternating with each other. Sally even agreed to act as nurse, and to "come" at intervals and take the prescribed food which delirious Miss Beauchamp refused, — an agreement which Sally carefully observed.

larger, I think), and afterward I remember being driven slowly over some very bumpy roads. It was still dark, and raining hard. There was no one with me, I am sure, for I kept wondering why you should have sent me alone instead of coming with me as you had before. Then I remember a nurse or maid — some one all in white with white cap — bringing me a cup of hot beef-tea; then Miss K., sitting opposite me in her room talking; then looking at my watch and finding it a quarter to four. From a quarter to four until a little after six I remember everything. Then after that nothing, — except my despair at finding your letter destroyed and the pieces threaded on a long hat pin in my hand. In the evening I saw the street very distinctly for some minutes; then I remember being startled by a tremendous report close to my head, and turning I saw Miss K. with a pistol in her hand. . . . Then it was morning again and I saw" — [unfinished]. Miss K. informed me she had fired off the pistol with the idea of producing a shock that would bring Miss B. back to consciousness.

When one stops to think about it, the coexistence of a normal mind with a delirious mind in the same individual seems a curious phenomenon, but it is one which has been recorded before. To observe before one's eyes a delirious personality suddenly change to a sane one, and *vice versa*, would have been startling if we had not become accustomed to strange things in this strange case. Then, again, to be informed by one mind of the delirious vagaries of the other mind showed very conclusively the distinction between the two. To state the matter in another way, here was a delirious person within whom there apparently existed a sane personality, cognizant of every delirious thought and action, able to report upon everything that took place within and without, acting as nurse to the delirious consciousness, coming at the appointed time to take the prescribed remedies, and giving warning to the physician of the mental perturbation.

Miss Beauchamp became a puzzle to her friends, who did not understand her changing moods. These "moods" really meant a transformation into and from Sally, who thus came more frequently into touch with social life. Indeed, Sally was fast getting to "the top of the heap," as she wrote when she first got her eyes open. She was "coming" more readily and more often, so that Miss Beauchamp seemed to herself to be "losing" a greater amount of time. Miss B. felt too, as she wrote in one of her letters, that she was "possessed." "Losing time" meant that Sally was absorbing a greater part of Miss Beauchamp's life.

Sometimes, though this was more common at a later date, the transition from one personality to the other would take place during the course of a conversation. Then Sally, knowing Miss Beauchamp's thoughts, could go on with the conversation and play her part; but Miss Beauchamp, if she came to herself at such times, exchang-

ing places with Sally, would be at a loss to know what had gone before, and at her wits' end not to betray herself. Sally, on the other hand, used to impersonate Miss Beauchamp, copying as far as she was able her mannerisms and tone. At other times, forgetful or heedless of Miss B.'s character, she would throw herself into the game, regardless of consequences, giving vent to her own frolicsome irresponsibility, while her friends would gape at the sudden transformation of serious, dignified, reticent Miss Beauchamp. It must have been puzzling, as I have been assured it was, to see a person suddenly change in mood and expression, without apparent rhyme or reason; at one moment exhibiting the irresponsible, heedless, high spirits of youth, and the next moment, in the twinkling of an eye, becoming depressed, sombre, and grave. Again, as Sally she would make statements, assertions, promises, and engagements which as Miss Beauchamp she would deny, to the discomfort and confusion of her friends. Many of the contretemps resulting from this, sometimes amusing, sometimes annoying, will come out in the course of this study. But it is not fair to credit Sally with naughtiness only: the Recording Angel must inscribe many good deeds against her name. She was not always reckless and regardless of the family reputation. *Excepting* where her own amusements or her own special wishes were concerned, she generally protected Miss Beauchamp, particularly with strangers, pretending as I have said to be the same personality, copying her manner, going on with the same conversations, and doing the same things that Miss Beauchamp had been doing a moment before. Similarly she would perform her daily duties and even loyally carry out her engagements, provided they did not conflict with her own plans.

Sally should be credited also with keeping me informed of the various disturbing elements in Miss Beauchamp's

life (at least those for which Sally herself was not responsible) that from day to day acted injuriously upon her nervous system, exciting the nerve storms and shocks to which reference has already been made. Often it was Miss Beauchamp's own meditations and emotions which were the offending factors, and on these Sally kept me well posted. Miss Beauchamp, for reasons already given, was exasperatingly reticent about such matters, and kept me in the dark about much that it was important to know. Sally's information, which always proved to be correct, was a great help.

On the other hand, Sally's motives were not always so lofty, for with me it was often for the purpose of obtaining her own way that she would impersonate Miss Beauchamp. When blocked in some design I have seen Sally over and over again attempt to pass herself off as Miss Beauchamp, but the pretension could always be detected after a moment's observation. I have also frequently seen Miss Beauchamp struggling against "something inside of her," as she termed it, which it required no prophetic knowledge to guess was Sally trying to compel her to act against her own wish. And when Sally was foiled in this, owing to my intervention, that young phenomenon would force Miss Beauchamp out of existence, and coming herself would seek in disguise to escape from the room.

In these scenes two closely related phenomena of considerable psychological importance were brought under direct observation, namely, *aboulia* and *impulsions*. The latter phenomena had been frequently complained of by B I, and frequent reference has been made to them, but no opportunities to actually observe them had been presented. The incidents which will be related in the next chapter confirm the statements of the victim of these obsessions.



## CHAPTER VIII

### SUBCONSCIOUS BATTLES: ABOULIA, IMPULSIONS, OBSESSIONS

IT probably will be asked in connection with the phenomena and events about to be described in this chapter, How much did Miss Beauchamp know at this time about the nature of her infirmity? In a psychological sense she knew very little, but regarded herself as one "possessed" in much the same sense as it is said in the Bible that a person is "possessed." She was well aware that she went into trances and in those trances did extraordinary things, and behaved in a way that shocked her sense of propriety. She realized, too, though in a somewhat indefinite manner, that her possessions at times influenced her every-day actions, and in some way interfered with the freedom of her will. But the psychological nature of these attacks was unknown to her, and in fact was carefully concealed, so that her knowledge was very indefinite. She was ignorant of the phenomena of the multiple personalities, and was not allowed to know that her trance state was a second veritable personality which persisted in a more or less sharply differentiated form as a subconsciousness during her normal waking state. It was necessary at times to inform her of what she had done during her trances, and sometimes to warn her of plans and intended escapades which in this state she had concocted, but her trance doings were always spoken of as her own, as if done by herself in a state of somnambulism. Sally's letters she regarded as her own trance vagaries, and Sally's signature

as a name used by herself for the purpose of carrying out a part. Her feelings of being "possessed" she connected in an indefinite way with her trances and realized that from time to time her mind and body were controlled much as one might be controlled by convulsive phenomena. Although her idea was somewhat vague, she inferred that this control was due to one part of her mind acting upon the other part and upon her body. This really was the actual feeling that she had when "possessed," and against this possession, when it came upon her, she struggled with all her will. I think this conception, too, was vaguely connected with the ethical idea of punishment for sins, and hence the diabolical nature of the possession; and she half believed that by punishment and prayer her devil was to be cast out of her. But her conception involved no definite notion that that which possessed her was in any sense of the word a distinct subconscious personality, differentiated from herself, anything to which a personal name might be given.<sup>1</sup> With this explanation in mind, it will be easy to properly interpret her position in connection with the following phenomena:

*Aboulia and impulsions.* It has been already explained that by *aboulia* is meant an enfeeblement or paralysis of the will. It may originate in several ways. It may, for instance, originate in conditions confined entirely to the field of the waking consciousness. The ordinary *aboulia* which Miss Beauchamp exhibited, that which expressed itself in morbid reticence, for instance, had such a pathology. But it also may result from the influence of subconscious ideas. On several occasions Miss Beauchamp gave manifestations of this variety. Then Sally, by exerting her will against that of her other self, could produce

<sup>1</sup> Such a notion would involve an interpretation of the phenomena. At this stage of our study I do not wish to be understood as committing myself by implication to any precise hypothesis, beyond that of a subconsciousness of some sort.

an inhibition of such a degree that Miss Beauchamp would find herself unable to will the simplest act, whether it were speaking, writing, studying, or walking.

It has been also explained that by *impulsions* (synonyms: obsessions, imperative ideas, zwangsvorstellungen) are meant imperious impulses to some action which may be against the person's own wish and will. The person is often painfully and helplessly conscious of their domination. It is now well recognized, thanks to the work of Janet, that these phenomena may in certain cases be the action of fixed ideas or emotions in a second consciousness unknown to the waking self. The impulses by which Miss Beauchamp complained that she was tormented were plainly of this nature. The way she told ridiculous lies at an earlier period has been already described, as well as the impulses of a different form, which soon after her return from Europe gave her the sense of being "possessed." The evidence for these facts had thus far rested upon the complaints of the subject, but the following incident illustrates a struggle actually observed between two consciousnesses; the action of one upon the other resulting in both aboulia and impulsion. Miss Beauchamp, at first unable to write a letter, ends by being the victim of an imperative impulse.

One day, early in November, Miss Beauchamp came to the consulting room, for the purpose of writing a letter in my presence. This letter was intended to explain the nature of her malady to her unconsciously troublesome correspondent, Jones, who was ignorant of her mental disability. It was hoped that the letter, being countersigned by me, would put an end to the correspondence and engagements in which her irresponsible self still persisted. It never occurred to me that Sally could thwart this scheme.

Miss Beauchamp sat down to write the letter, but at once met with a difficulty. She succeeded in writing a few lines, but all the time kept repeating, "Don't

let me go [meaning, out of the room], Don't let me go." Her tone was pleading, and her manner nervous and agitated. She gave the impression of struggling against some controlling force,—something that was taking possession of her brain and muscles against her will. The expression of her face was worried and depressed; her movements halting and jerky. She made every effort to write, but kept stopping and constantly shifting her position, sometimes half rising, then sitting again; at one moment throwing down her pen, then taking it up, repeating meanwhile in a supplicating way, "Don't let me go." I changed my seat to one between her and the door, remarking that it was now physically impossible for her to go. Thereupon she became more quiet. Presently she altered her tone and said, "Please let me go." This phrase she would repeat in reply to every remark made to her. The nervous manner had disappeared; her face was placid and serious; her movements no longer agitated; the tone of her voice, although composed, was not depressed. What did the change mean? Plainly the obsession had ceased. I felt certain that it was Sally trying to pass herself off as Miss Beauchamp, and in this disguise escape. Charged with the fact, and put to the test of reading French, which this personality could not do, she at first evaded, but soon, seeing that she was caught, burst out laughing and showed herself in her customary colors, enjoying the joke.

Such scenes as this were the outcome of a contest of wills,—of Sally's will against Miss Beauchamp's will. Later and frequent investigations demonstrated this origin of the phenomena. In these contests Sally usually won, and Miss Beauchamp's will would be paralyzed. The latter would not only find herself unable to will to do what she wished, but often was actually compelled to do something she did not wish to do. Over and over again Miss Beauchamp has tried to tell me something of importance,—

something concerning her welfare, and of which she had purposely come to give me information, but which if told might thwart Sally's schemes, and as often, after vain effort to speak, she has given it up, remarking, "Well, it does n't matter." The same phenomenon has been manifested by B II. This was nothing more nor less than *aboulia*. Arising in the manner described, it was of importance in that it showed the existence of a secondary consciousness, concomitant or coexisting with the habitual consciousness. For two wills to contend against each other they must coexist. Sally, then, did not simply alternate with Miss Beauchamp, she coexisted with her.

In connection with the matter of detecting Sally when masquerading as Miss Beauchamp, I have often been asked how one personality differs from the other. Of course the mode of speech and mannerisms of each differ, but more than this, it is a very interesting fact that with both Miss Beauchamp and Sally every mood, feeling, and emotion is accompanied automatically by its own facial expression, so that, as each individuality has a dominant, and for the most part continuous, emotional state of mind, each wears a corresponding expression, different muscles coming into play in each. By this expression alone it is generally possible at a glance to recognize the personality. As this expression is purely automatic and the accompanying resultant of the emotion, it is impossible for one personality completely to simulate the other. When Sally tries to impersonate Miss Beauchamp the best she can do is to look serious; but as she does not *feel* serious, or actually have the emotion or mood of Miss Beauchamp, her face does not assume the expression of that personality. Occasionally Sally will have for a moment, under the influence of some event, such as a scolding or threat of punishment, a depressing or anxious emotion identical with that of Miss Beauchamp; then her face will wear an expres-

sion indistinguishable from the latter's, but as a rule these variations are only momentary.

Three weeks later, November 21, another and similar incident, in which aboulia and impulsions were manifested, occurred. This incident had an amusing side, though it led to what almost might be called "a fight to a finish" between the two personalities. The first letter to Jones, eventually written and sent, having failed to accomplish its purpose, owing I suppose to the fact that it was too great a tax upon the credulity of her correspondent (Such is the wisdom of the uninformed!), it was arranged that this time I should dictate the letter, Miss Beauchamp merely copying it. She had come for this purpose. On entering the consulting room she appeared restless and nervous, saying constantly that she "must go," she could not stay, she would come back, etc., etc. Her manner plainly indicated that she was struggling against some force which was impelling her to go. Finally she said that she felt as if "possessed"; that something not herself was trying to prevent her from staying. For its moral effect, I locked the door. Still she was so restless that after making a futile attempt to write the letter she had to give it up. Soon, as might have been anticipated, she changed to Sally, who as before attempted to escape in the disguise of her other self. As usual, Sally enjoyed the joke, but her merriment turned to rebellion as soon as an attempt was made to control her. With much violence of feeling she objected to the letter, and to anything being done for Miss Beauchamp, calling her "a chump," "stupid," etc. It became necessary to resort to hypnotism, which resulted in the confession of the details of an engagement for the following Wednesday at eight o'clock in the evening. After quite a scene and the usual lecture on her behavior, Sally became submissive and promised not to keep the engage-

ment. She was then changed back to Miss Beauchamp, who *calmly and easily* wrote the letter as dictated.

Miss Beauchamp complained again of her position, saying it was "terrible," that it was a "fiend" that was bothering her, etc., etc. A few minutes later Sally again came upon the scene and at once revealed herself by mimicking and jeering at her other self. She was irresistibly funny, in spite of the tragic side of it all. "Really," she said, copying the tone and manner and repeating the very words of Miss Beauchamp, "Really, Dr. Prince, I must be possessed; a perfect fiend is in me. I don't know what I shall do! Such a horrible thing! I should think, Dr. Prince, you would hate me." Then she broke into a peal of laughter.

The appointed hour for Sally's escapade, be it remembered, was eight o'clock in the evening of the following Wednesday. In the afternoon of the same day, at three o'clock, Miss Beauchamp had agreed to pay me a visit. When these hours arrived there was witnessed by those about her a most remarkable exhibition of phenomena, which can only be interpreted as those of impulses on the one hand, and on the other, as a struggle between two coexistent minds in one body. My information about it came in this way: In the afternoon or early evening I received two notes: one from Miss Beauchamp, and one from Mrs. R., with whom she was boarding. Miss Beauchamp's letter ran as follows:

"Will you please send me some morphia? The bromide does n't help, and I am thoroughly upset. I can remember, really I do remember, but things are trying to slip from me, and I am so nervous and tired. I want to sleep too, and I am stuttering awfully. It is so dreadful — all of it — but if you will send me the morphia I shall surely be all right to-morrow. Please, please do."

The other letter, from Mrs. R., stated that Miss Beauchamp was in poor condition and asked advice.

Later in the evening Mrs. R. telephoned that she was quite alarmed about her charge, who was restless and nervous and in a queer state. On my arrival, about 11 o'clock, I found Miss Beauchamp stuttering badly, and in a mental condition resembling that of a person lightly hypnotized. A few suggestions restored her to herself. The following facts were then learned: Mrs. R. stated that at about three o'clock Miss Beauchamp had acted very curiously; "jumping and squirming and wriggling about" in the most remarkable manner. At about eight o'clock this was repeated. Miss Beauchamp stated on her part that at the earlier hour she had made an effort to leave the house to keep her appointment with me, but that she simply could not keep it. She felt herself controlled by something which prevented her. She had become very restless and was obliged to give up her intention. Later in the evening she had an almost irresistible desire to go out of the house, without any definable aim. Between seven and eight o'clock this desire became strongest, and she was then at her worst. Concluding that this impulse was one of her possessions she determined to fight it. Though beaten in the afternoon this time she had won the victory, much to her delight, but from all accounts it had been a "nervous" afternoon. As to the stuttering, she felt as if some one had control of her tongue. The next morning Miss Beauchamp received the following letter from Sally:

"I am positively ashamed of you, my sainted Christine, that you should pretend to be shocked because I choose to go to — with poor dear W. I shall go with him just as often as I choose, in spite of you, and in spite of Dr. Prince too, and you know that you have been no end of times. You are sneaky, just sneaky, and if I were you I'd confess my own sins before I began bewailing those of other people. And please let Dr. Prince alone. He tells lies and squeezes people, and he is perfectly horrid to you too. Do be reasonable and we can get on



loads better. I won't be squeezed. I just won't. I'll make you all dead first. Your prayer book is in the salt-box covered way up, if you want it. Perhaps you'd better rescue it so that you can pray out of it. And your silly old examples for the red-haired one<sup>1</sup> are all in tiny wee pieces which you may enjoy putting together again, as long as it is so awfully important you should do that sort of thing. You are afraid of everybody — you are — nobody wanted you to go with W. last night and you ought to be sorry you did not take me for a walk instead of staying at home and kicking up such a row. Dr. Prince wanted to shake you, and so did Mrs. R., and I just wish they had. Nobody shakes you even when you have ultr<sup>2</sup> motives and I am always getting [word omitted; scolded?]. The Margaret Margaret<sup>3</sup> is all gone too. I made cigarette papers out of it. Are n't you glad? I did it all for you. I knew you'd like it, so good-bye dearie, and don't you dare go anywhere unless I tell you you may.

“Your affectionate guardian.”

That same afternoon Sally boasted that she had made Miss Beauchamp stutter; that she had prevented her keeping her appointment with me; and that she had produced the desire to go out in the evening, although she had no intention of keeping the engagement, intending simply “to take a walk.” She had done all this by the process of “willing.”

A comparison of Sally's letter with the following from Miss Beauchamp enclosing it is interesting as showing the difference in the characters of the two personalities:

“I do hope this evening's accident<sup>4</sup> has proved less serious than Mrs. — feared when I saw her, and if my delaying you

<sup>1</sup> One of her teachers.

<sup>2</sup> Ulterior. This was a new word Sally had learned from me, and it was evidently too much for her.

<sup>3</sup> Some literary work which represented much labor.

<sup>4</sup> Referring to a carriage accident by which my horse was killed. The accident occurred while my carriage was waiting for me during Miss Beauchamp's visit.

was in any degree responsible for it all I can only hope that you will believe I regret it from the very depths of my soul. You must not tell me to come to you again, *ever*; not wholly because of this that has occurred, but partly because for a long time I have felt that I have been trespassing far too deeply on your time and patience. And through it all I have done so little to help you, so much to hinder! It is only childish, as you say, to keep repeating that one is sorry, so very sorry, for all these things. This time I hope to be stronger. I enclose the note you asked for and only wish it may be of some interest psychologically—it is utterly absurd from any other point of view. Do forgive me as many of my sins and shortcomings as you can, and believe that I shall be always infinitely more grateful to you than I can say.”

The habit which Sally had of making engagements unknown to Miss Beauchamp was becoming seriously troublesome. It not only interfered with Miss Beauchamp’s own plans but it distressed her to discover later that in this interval of lost time she had carried out plans objectionable to herself, even to reversing what she had previously said and done. Then as Sally found amusement in writing letters to Miss Beauchamp, telling just enough of what she had done to allow Miss Beauchamp to infer the worst, the latter’s imagination would run riot, conjure up all sorts of possibilities, and inspire a state of terror. The letters would allude to matters of which she was ignorant, and therefore keep her mind in a state of apprehension.

Here is a specimen of Sally’s letters; others will be given in the next chapter:

“You dear, sweet, good, little girl! Never heard of Jones before, did you? No wonder Dr. Prince is utterly disgusted with you. Cannot even confess straight! I shall tell him everything, and then you’ll see what he thinks of you. ‘Damned from here to eternity,’ just as Jones says.

- |                  |                  |
|------------------|------------------|
| 1. Childish      | 6. Foolish       |
| 2. Emotional     | 7. Imprudent     |
| 3. Stupid        | 8. No discretion |
| 4. Selfish       | 9. False ideas   |
| 5. Inconsiderate | 10. Infant.      |

Miss Devil Lady.”

The final epithet, referring to Miss Beauchamp's feeling of being possessed by a devil, Sally frequently scribbled over Miss B.'s letters. The ten sins are expressions which she had picked out of various criticisms made upon her by Jones, without regard to the context. The sins with which poor Miss Beauchamp was charged are presumptive evidence of mistaken identity, for no one could look upon her as childish, or inconsiderate, or selfish, unless they mistook her for her subconscious self, Sally. The ingenuity which that self displayed in sticking mental pins into Miss Beauchamp by means of letters was quite remarkable, hinting as she did in a most subtle way at all sorts of occurrences dreadful to contemplate.

What was the secret of all this tormenting, this abuse of her other self? They were after all the same being, inhabiting the same body, — though no amount of argument could persuade Sally to admit the fact. Why then should Sally delight in annoying herself? There were several reasons:

In the first place, Sally disliked the life she was perforce obliged by Miss Beauchamp to live. Sally loved an outdoor, breezy life; sports, amusements, physical activity, games, and the theatre. It was tales of adventure and of outdoor life, of hunting and riding, that she delighted in, and that I often had to tell her to satisfy her longing. And here was Miss Beauchamp devoted to duty and study! In the latter's life pleasure and recreation rarely entered. Sally complained bitterly of Miss Beauchamp's studious habits, and used to paralyze her will so that she could not

study. "I hate those stupid old books," she would plead in extenuation. "What does she always want to be reading them for? What is there for me to do?" She thought it hard that she must be quiet and passive while Miss Beauchamp could do as she pleased. And it was dull for her when her other self was occupied with such uninteresting matters.

Then, in the second place, teasing seems to be the natural outlet of youthful minds. It seems to appeal to the sense of fun of every boy and girl, particularly when a vent for animal spirits cannot be found in physical exercise.

But above all, perhaps, the reason is to be found in the fact that, strange as it may seem, Sally hated Miss Beauchamp. "I hate her, I just hate her," she would reply to every remonstrance on her conduct, and whenever upbraided for molesting herself, — her other self. The reason for this hatred was still more strange. It was jealousy. This showed itself in various ways. She was jealous of Miss Beauchamp's superior attainments, of her culture, and above all of her popularity with her friends, and of the care and solicitude shown for her. She was jealous that we who were interested in her case were trying to keep Miss Beauchamp in existence in preference to her secondary consciousness, Sally. "Nobody seems to care what becomes of me," she would complain, when a plea was made that Miss Beauchamp's life should not be interfered with.

The following letter from Miss Beauchamp shows her condition of mind resulting from the various trials she had undergone:

"I have been losing time again, and hasten to let you know at once, as I promised; although I am much afraid that you will consider it my own fault because I have not been taking things philosophically. But, really, everything is upside down, and when things are in that condition it is hard to be philosophical, even though one realizes that not to be ' shows a lamentable

want of strength.' I got extremely tired on Friday, going about with Miss ——, and by the time I had seen her off on the train, I was not merely tired, but nervous and overwrought, so that coming upon Jones unexpectedly in the evening was a great shock to me. He was so angry — more angry than I have ever known him — and was delightfully frank in telling me not merely what he thought, but what you must of necessity think concerning me. But, indeed, Dr. Prince, you *cannot* think such things if your knowledge and understanding of me are as absolute as I believe them to be. You simply cannot, — and yet I have been able to think of little else these last few days. I have tried to tell you everything — not at first, I know, but since then — and even without my telling you know my very inmost thoughts. There is only one thing I have kept from you and that is nothing you would wish to hear. . . . I am afraid this note is not very coherent, as I am writing in the greatest haste and my ideas are mixed, but you will forgive that, I know, and believe me,

“Sincerely yours,”

One of the most distressing things to Miss Beauchamp was her inability to keep her promises, owing to the freaks of Sally. The fear of failure was a source of constant anxiety, for never in practice did she look upon herself as irresponsible, or consider that in her trances she was another person. Her point of view was simply that she was transformed at such times and acted differently from what she desired in her normal condition. “It is myself, after all,” she would say, pathetically. So when she promised, for example, to keep me informed by letter of her doings, or what was more important, not to correspond or keep up associations with certain persons, she was in constant terror of breaking these promises, though the one who broke them was Sally, not herself. To her it seemed to be herself. Indeed, Sally did everything she could to break any promise of Miss Beauchamp if it crossed her own purposes. As we have seen, she destroyed Miss B.’s letters

as fast as they were written, she corresponded when forbidden, and she made engagements which Miss Beauchamp was in honor bound not to fulfil.

Mrs. X., one of Miss Beauchamp's friends, did not realize this, and in putting her on honor, so to speak, naturally, though always charitably, thought it Miss Beauchamp's fault if she failed in her promises. Miss Beauchamp never sought to exculpate herself by putting the blame on her subconscious demon. Her only answer was self-accusing silence, or "It is myself," though to me she would explain her situation that I might understand, making no attempt, however, to excuse herself. The following letter gives an insight into her mind :

"I have failed miserably in keeping my promise to tell you about things, but you will believe that I have tried? tried until I am nearly beside myself with pain and vexation, but it is useless. My attendant demon is too much for me and destroys faster than I can write. You know it has always had a strong dislike for you for some reason or other, and it is very much devoted to Jones. I dare not make this explanation fuller lest this note follow the others. You will understand, I am sure."

*Subconscious fixed fear.* One very interesting phenomenon noted at this time, and frequently observed later in varying forms, was a feeling of fear which seemed to well up, so to speak, out of the depths of the subconscious strata of her mind. She complained of an indefinable, unreasoning fear, without any particular basis or specific object. It would come over her in attacks many times a day, and particularly at night, last a few moments, and then subside. It was another form of obsession.

The obsession of fears (fixed-fears, *Angst-Neurose*), is well recognized in neurology, though a knowledge of its pathology is not as widespread as it should be. A great many people are its victims and often go through life tor-

tured by apparently groundless fears, and misunderstood by their physicians as well as by those about them. Sometimes the fear is indefinable and not associated with any particular object. More often it is connected with some particular thing, as fire, disease, or drugs; very commonly it takes the form of shyness. Such fears may have their origin in subconscious mental states of which the habitual self has little or no knowledge. Such fears always arise originally, of course, in some conscious experience, but later they become dissociated and crystallized as a secondary subconsciousness,<sup>1</sup> along with the memory of the event which gave rise to them; then from time to time the fear, without the associated memories, becomes synthesized with the waking self, and the subject experiences an objectless, indefinable fear which appears to be without cause.

Fears of this kind form a well-recognized psychosis, one with which we have to deal in every-day practice. If this were the proper place I could give from my notebook numerous instances of this phenomenon in other subjects. A. B., a schoolboy, is overwhelmed by attacks of indefinable fear, which the history showed originated in a fright at the thought of an imaginary illness. Mrs. C. D. has similar attacks, which hypnosis discloses developed out of a fainting attack in early girlhood twenty years before. In other instances the fear or anxiety is not absolutely indefinable, but is associated with certain indefinite memories and thoughts which, however, lack clearness and are incompletely formulated. In such cases a portion only of the memories upon which the fear depends remains subconscious and dissociated. In still other cases the whole of the obsession belongs to the waking consciousness, and then the fear is precise and definite.

<sup>1</sup> It should be understood that by the secondary subconsciousness is meant, in the case of Miss Beauchamp, not the group of conscious states called Sally, but another group which in hypnosis becomes a part of the hypnotic self, B II.

Manifestations of one or the other kind of subconscious phenomena have often been observed in Miss Beauchamp. It has only been necessary to catechise the hypnotic self to learn their whole content and origin. In the present instance the subconscious fear originated from a very specific fear and anxiety about a specific matter which is quite distinct in her mind and which she now distinguishes from the indefinable fear. This specific fear was that she would break a promise made to Mrs. X. and it had come upon her as a nervous shock on discovering that this danger threatened her. It arose in the following way: Miss Beauchamp had received a letter from Jones which plainly indicated that she as Sally, and therefore unknown to herself, had made a promise which involved the breaking of her promise to Mrs. X. When she read the letter she discovered her danger, and it aroused in her a great fear, — a fear that in spite of herself she would break her promise. I taxed Sally with this intended escapade, harmless in itself, but she obstinately persisted in her purpose, saying, childlike, that she didn't see why she shouldn't, and so on. Although Miss Beauchamp knew nothing of this beyond what was contained in the letter, she knew enough, remembering the past, to feel herself upon a powder magazine.

“I am afraid,” she writes, “of everything now — of myself most of all — for Mrs. X. in trusting me has in a way put me on honor, and if I fail her again what shall I do? And yet I have the most dreadful feeling that somehow I shall fail. It seems to me as if Satan himself were mocking me, playing with me as a cat with a mouse. ‘Absurd,’ you will say, and yet it is horrible beyond words to have such fear. Do you understand? *Can* you understand without having experienced it? Mrs. X. does not, and cannot, and is only distressed by hearing about it, — and there is no one else to whom I can go. You will be confessor again and forget the note? It could not have been true, you know. Really it could not, for lots of reasons.”



The origin of the attacks of indefinable fear was thus quite intelligible: the fear of breaking her promise had passed into the secondary consciousness from which it penetrated at moments into the waking self, as an isolated phenomenon without its associated thoughts. This was easily shown by catechizing B II, who was able to give a full account of the origin of the obsession and the nature of the attacks. It will be noticed that the secondary consciousness (dissociated idea of danger) is not Sally's consciousness, but another group of subconscious states, the memory of which is retained by B II. We shall meet with numerous instances of such subconscious emotions. They correspond with the subconscious sensations in hysterical anesthesia, systematized anesthesia, etc.

Apropos of this subconscious phenomenon it is also interesting to note that in a vague way Miss Beauchamp was conscious of Sally's enjoyment of the situation. It seemed as if the emotions, pleasurable in this instance and previously aroused in the consciousness of this second personality, invaded in a mild way the field of consciousness of the primary self, B I. Miss Beauchamp stated that she had a sensation as if there were a part of her that had a feeling of pleasure when she had this fear and anxiety about breaking her promise. She was unable to give a more definite or analytical description of this psychical state, always coming back to the idea that there was something in her which seemed to enjoy it.<sup>1</sup>

The following incident was amusing, even if annoying to the victim:

Miss Beauchamp, as a protection against breaking her promise, had purposely concealed her address from one of

<sup>1</sup> If this be the correct interpretation it would seem that the primary waking self can be invaded by subconscious emotions belonging to B III as well as by those which, originally belonging to itself, become split off to form the ordinary subconsciousness.

her friends. She was therefore naturally annoyed when she received a letter from this person, and was much perplexed to know how her address, which was a new one, could have become known. But she was not astonished, because, as she said, "Jones always does know everything." After discussing this matter with me awhile and just as she was going out of the door, she changed to Sally, who began at once, most amusingly and with much seriousness, to mimic Miss Beauchamp. "I can't possibly imagine how Jones could know; it is most annoying," she repeated, and went on, using the exact words just used by Miss Beauchamp, and mimicking the tone of her voice and her manner. Sally of course was the culprit, and, as she confessed, had written Jones, giving him full information. That Sally, as usual, enjoyed Miss Beauchamp's anxiety about all these things, and was absolutely without mercy for her, goes without saying.

Sally's increasing escapades and interference with Miss Beauchamp's life and peace of mind were becoming a serious matter, and it was absolutely essential Sally should be controlled. But it was one thing to vote the suppression of the culprit and another to do it. Threats, scoldings, personal appeals to her loyalty, and hypnotism were the most effective measures, and each was used in turn, but no method produced more than temporary results.

First, the secret of her plans or past doings had to be discovered. This was no easy matter, though sometimes one could extract from her the details of an intended escape, for, childlike, she was pretty sure to betray herself by a guilty expression or gesture of some kind; and then carefully worded questions, or threats of punishment or of interference, would bring out the whole. Sometimes, when the circumstances were serious, it was necessary to put her upon a sort of hypnotic rack and elicit the information by torture, a form of inquisition which perhaps

could only be justified by the end, — Miss Beauchamp's moral peace. One day, for instance, when asked whether she had made any more secret engagements, she admitted that she had, but refused to tell more because I would stop her fun. Remonstrances proved vain, so I told her she would be compelled by other means to submit. Putting my finger to her forehead, I made her believe I had the power of exorcism. The effect was remarkable. She shrank from me much as the conventional Mephistopheles of the stage shrinks from the cross on the handle of the sword, at the same time complaining that it made a "terrible" painful sensation run through her body. This was a feeling of coldness<sup>1</sup> so intense that from its very painfulness it paralyzed her will and reduced her power of resistance. She feared it more than anything that could be done to her. Still she doggedly persisted in refusing either to reveal the secret of her engagement or to promise to break it. In spite of the pain, shrinking and crouching upon her knees, she fought on for a long time. Finally, unable to endure it longer, she yielded and confessed the details of her intended escapade. But even then her complaint was long that her fun had been spoiled, and she sought to make it a condition of surrender that nothing should be done for Miss Beauchamp, who in Sally's vocabulary was a "chump." Nevertheless the rack had brought confession.

But to control Sally, besides threats and scoldings which were sometimes effective, pleading and appeals to her innate kindness and regard for others often won her, — with one exception: no request made on behalf of Miss Beauchamp had the slightest effect. On this point she was implacable. But what good were her promises be-

<sup>1</sup> I had often used as a suggestion to suppress Sally that she "should be dead." It is probable, therefore, that this feeling of coldness arose by association with the idea of death, or a corpse. After a time it ceased to be felt.

yond a few days? She could not keep them, and always said so frankly.

Here is a letter from Sally. I give it as a specimen of her frivolity after a stern moral lecture :

“Know all men by these presents that I, Sally, being of sound mind and in full possession of all my senses, do hereby most solemnly promise to love, honor, and obey Morton Prince, M. D., situate in the city of Boston, state of Massachusetts, from this time forth, *toujours*. Amen, amen, amen.

“*Toujours* is French, you know.”

Sally had been guilty of unusual offence. Miss Beauchamp had been put to the mortification of learning that in a trance she had borrowed a large sum of money, had given forty dollars to a beggar, and then, to cap the climax, had lost a treasured watch. The latter, as I learned, Sally had pulled to pieces, — “It would be such fun to see if she could take the works out,” — and then, finding she was no watchmaker, she had hidden the pieces.

Plainly the time had come to apply the disagreeable but drastic measure of hypnotism.

So Sally was condemned. Here are two specimen applications of the punishment: She was rebellious and declared war. The contest began. Again I reproduced the cold feeling. She fought to counteract my influence and the suggestions by giving to herself counter-suggestions muttered under her breath: “I won’t be hypnotized. I can open my eyes. I can speak,” and so on, opposing every suggestion of mine by one of her own. Against the cold feeling she struggled valiantly. I pretended to etherize her with mock ether. She coughed and choked and sputtered as if it were real. “From this time forth,” I commanded, “you shall be dead to the world. You shall never again have power to influence or to molest Miss Beauchamp. Your will power is lost. You shall go back

to where you came from," etc., etc. I paralyzed her tongue, her limbs, her will power. But from moment to moment she would struggle and mutter, as well as she could with the little control left over her tongue, that she would not die, would not disappear, etc. Finally, after half an hour, she became lethargic and passive, and the final therapeutic suggestions both for Miss Beauchamp and herself were given.

The effect lasted — just four days! During this time Sally was suppressed, or as she afterwards used to express it, she had gone back to where she came from; Miss Beauchamp was herself, well and happy. Then Sally broke loose again. My notes four days later read: "Hypnotized. Same thing repeated as on Monday; same fight; same rebelliousness; same suggestions." And so it became apparent that the effect of hypnotizing Sally was not lasting.

Psychologically and therapeutically it was interesting to discover that the effect of suggestions to Sally hypnotized was twofold. First, such suggestions influenced Sally herself. She found it difficult to influence her waking consciousness, to change Miss Beauchamp to herself, to write letters, to play pranks. In fact, Sally was to a large extent "squeezed" out of existence. Second, and more interesting psychologically, suggestions to Sally influenced the waking self the same as if given to B II. This showed a relationship between the two groups of conscious states (personalities) in spite of their apparent disunion. But it was not at all clear what that relationship was. By suggestions to Sally in hypnosis, neurasthenic symptoms, insomnia, and what not, could be made to disappear in the twinkling of an eye, just as when given to B II; but unfortunately, as an effect of the anxiety induced by Sally's pranks, they would reappear almost in another twinkling.

The following letter from Miss Beauchamp expresses her attitude of mind toward her trouble:

“ Please forgive me for troubling you with this note. You need not answer it. I write only because I am tired and discouraged and full of all sorts of fancies which writing may dispel. And then too I do want to talk to you. I wish I had told you simply and frankly this afternoon just why I wanted information. It would have been so much easier for you and there was no earthly reason for not telling you. Jones has been discussing various matters lately, as you doubtless know from your reference to Dr. G., and among other things — perhaps you know this too — he told me that just so long as I continued to be in thought, word, and deed the child<sup>1</sup> that I was ten years ago, just so long would it be hard for him and dangerous for myself. Do you understand better now? And do you see why I want to know everything that you have patience to tell me? everything that other people know. It is all horribly puzzling . . . ”

But even if hypnotizing Sally was only temporary in its results it would have proved a powerful influence in treating the case, had it not been that Sally on her part made a discovery which was worth two of mine. She found that though I could hypnotize her I could not wake up Miss Beauchamp unless she (Sally) chose to let me: that is to say, even in hypnosis Sally had sufficient control left to thwart the command that she should change to B I and wake up. Here it may be added that Sally, after waking as herself, does not have amnesia for her own hypnotic state. She remembers everything said and done to her while hypnotized. She could therefore plan in anticipation of the attack against her in hypnosis, and as long as she resisted she could not be changed to B I. At every attempt to do this Sally would wake from hypnosis, and instead of obtaining Miss Beauchamp I would have Sally, who would insist upon remaining. Suggestions that she should like

<sup>1</sup> Apparently referring to her conduct as Sally, for which Miss B. got the credit. The division of personality was not understood or recognized by her friends.

Miss Beauchamp, and other suggestions intended to have a moral influence, were resisted and were without result. "I hate her," she would answer. Sally's good-will and co-operation became essential. This obtained, all was easy: Miss Beauchamp would wake up in good spirits, light-hearted, and physically without ailment.

The following scene is an illustration of the pass to which we had come. It also exhibits the other side of Sally's character, — a soft, kindly side, to which one could always appeal with success, provided it was not in behalf of Miss Beauchamp. It was this side too which was seen when we treated Sally as the personality she claimed to be, — the equal of her waking self.

It will be remembered that Miss Beauchamp had lost her Christmas Day in consequence of having changed to Sally. After Sally had given me her side of the story I told her she must let Miss Beauchamp wake up, but this she had no intention of doing. The flag of rebellion was hoisted at once, and to all my urging she would only reply in a prevaricating way, "I am awake." Finding arguments of no avail I hypnotized her against her will, making her feel, as usual, icy cold. She remonstrated and struggled with considerable vigor against this hypnotic effect, repeating, "I won't, I won't. I won't be dead," etc., etc. Finding myself baffled, I made her inhale from a mock bottle of ether, which in the hypnotic state she smelled; she coughed and breathed as if she were being suffocated. Nevertheless every time I suggested that B I should wake up, Sally would appear instead. Her mental resistance was so strong that it was finally necessary to give up this method and to take another tone. I pretended to be very much hurt by her conduct, and to be discouraged and sorry. I drew a picture of the result of her behavior, — how it had ruined the afternoon. I told her of a very ill patient whom I had been unable to visit, and who was

at the moment suffering and without a physician. In fact, I played the sympathetic act, putting on a sorrowful expression as one might with a child whose conduct one wished to reprove. Sally seemed very much affected. All the joyousness went out of her face and she appeared much disturbed by the picture I drew of the consequences of her conduct and of the trouble which she was causing other people. Then I told her that if she really were sorry, as she professed, she could make amends by letting B I wake up. But at this suggestion her manner changed in an instant to resentment. Finally, as a compromise she said that if I would promise never again to let Miss Beauchamp come to see me, and would have nothing to do with her, she would let her be waked up. Her jealousy of Miss Beauchamp was easily detected, revealing itself as the secret of her uncompromising persistency in annoying her. She did not hesitate to say as usual that she hated Miss Beauchamp, giving in explanation the usual answers; that Miss B. was always interested in books and stupid things of that kind, was foolish, did foolish things, and so on. The motive of jealousy was plain. Of course this offer of Sally's was refused. An hour had already been consumed in fruitless effort, but it was not until after another hour of moral urging in which the evil of her ways was still further emphasized that she was ready to make the concession. The picture of the trouble and unhappiness she caused other people, which I drew for her with a melodramatic hand, induced in her a real regret, and a real sorrow. But when it came to the question of Miss Beauchamp she was still implacable. It was only out of consideration for others that she finally acquiesced. Then her promise was given that every time Miss Beauchamp went into a trance she (Sally) would immediately, on the moment, wake her up; and that she would do this for the next month.

Sally pleaded that she had "just as much right to live."



as had Miss Beauchamp; that she "enjoyed life just as much" as her other self, and complained bitterly of the dull time she had when she could not get out of her shell. Almost piteously she pleaded, "Why can't I live as well as she? I have got just as much right to live as she has." To her it was a question which should die and which should live. She never could be made to recognize the identity of the two personalities.

It must not be thought that Miss Beauchamp was always ill or in dire distress. The events and scenes I have described were episodes in a life that was like a river which sometimes runs smoothly and sometimes is troubled by rapids and whirlpools. Unless Sally was particularly aggressive, Miss Beauchamp could always count upon three or four days, and occasionally upon a week of peace of mind and good physical health, after receiving therapeutic suggestions. Then there would be three or four days of annoying interference from Sally, to be put an end to in turn by therapeutic suggestion. To see Miss Beauchamp enter the consulting room weary, worn, depressed, hopelessness written upon her face and expressed in every tone of her voice, and then to see her depart with a light step, every trace of weariness gone, and the vigor of hope in her heart, — well, to see her go away so transformed by a few therapeutic suggestions amply repaid all the care and time this strange case exacted.

## CHAPTER IX

### SALLY AS A SUBCONSCIOUS AND AS AN ALTERNATING PERSONALITY

**W**HAT is Sally? What sort of a consciousness is this personality? And what relationship exists between her consciousness and the waking B I?

An answer to this problem cannot be given until many more facts in the psychology of this complex case are studied. On the basis, however, of the facts thus far adduced we are warranted in definitely drawing certain conclusions:

In the first place, Sally is a distinct personality in the sense of having a character, trains of thought, memories, perceptions, acquisitions, and mental acquirements, different from those of B I.

Secondly: She is an alternating personality in that during the times when the primary self has vanished Sally is for the time being the whole conscious personality, having taken the place of the other. As an alternating personality so much of the whole field of consciousness as persists belongs to her and there is no other self. At such times B I does not become a subconsciousness to Sally but as a personality is wiped out.

Thirdly: Sally does not simply alternate with B I. There are times when Sally manifests herself as a concomitant extra-consciousness, concomitant with the primary personality, B I and also B II. A greater or less number of the groups of conscious states which make up her personality, her perceptions, her thoughts, and her will, coexist with those of B I. In other words, there is a

doubling of the personality. It is convenient to speak of this second group, whether large or small, as Sally, whether it is the whole of Sally or not. Sally may therefore be termed a *co-consciousness*, or a subconsciousness.

The evidence for coexistence is found in the many manifestations already recited of another consciousness while Miss Beauchamp has been present. The phenomena of automatic movements, aboulia, obsessions, imperative impulses, and the conflict between the two wills, may be particularly mentioned. Even more conclusive are the phenomena of "automatic writing" and speech which were later frequently observed. Proofs of this doubling of consciousness will be found running through this study.

A curious fact, difficult to interpret satisfactorily excepting on the theory of the persistence of "Sally" as a subconscious self, is that on several occasions when Miss Beauchamp was delirious the evidence indicated the coincident presence of Sally as a perfectly sane subconsciousness.

Fourthly: It does not follow that the extent of Sally's mind as a subconscious self is coextensive with her mind as an alternating self.

One of the most interesting problems, and one which has an important bearing upon that of the limits of subconscious life, is whether or not Sally, when not present as an alternating self, is always in existence as a subconscious self. Sally maintains that she is; that (subconsciously) she knows everything Miss Beauchamp (and B II) does at the time she does it, — knows what she thinks, hears what she says, reads what she writes, and sees what she does; that she knows all this as a separate co-self, and that her knowledge does not come to her afterwards, when an alternating self, in the form of memory. We shall soon see that the same claim is made for a persistent existence during the presence of B IV.

This is a very broad claim for subconscious life, even when pathological. It is not, however, very much more extreme than the interpretation which is connoted by the published description of some reported cases.<sup>1</sup>

If we confine ourselves in the case of Sally to the subconscious phenomena which are open to objective investigation and have been actually observed, we shall find that they are subject to two interpretations, namely:

(A.) Sally may subconsciously come to life only at the moment when the automatic phenomena are manifested. After the cessation of the automatism the subconscious self may subside as any idea or feeling may subside. In this case the sub-self would have only a series of spasmodic existences, each of which would be of only relatively momentary duration. Her knowledge of Miss Beauchamp's life would be acquired almost entirely through memory when she becomes an alternating self; just as a hypnotic self remembers the waking state. Sally's belief (the sincerity of which is beyond question) in her own continuous existence must, under this interpretation, be an illusion of memory.

(B.) Sally, or some of her mental processes, may have a continuous existence during the whole of Miss Beauchamp's (and B IV's) life, or during certain periods, for example, during a period of delirium. In this case the automatic manifestations would be merely ebullitions in the mental life of a persistent subconscious self. A subconsciousness of this extent would, however, not necessarily be more than an exaggeration of that which is shown by the subconscious solution of arithmetical problems.

Besides the objective evidence, the introspective testimony of Sally ought to be at least weighed.

A consideration of these two interpretations will be postponed until we have all the data of the case before us. It

<sup>1</sup> Compare Janet's account of Mme. B.; *Rev. Philosoph.*, March, 1888.

should, however, be insisted upon that the first, the more conservative of the two, should be held until it can be shown to be inadequate. We should be on our guard against hastily ascribing to subconscious activity and doubling of consciousness phenomena which may quite as well be explained as *alternations* of mental states. Much of the automatic activity, like writing, speaking, etc., which in well known reported cases has been interpreted as subconscious phenomena, has been, in my judgment, in large part at least, merely exhibitions of alternations of consciousness. The subject goes into a dreamy state in which little or nothing is left of the primary consciousness, while a newly organized self comes to the front and gives the exhibition. Some of the automatic action exhibited by Miss Beauchamp was of this character. In such instances Sally, though apparently acting subconsciously, was practically an alternating self. The internal as well as the external evidence must often be weighed in determining the reality of co-conscious activity.

If the phraseology of the text appears to definitely postulate a *continuous* subconscious self, I would have it borne in mind that for the present we are mainly concerned with the description of the phenomena, rather than their interpretation. Whatever interpretation we shall be obliged finally to adopt, both B I and B IV were compelled by the exigencies of their "possession" to conduct themselves as if their "demon" were always "inside," a spectator of their lives.

There are certain other peculiarities of Sally which ought to be stated now:

Sally has a peculiar form of *anesthesia*. With her eyes closed she can feel nothing. The tactile, pain, thermic, and muscular senses are involved. You may stroke, prick, or burn any part of her skin and she does not feel it. You may place a limb in any posture without her being able to recognize the position which has been assumed. But let her open her eyes and look at what you are doing, let her

join the visual sense with the tactile or other senses, and the lost sensations at once return. The association of visual perceptions with these sensations brings the latter into the field of her personal consciousness. The same thing is true of auditory perceptions. If Sally hears a sound associated with an object, she can feel the object. For instance, place a bunch of keys in her hand and she does not know what she holds. Now jingle the keys and she can at once feel them, as is shown by her being able to recognize the different parts of their forms.

*Sensation may also be restored by suggestion.* But the restoration is only temporary, lasting for a few hours or for the day. I used frequently to restore sensation in this way for Sally. Seeing how easily it was done, Sally took the tip and every morning, when at the height of her career, used to make the suggestions to herself, using my language. She would thus secure to herself the advantage of sensory perceptions. It was possible to suggest, to a limited extent at least, painful sensations, that is, the feeling of intense, painful coldness. This was utilized in controlling her. No experiments were made in producing other forms of pain.

Curiously, Sally does not have, as we should expect, limitation of the field of vision unless she is "squeezed"; then there is moderate limitation. Nor is there impairment of the special senses.

This peculiar anesthesia is not as bizarre as may appear at first sight, although I do not happen to have run across any references to it in the literature showing that it has been previously observed. Yet it is analogous to a form of hysterical blindness when monocular. Such a subject, as pointed out and proved by Parinaud, Pitres, Charcot, and other French observers, as well as by myself,<sup>1</sup> cannot

<sup>1</sup> Hysterical Monocular Amblyopia. Amer. Jour. Med. Sciences, February, 1897.

see with the blind eye, if the other is closed. But as soon as the opposite eye is opened, sight returns at once to the affected eye, that is, as soon as the images of the affected eye are associated with those of the sound eye. (The recognition of this peculiarity of the amblyopia of some hysterics is important, as such subjects are often charged with malingering.) Another analogous phenomenon is what is known as Laségue's Symptom. A hysteric who with eyes closed has muscular weakness (or paresis) of a degree which will prevent him from recording more than a few degrees on the dynamometer, will, if his eyes are open (and he has visual perception of his hand), have an increase of power of grasp that will record 80° or 90°. The association of the visual images has the effect of restoring to the personal consciousness the kinesthetic images necessary for muscular movements.

The explanation of such phenomena at present is difficult, if not impossible. It is undoubtedly to be found in the reintegration of the field of consciousness, but I am inclined to the view that the data at hand point to an integration along physiological lines, — that is, the neuron systems, rather than along the lines of association of ideas.

Sally's anesthesia extends to the somatic feelings. She is never hungry or thirsty. If she eats she does so as a matter of form or social requirement. There is also an entire absence of bodily discomforts. This anesthesia probably explains in large part Sally's *freedom from ill health*. She does not know the meaning of fatigue, of pain, of ill health. She always is well. It is probably, in part at least, in consequence of this anesthesia that Sally does not share the pain or other physical ailments of Miss Beauchamp, or any of the personalities. Let Miss Beauchamp be suffering from abdominal pain, or headache, or physical exhaustion, and let her change to Sally and at

once all these symptoms disappear. Sally knows of the symptoms of the other personalities only through their thoughts or their actions. She does not feel the symptoms themselves. The same is true of the sense of muscular fatigue. Sally can walk miles without being conscious of the physiological effect. Curiously enough, however, Miss Beauchamp may afterwards suffer from the fatigue effects of Sally's exertions.

What is true of Sally in these respects as an alternating personality is also true of her as a subconsciousness. *Subconsciously, Sally is always anesthetic.* If Miss Beauchamp's eyes are closed and any portion of the skin is touched or pricked, or if a limb is placed in any posture, subconscious Sally is unconscious of the tactile pain or muscular sensations, although the other personalities are not anesthetic, but perceive each sensation perfectly.

It was found possible to take advantage of this fact and by pressure upon certain so-called hypnogenetic points on B I, B II, or B III, to produce suggestive effects in one of the other personalities or hypnotic states without Sally's being able to discover the procedure employed. In one epoch of this study I was in this way able to produce therapeutic results without Sally's being able, because of her ignorance, to thwart my efforts as she was desirous of doing.

Sally's knowledge of Miss Beauchamp's thoughts shows certain curious paradoxical peculiarities. Although she knows Miss Beauchamp's thoughts at any given moment *she has not Miss Beauchamp's culture.* This is true whether Sally is a subconsciousness or an alternating personality. She does not know French or other foreign languages, nor can she write shorthand. In brief, she has little of the Primary Self's education, but she reads, writes, and speaks English well. Some unusual words, like "psychology," bother her, and sometimes she insists,



in a childlike way, upon the prerogative of coining words of her own.

Here, again, it was found possible to take advantage of this curious ignorance of the subconscious Sally, to communicate with Miss Beauchamp without betraying what was said to Sally. By conversing in French with Miss Beauchamp it was possible to communicate information which it was desirable that Sally should not have. This often brought retaliation from the latter. Also Miss Beauchamp, to conceal her thoughts from her other self, has been in the habit of writing her diary in shorthand.

It is not easy to give a psychological explanation of this difference in the conscious assimilation of Miss Beauchamp's intellectual processes by this secondary consciousness, according as to whether those processes are made up of thoughts of the moment or of memories of what passes under the head of learned acquisitions. It would seem that it is the memory of those intellectual processes which were formed by laborious attention and repetition which are not synthesized with Sally's consciousness, — in other words, the memory of certain educational mental processes. Yet Sally can write and has an elementary education. On the other hand, the memory of Miss Beauchamp's past experiences, which might be in a general way classified as social, or the experiences of conduct, are all synthesized with Sally's mind. Sally's memory for these experiences is probably better than that of Miss Beauchamp. Can these peculiarities depend upon the fact that the subconscious Sally pays little or no attention to matters which occupy Miss Beauchamp's mind as objects of study? Can it be possible that Sally had really become well differentiated as a secondary consciousness at the time when Miss Beauchamp pursued her school and college education, and was able by voluntary effort to neglect those thoughts which were occupied with study? If Sally's autobiography can be

accepted as evidence, there is something to be said in favor of such a hypothesis. Sally herself has rather strongly intimated it and there was some evidence of it to be found in the experiences of Miss Beauchamp and Sally when the former was studying shorthand during the period of this study. Yet I think there is a profounder reason to be found in an intellectual limitation of the capacity for synthesis. If Sally is directed to concentrate her mind on a mathematical problem, or other similar subject, Sally tends to change to Miss Beauchamp. That is to say, by synthesizing Miss Beauchamp's knowledge with that of Sally, the latter disappears, and the main personality becomes dominant.

Of course it is manifest that one of the most marked peculiarities of Sally's personality is its *childlike immaturity*. Sally is a child. This suggested the idea that Sally might be a reversion to an early period of Miss Beauchamp's life. It is a well-known fact that in hypnotic experiments certain states may be artificially produced in which the subject is found to have reverted to a particular period of his life. A subject named M—, for instance, studied by Dr. Sidis, Dr. Linenthal, and myself, was made to revert to a period in his life when he was sixteen years of age. He then spontaneously, uninfluenced by suggestion, lost his knowledge of the English language and spoke his own native dialect, Russo-German, which he spoke when a boy. The same phenomenon has been observed in multiple personality. The classical case of Louis Vivé in several of his personalities reverted to corresponding epochs in his life, and in each personality he was afflicted with the same paralytic infirmity with which he was afflicted at the time: in one case hemiplegia, in another, paraplegia, etc. A moment's consideration, however, will disprove such a theory if applied to Sally. In the first place her memory is not limited to any particular epoch,

but she has a continuous memory of her whole life. Such necessarily could not be the case in the reversion type of personality. In the second place, as an alternating personality she remembers numerous previously subconscious states, showing a distinctly different type of dissociation.

With this brief description of Sally's personality it would seem advisable to dismiss further discussion of her psychology until we come to discuss the theory of the case as a whole, and the theory of the secondary consciousness. It may be said simply in the way of summary that *Sally is a dissociated group of conscious states*. These are probably entirely pathological and have no analogy in normal life. I am unable to see that, unlike some other subconscious states shown to exist in this case, Sally, as a subconsciousness fulfils any useful function in the mental economy.

Sally *claims never to sleep*, but it is very likely that this is an illusion on her part. She claims to know the dreams of Miss Beauchamp to the minutest detail, including those dreams which are not remembered on waking, and the external agencies, such as sounds in the street, which give rise to them. By comparing Sally's statements with those of Miss Beauchamp it is possible to verify Sally's claim in regard to the dreams which Miss Beauchamp remembers, but, of course, these dreams Sally would be expected to know, whether she slept or not. More interesting is the fact that this subconscious personality insists that there are many other dreams which Miss Beauchamp does not remember on waking, and which she, Sally, claims to be conscious of and remember. These dreams are more extensive than those that are remembered. It has not been found possible to verify this testimony which must be judged on its intrinsic evidence.

Most curious is Sally's absolute *ignorance of time*. She cannot compute it. A day, a week, a month are almost the same to her. Things happened "a short time ago,"

or "a long time ago," in her calendar. But even these expressions do not connote the same ideas to her as to the rest of us. One year is the same as ten years; ten seconds as ten minutes. Ask her to guess a minute, and she is as likely to call time at the end of ten seconds as five minutes. It would seem as if this absolute inability to measure time might, if experimentally studied, throw some light on our psychological time perceptions. It would seem as if time could not be entirely measured by the memory of the succession of events, for Sally experiences events as well as any one else. She does not know her own age.

Can there be a time sense? If not, what prevents Sally from estimating time?

Sally is also suggestible. It is possible to hypnotize her, although she has no amnesia on awaking, and to produce various phenomena of suggestion; to produce closure of the lids, to make her blind, deaf, and dumb. Further, through suggestions to this self, it is possible to affect the waking self; to produce sleep, relieve uncomfortable symptoms, etc.

One of the most difficult and at the same time interesting problems offered by Sally is the extent of her mind as a subconsciousness. When Sally disappears as an alternating personality and becomes subconscious, does her mind in the transformation lose something of its faculties and dwindle in the range of its mental processes? This would mean conversely that, when Sally emerges from her subconscious position and becomes an alternating personality, by the very process she robs the primary consciousness of a part of its mind, and to that extent acquires a wider field of consciousness herself.

This question is difficult to answer in its entirety, as, for reasons which will be explained when we inquire into the problem of the subconscious,<sup>1</sup> it is not open to experi-

<sup>1</sup> Vol. II.

mental methods of investigation. We have to rely chiefly upon the evidence derived from the spontaneous phenomena, such as will be described in the further course of this study. I will here merely point out that there is evidence of the curtailment, in one respect, at least, of Sally's mind as a subconsciousness, namely: Sally does not possess, save under exceptional conditions, the kinesthetic images of muscular movements. This is only another way of saying that Sally does not possess the use of the limbs and body nor the faculty of speech. The primary consciousness alone has control of the motor centres of the brain. It is only under exceptional conditions or when Sally becomes an alternating personality that these centres become associated with her consciousness. It is possible, therefore, if not probable, that there is some curtailment of subconscious Sally's mind in other directions. Evidence of this is seen when Sally becomes "squeezed." Then she constantly complains that she is limited in the freedom of her actions. This is shown by the difficulty that she has at such times in writing, either as a subconsciousness, or as an alternating personality. Her writing loses its freedom, it becomes crabbed, cramped, and, it may be, illegible, until, if the "squeezing" process is carried further, she is obliged to resort to printing (Appendix Q.) to express her thoughts, and may not be able to do even that. At such times, as an alternating self, she has been known to be reduced to cutting printed words and letters from the newspapers, and by pasting them together to transmit her messages. And yet the content of the various subconscious phenomena which have been frequently manifested by Sally indicates a large field of conscious thought. We shall be in a better position to consider the range of the subconsciousness after the study of the phenomena is completed.

## CHAPTER X

### SALLY TORMENTS MISS BEAUCHAMP WITH PRACTICAL JOKES

ONE day in April Miss Beauchamp reported the mysterious disappearance of some money. In the early days of her trials I had on several occasions discovered for her the whereabouts of lost<sup>1</sup> articles, either by hypnotizing her and questioning B II and Sally, or by producing a "crystal" vision. Miss Beauchamp now applied for aid in recovering her money. She was sorely worried. To be constantly plagued by Sally as she had been was bad enough, but to begin now losing money was a matter of anxiety. It goes without saying that whenever anything went wrong suspicion always at once fell on the subconscious "devil," but in this case we did her satanic ladyship a gross injustice.

On hypnotizing Miss Beauchamp she became, not Sally, as had been the case of late, but B II, who had not been seen for a long time. Presently the old struggle of the hands began. In spite of B II's resistance, the hands attempted to rub her eyes as they used to do before Sally's advent as a personality. Suspecting that Sally was at work, I held the hands, being obliged to use considerable force, and gave commands that the hypnotic B II should keep her hands still, etc. In reply to this B II kept repeating that she could n't help it, that she did not know what she was doing, that she wanted to rub her eyes, etc., etc.

<sup>1</sup> That is, when absentmindedly mislaid, or when taken by Sally.

The battle between B II and the hands, as I watched it, gave the impression of severance of control on the part of the former, who did not seem to be clearly conscious of what she was doing. It was as if some invisible stranger had hold of her arms and was trying to wrest them from my grasp and to use them regardless of the owner, who also endeavored to keep control and to prevent their being used. This struggle went on for some ten minutes: at one time B II would obtain control and the hands would become quiet; then the invisible stranger would return to the attack and the struggle would be renewed; then the hands would gain the ascendancy and I would be obliged to come to B II's assistance and hold them by main force. Finally, I let go to see what would happen. Immediately the hands began to rub her eyes, and then, as I suspected would be the case, her eyes almost immediately opened and Sally appeared laughing.

The battle was only another of many instances of the second consciousness acting coincidentally with the first; the two consciousnesses willing, acting, and thinking along separate and opposed lines at one and the same time. An automatic phenomenon of this kind requires to be seen to be appreciated. Several instances of automatisms actually observed have already been given in a preceding chapter. They were very common and were not confined to movements of the limbs. Over and over again I have witnessed such things as this: While impressing on B I or B II that she was or was not to do something contrary to what was known to be Sally's wish, suddenly out of the depths, so to speak, would come like an explosion a deep, "I won't," or "I will." The voice would be changed in tone to a bass note and be accompanied by a momentary expression on her face, not easy to describe or pleasant to look upon. The voice was Jacob's voice, but the hands were the hands of Esau. After this Miss Beauchamp, all

oblivious<sup>1</sup> of the incident, would speak naturally, as if nothing had happened. Or the automatism would take a sensory form, that of an auditory illusion. The plain words of my command would be perverted and be heard by Miss Beauchamp as illusory words having the contrary meaning. Thus Miss Beauchamp would understand me to say the opposite of what I really said. This could be brought out by having Miss Beauchamp repeat what she believed had been said to her.

One of the most curious of these automatisms was the flashing of Sally's facial expression — revealing her presence and amusement — through Miss Beauchamp's sadness. This is the way it would happen: I would be talking with Miss Beauchamp when she was in a state of depression, her face weary and sad. Suddenly the gleeful expression of Sally would flash over it momentarily, as if Sally's joy at the scene was too intense to be hidden. These were some of the ways by which Sally would seek to circumvent every attempt at control, and sometimes, to my chagrin, she succeeded.

To return to the incident just described: Pretending ignorance of the reason for B II's rubbing her eyes, I asked Sally if she knew why B II had done it, thus assuming that it had been B II. Sally immediately replied, "I did it."

I questioned her statement, as was my habit in order to draw her out, denied her power, and demanded that she explain how she could do it when she was not present.

Her reply was, "I am always present. I can make her do things: I have told you that over and over again, lots of times. I wanted to get her eyes open. If her eyes

<sup>1</sup> The primary consciousness, it will be noted, was unconscious of having spoken: the phenomenon thus differs from that other type of automatic speech already described (telling lies), where the subject knows what is said. The difference depends on the extent of dissociation of consciousness.



were open she would not be here; I should be here. You told her I should not come any more, and I wanted to come." (Laughs.)<sup>1</sup>

The search for the lost money led to a hypnotic vision, according to which the money had dropped, unnoticed by Miss Beauchamp, out of a book which she was reading. The money had fallen upon the window-sill, and had been blown out by a draught upon the deep ledge of the coping outside the window in the mansard roof. There was no opportunity to verify the vision; in fact, it scarcely seemed possible to do so. Whether it was true or not, therefore, cannot be stated, if the testimony of Sally (given in part below) be disregarded. Nevertheless the vision had serious consequences for Miss Beauchamp. Such careless absent-mindedness was not to be condoned, was the judgment of her subconscious guardian. After learning the content of the vision, Miss Beauchamp returned home to hunt for the money, if by chance it had lodged in the gutter. (Miss Beauchamp had frequently found in this gutter lost articles which had fallen off the window-sill.) On this occasion it was not she who found the lost money, if Sally is to be believed, for a day or two later the following was received from Sally:

"It is really a very long time since I wrote you, is n't it? and lots of things have been happening that I want to tell you about, so you won't be cross with me for sending you this? She does n't even read my letters now, so that it is only exasperating writing her, and I must talk to some one, you know. Was n't it curious, part<sup>2</sup> of the money was really there in the gutter, all curled up in a disreputable heap; and I rescued it and have hidden it where she can never, never find it, for she is not responsible, you know, and I am going to take charge of all

<sup>1</sup> In hypnosis the suggestion had been given that B I should not go into trances any more.

<sup>2</sup> Sally found, as she claimed later, a \$2 bill and two \$1 bills; originally there was \$7 in all, so that \$3 must have blown away.

such things and allow her only ten cents to amuse herself with. But she does n't care apparently for anything I may do, and it is trying. Won't you speak severely to her, Dr. Prince, please? I am sure it would do her no end of good. I do want you to. And she has destroyed all those pictures<sup>1</sup> of you — every one — which were n't really hers anyway, and I miss them. She had much better have destroyed the absurd books that she buries herself in — they are full of such 'stuff.' I would send you the slips if I were not sure of being sat upon for playing tricks. Hoping this may find you neither tired nor sorry, but very happy, I remain,"

"P. S. I don't like [the name] Sally, for it is very childish, but it does n't matter. She swears too, and is degenerating awfully. Is that psychological?"

Miss Beauchamp had indeed cause to repent bitterly of her absentmindedness and lack of care, for she was punished by being put upon an allowance which was doled out to her in amounts of from five to ten cents a day. It was about twenty-four hours after returning home that she received a note from Sally with the first instalment. The note said, in substance, that she could have ten cents to amuse herself with, but no more, and that henceforth the writer was going to take charge of her finances. The rest of her money was thereupon confiscated and a deluge of letters followed, reminding Miss Beauchamp in no gentle way, that she was not fitted to take care of money, that she was an incapable, and declaring that she was to be put upon an allowance. The sum, however, was never fixed. Sometimes it proved to be five cents, and sometimes two cents. At other times she would find ten cents lying on a sheet of paper with a message accompanying it. Sometimes it would be rolled up in a package or in an envelope, and left somewhere about the room. If she refused to open or read the letters, a piece of paper, on which

<sup>1</sup> Some drawings (caricatures?) of Sally's.

a saucy message was written, would be pinned up on the wall where she could not help seeing it.

No amount of pleading would induce Sally to allow Miss Beauchamp to have more money than her allowance. Thus was Miss Beauchamp corrected for her carelessness.

But this was only a small part of the torment to which she was subjected. Her punishment did not end here. Her postage stamps were taken, and with her small allowance she did not have money enough to buy them or to pay street-car fares. So, in the want of the latter, she walked; and as for letters, when she wrote one, she was compelled by her tyrant to place it on the table for approval. If it was approved, she found it stamped and was allowed to post it; if not approved, it did not go, and that was the end of it. "She writes too many letters," said Sally. "She sha'n't write, excepting to people whom I choose, and she sha'n't have any money excepting what I give her."

Miss Beauchamp has a nervous antipathy to spiders, snakes, and toads; she abhors them to a degree that contact with them throws her into a condition of terror. One day she found in her room a small box neatly tied up, as if it were a present for herself. On opening it six spiders ran out. "She screamed," said Sally, "when she opened the box, and they ran out all over the room." It turned out that Sally had gone into the country and gathered these spiders as a treat for Miss Beauchamp. On other occasions, there is reason to believe that Sally provided snakes.

One of Miss Beauchamp's constant trials was to find a piece of worsted work she was making unravelled as fast as she made it. She had been asked by a very dear friend (Mrs. X.) to make a baby's blanket. Her heart was in the work and she was anxious to finish it. She had worked at it for months, but often complained to me that whenever it neared completion she would find it almost wholly unrav-

elled. Then, like Sisyphus, she would have to begin her task all over again. Finally, when at last the blanket was finished and ready to send, the climax came. Sally pulled the whole of it to pieces, and drawing out the yarn wound it round about the furniture, carrying it from picture to picture, back to the different articles of furniture, then round herself many times, then back to the furniture, finally hiding the ends somewhere in the bed. Then Sally, standing in the midst of this perfect tangle of yarn, wakened Miss Beauchamp, who came to herself in the maze. So great was the tangle that she had to cut the yarn to get out.

Another of Sally's pranks which had serious consequences to Miss Beauchamp's health was to take her on walks too long for her strength. On one occasion she went out into a suburban town (Watertown) and there took a long walk, so far beyond Miss Beauchamp's strength that it left the latter exhausted. Miss Beauchamp came to herself in this suburb, weary and helpless, unable to recognize the place, and ignorant of the way home.

One very curious phenomenon was the difference between the physical condition of Sally and that of Miss Beauchamp after a fatiguing walk of this kind. On this occasion two days later Miss Beauchamp was still extremely fatigued and worn out. Then suddenly changing in my presence to Sally, this personage appeared perfectly fresh and unaffected by the walk. Then changing back to Miss Beauchamp, the fatigue returned with the change of personality.

Sally's enjoyment at making Miss Beauchamp tell nonsensical lies has already been related, as well as the way this young scapegrace would spend the latter's money. I do not think I have mentioned how Sally took advantage of Miss Beauchamp's sense of dignity. Knowing this feeling was acute, Sally, to punish her, would make her sit

with her feet on another chair, or even on the mantelpiece. Miss Beauchamp could not take her feet down, but would have to sit there undergoing the torture of mortification. On numerous occasions (Miss Beauchamp now says "innumerable") Sally tore up many manuscript pages of her school work, the product of much labor. She used to try her best at times to prevent Miss Beauchamp's doing things the latter wanted to do; then Miss Beauchamp would feel an "irresistible impulse," as if "possessed," as she described it.

Of course, Sally, on the principle of giving a dog a bad name, got blamed for much she did not do. Naturally, when anything went wrong she was the first to be suspected. Although it amused her to make Miss Beauchamp miserable, nevertheless at times, when she went too far and Miss Beauchamp became ill from anxiety, Sally would be alarmed and would write me a letter asking for help, saying she could "not do anything with Miss Beauchamp"; and that I "really must help" her.

The above are but a small number of the practical jokes which Sally played on her other self. It would seem as if practical jokes and hazing were trials enough for one person to bear; but of all the trials which Miss Beauchamp had to undergo, I think what she minded most were the letters she received from her other self. She was deluged with letters; and if she refused to read them Sally would pin upon the wall sheets of paper with messages written thereon, and so placed that she could not help seeing them. Sally knew her sensitiveness, her keen sense of honor, as well as all her little weaknesses, and these she played upon in a highly artistic manner. Then again Sally would write letters to different people, telling all sorts of things about Miss Beauchamp's private affairs, exaggerating and distorting them beyond recognition, and even telling things not true. She would describe extraordinary and impos-

sible things she proposed to do, pretended engagements objectionable to Miss Beauchamp, — all of which was sufficient to frighten the latter out of her senses. These letters Sally had no intention of sending, but she would leave them open where they could be read by Miss Beauchamp, who, taking them seriously, would be made to feel she lived over a dynamite magazine. Sometimes, however, Sally would actually send letters which expressed her own peculiar ideas. These naturally would be extremely disagreeable to Miss Beauchamp, who would learn of them from her friends or from the letters received in reply.

Of all these letters, perhaps the most diabolical and the most troublesome for me were those in which Sally misrepresented my attitude towards Miss Beauchamp. For instance, she wrote B I that I accused her of not keeping her word and of telling untruths, and that I was so annoyed with her that I wished her never to come again for treatment. Sally's game was to prevent Miss Beauchamp's being the object of care. In spite of constant warnings not to believe Sally's statements, B I always accepted them as true. A despairing letter from her would follow, declaring her ignorance of everything she had ever done in her "lapses," and asking forgiveness for anything that was displeasing. Here is a letter from Sally to me which suggests her state of mind in relation to Miss Beauchamp :

"You are a perfectly charming correspondent — much more interesting and unconventional than Jones — and I am sure I shall enjoy writing to you no end, especially if you continue to ignore everything I tell you. Do you fancy that makes one feel snubbed and repentant? because it doesn't, the least little bit in the world. I am 'made of sterner stuff,' as the books say. The enclosed youth<sup>1</sup> I am much interested in, and hope you will appreciate his expression, which is strongly like Miss Beauchamp's during the wee sma' hours when she cannot

<sup>1</sup> An illustration cut from one of Miss Beauchamp's favorite books.

sleep. Don't show it to her on any account, for it is taken from one of her cherished books, and she might perhaps not approve."

The following are a few of the letters Miss Beauchamp received from the same correspondent. The great mass of them was destroyed, as many referred to private matters in a disagreeable way, and Miss Beauchamp felt so keenly the mortification of her acts that it was with difficulty she could be prevailed upon to show the letters.

"The enclosed with my compliments, Mistress Chris, and you will permit me to congratulate you on so successful an issue to your evening's work. After this you will hardly have need of me or of my assistance in your financial affairs. I regret not having the proverbial shilling for you, yet you are 'such a sweet child' that I know you won't murmur. Are you going to tell —— all about ——? It would be awfully nice and unconventional, and he would appreciate your confiding in him, I am sure, almost if not quite as much as Dr. Prince himself. Do tell him. I hope you may enjoy life very much indeed during these next few weeks. I am going to make it just as lively and interesting for you as I possibly can, and you know that means a great deal when I say it. Does n't your fancy conjure up all sorts of visions? You shall have all my thought and care and attention to keep you from brooding. Think of it! Your knight *sans peur* and *sans reproche* could hardly do more, however you might thrill and agonize for him. He's not exactly interested you know, as I am, and of course cannot help getting awfully tired of you. But *I sha'n't tire — not till 'stodent C. is very dead and puts a bullet through her head.'* How long will that be, do you think? Days, weeks, — not longer, surely, for you love your friends, you know, and would not cause them a moment's pain. You never did, dear, did you? You will sacrifice yourself at the earliest opportunity."

"If you do not write Nan immediately — this very day — I shall, and I give you fair warning that I shall entertain her at your expense — not a difficult thing, you know, and it would

please her immensely, I am sure. Also, I do not approve of the blue book, and shall sew up your skirt again if you read it.<sup>1</sup> Remember!"

"I have such good news for you, my dearest Chris. Just fancy, Z. knows where there is a whole colony of lovely cool, green snakes — little slippery, sliddery ones, you know — and I'm going to get them to amuse you at night and keep you from dreaming of your dear ——. Are n't you glad? But I know you're not the least little bit grateful — but you will be before we have finished our course together. Do you smart to-day, awfully? It's good for you, you know; you must always remember that, Chris, dear. I enclose a stamp for you too."

"You little wretch! What did you kill my nice spiders for? I wish they'd bitten you all over. It would have served you just exactly right for destroying things that don't belong to you. 'Soul of honor' indeed! 'How are the mighty fallen!' You were a thief to touch my pictures, and a wicked, wicked girl! You had nothing to do with them. They were all mine, and you shall wear the sack for your sins. There are more spiders, and there are caterpillars too, all squashy, if the sack is not happiness enough for you."

"It was a horribly mean advantage to take of any one, Mistress Chris, and you know it, and you shall be punished for it. I have the greatest mind in the world to send the letter directly to Dr. Prince, and then you'd see whether even for her sake he'd tolerate you. I never heard of anything so outrageous, and yet you are *proud*, yes, and *honorable*, and quite shocked at your humble servant's disregard of conventions. How I hate you for a hypocrite! But I must not spare the rod, for by it you may be saved even yet. It will be better after all than an appeal to Dr. Prince. He does" — [Remainder of letter lost.]

"How awfully amusing you are, my dear, with all your shifts and evasions; but you cannot escape me so. You are to do *just exactly what I tell you concerning Z.*, and moreover you are to

<sup>1</sup> Sally at night used to sew up Miss Beauchamp's clothes, so that in the morning, when in a hurry, she could not get into them.



do it at once. I simply won't have this nonsense about B. You *shall* love J——, always and forever, or if you don't you ought to and you shall. I will make you — just make you — you wicked, wicked girl. Do you want to be all bluggy and wear the sack again? One would certainly think so, and if it comes to it I won't deny you. You may have until evening to consider, and *then*, 'O, I'm sorry for Mrs. Bluebeard, sorry to cause her pain, but a terrible spree there's sure to be when I come back again,' if you have n't done as I told you. There is none to help you — no, not one. We all hate you. Only sometimes occasionally one pities you a little for being such an idiot and tries to help you, but it is useless. My way is better. B. is a goose, and so is ——."

These notes were enclosed in the following from Miss Beauchamp to the writer :

"I am sending you with this such of the notes as I have been able to find. There are more doubtless, scattered about, and I shall be very glad to send you those too as I come across them, if you think they would be of any interest. Sally's feeling toward me is very strong, as you know, and she does not hesitate to give expression to it both by word and deed. I have shrunk from telling you much of the 'discipline' to which you will find reference in some of the letters, and don't think it is necessary to do so even now, except, perhaps, for your fuller comprehension. The other notes referred to, I think you understand as well, or perhaps much better than I do myself. [Letter goes on to state what seem to be the principal 'grievances in Sally's mind' and then continues :] Most of the letters in which she enlarges upon this I have unfortunately destroyed, for I did not want them to fall into any one's hands. They were really dreadful. . . . One would almost swear she was bitterly jealous. Oh, Dr. Prince, save me from her, from myself, from whatever it is that is so absolutely merciless! I can bear the 'sack,' 'discipline,' anything that is physical — but not the mockery of this devil. You cannot imagine the torture I have endured in these few months — no one could.

"But this brings me to your letter [written to tell her that

Sally's message to the effect that she was to be dismissed was untrue, etc.] . . . No one has the slightest control over this devil that possesses me save you. You won't leave me to its mercy?"

The child mind in Sally's compositions is too obvious to be dwelt upon. The letters remind one of the way in which a child might upbraid her doll; and yet Sally could write kindly, sympathetic letters — childlike too — of which I have often been the recipient. She affected to Miss Beauchamp to dislike any one whom Miss Beauchamp held in esteem, and yet I knew from personal knowledge that Sally held some of these persons in equal regard. Sally and the writer were the best of friends, though she made Miss Beauchamp believe the contrary. In judging Sally, all this must be kept in mind. But Sally hated Miss Beauchamp, and the secret of her hatred was unquestionably jealousy, as Miss Beauchamp suspected. Sally frequently complained that everybody seemed to care about what was going to become of Miss Beauchamp, but nothing about her own fate. She felt hurt too that she was told she was childish and irresponsible and broke her promises, while Miss Beauchamp was treated with great respect. "Nobody cares what becomes of me," she would repeat. Then she felt her lack of mental accomplishments as compared with Miss Beauchamp. And even when made much of by friends who did not know of the split in the family, she knew that the attentions were intended for Miss Beauchamp and not for herself.

[Notebook] *April 28, 1899.* "As Sally had been tormenting Miss Beauchamp, I took occasion to upbraid her. In answer to the question why she behaved so badly, she replied, 'I hate her, and I won't give her any more money, and I won't give her any more postage stamps. I just hate her more and more!'

"'But why do you hate her? You are only hating yourself, for she is yourself.'

“‘No, she is n’t.’ [With resentment.]

“‘Yes, she is.’

“‘No, she is n’t. I won’t have it so! We are not the same person. We don’t think alike, and we don’t have the same thoughts,’ etc., etc. Her indignation increased, and she ended again with, ‘I certainly hate her. She thinks she won’t let me come [that is, into active existence as Sally]. She has been saying it all day. I made her stay awake all last night, and I will to-night, and I will every night. I am going to make a collection of other things too besides spiders. I am going to do everything I can think of, and I can think of all sorts of things when I try hard. I tried to cut off her hair the other day, but she woke up before I could do it. I think the scissors waked her up.’

“‘You will cut off your own hair; it is your hair.’

[Laughing.] “‘I don’t care. She will look a guy — just like one of those monkeys. I don’t care how I look.’

“‘A few minutes later, after discussing the way the spiders ran out of the box, Sally burst out with, ‘I wish she were dead!’

“‘Dead and buried?’

“‘Yes, only I don’t know where I should be.’

“‘Well, where would you be?’

“‘At this question she manifested much displeasure, as it suggested horrid possibilities; she was unwilling to continue the conversation, but as I persisted she finally remarked, ‘I don’t see how I *could* be dead, but I suppose I would have to be.’ [Sally never liked to admit that she and Miss Beauchamp were one person.]

“‘Why would you have to be?’

“‘I don’t know. I don’t think it would be nice to be all mouldy and shut up in a box with nasty worms and things.’ Her mobile face as she said this was most expressive of these horrible possibilities. She seemed to think it possible for herself to be alive while Miss Beauchamp was dead, and yet she could not reconcile this idea with what she knew of material things. (There is some logic in this, as in her present life she regards Miss Beauchamp and speaks of her, though in a metaphorical sense as ‘dead’ when she, Sally, is in existence. At

such times Sally has no consciousness of Miss Beauchamp's existence. 'Where is she now?' Sally often asks.)

“‘You both have the same arms and legs, have n't you?’ I argued.

“‘Yes.’

“‘Then if her arms and legs were all mouldy, yours would be too, would n't they?’

“This capped her displeasure, and as she seemed to think it must be so she refused to talk more about it.”

## CHAPTER XI

### THE BIRTH OF B IV, "THE IDIOT"

**I**N June of this year (1899) there occurred some important developments which were not only of psychological interest, but which were destined to give an entirely new aspect to the case. Another personality appeared. Up to this time the psychological problem had been comparatively simple. Two persons had been contending for the mastery of life, each insisting on her own prerogative to live, but there had been no doubt about which was the Real Miss Beauchamp. Now a third person came upon the scene; one whom we had never met before, but who seemed quite as much a real person as did the Miss Beauchamp whom we all knew. "Where did she come from?" "How did she get here?" and "Who is she?" were the questions. Her advent plainly brought new problems to be solved, and raised doubts about the identity and origin of our old friend. More than this, her coming brought new complications into the life of Miss Beauchamp, who had more and sorer trials to undergo, worse than anything she had as yet passed through. I shall give in considerable detail the circumstances under which this new personality came, in order that no doubt about the absolute spontaneity of her origin may be raised:

One day (the evening of June 7) I was summoned to visit Miss Beauchamp at her house. On my arrival I found her in a condition of intense nervous agitation, and looking extremely fatigued and depressed. So nervous was she that she was scarcely able to keep her limbs in repose a moment. She had left my office in good condition

only a few hours before, and the sudden change was difficult to understand. It was not until several months afterward, in the autumn, that the real exciting cause of this evening's events was revealed, — a mental shock of great significance, which, unknown to me, she had received that afternoon shortly after leaving my house. I will narrate the events in the order in which they were disclosed:

On my arrival, as I have said, Miss Beauchamp exhibited great depression, fatigue, and nervousness, a condition usually observed in her when under mental strain. She was reticent, answering questions in monosyllables, and volunteered almost no information. She was anything but sociable. Her reticence seemed to amount to an aboulia, and she gave the impression that something was on her mind. After a few minutes of this an extraordinary change came over her. She appeared natural, tranquil in mind and body, and sociable. All nervousness and signs of fatigue ceased. She was without aboulia and chatted pleasantly; in fact, seemed a new character, healthy-minded, and with every bit of reserve gone. I had never seen her so natural and sociably disposed, and the change was puzzling. A few moments before she had complained of insomnia, which had frequently played havoc with her nerves, and as this is always easily controlled by suggestion, I arose from my seat and approaching her made a gesture as if to stroke her forehead and eyelids for the purpose of inducing hypnosis. To my surprise she strongly resented this, saying, "No one shall do that but Dr. Prince." It was evident, then, in spite of her naturalness, that she had a hallucination and mistook me for some one else. I asked her for some writing paper for notes. She walked across the room and brought me some sheets of blue note paper and some of white.<sup>1</sup> On these I made the notes from which this account is written.

<sup>1</sup> These and other details are important, as will later appear as the evidence is brought out. See footnote 1 page 177, and page 253, text, for explanation of remark just quoted.

"Am I not Dr. Prince?" I said in reply to her last remark.

"You know you are not."

"Who am I?"

"You ought to know."

"Who?"

"Will."

"What am I?" [Referring to my profession.]

"You ought to know." Then, offended as if I had been flippant, "Don't talk that way."

I persisted in maintaining my identity, trying every sort of argument to prove it. At first she treated my statements as a joke; then responsively played her part, saying that, if I would have it so and wished to play that part it should be so, only she knew I was n't Dr. Prince. She was bright, lively, and quick at badinage. There was nothing for me to do but accept the situation and play the part of William Jones. Presently she asked, "Why do you come here? You run great risks."

"Why?"

"You ought to know. I am not going to preach," etc., etc. "Things are different from what they were ten years ago."

Her whole mental attitude showed that she believed that I, as Jones, knew the facts and circumstances as well as she did, and therefore what was the use of masquerading? But I was entirely in the dark as to the meaning of it all, particularly as I did not suppose at the time that she imagined herself somewhere else than in Boston.

"How do I risk anything?" I persisted.

"You risk breaking your neck, for one thing," she laughed.

This answer puzzled me, but in reply to my question as to how she supposed I came there, she answered, "Of course you came through the window."

As we were on the third floor of the house, this answer, though in my ignorance it appeared to explain the joke, seemed to me at the time some fantastic idea. I denied this statement, so after some fencing she asked facetiously, "Did you knock at the door?"

I explained that I had rung the front-door bell in the customary way and had asked for her.

[Horried.] "*You did n't!*"

"Why not?"

"You know why not. I never saw any one so absolutely reckless."

As a matter of fact, I did not see why William Jones, or I myself, or any one else should not ask for her at the door in that way. (It is only completely intelligible by the light of later revelations.) But remembering Miss Beauchamp's views, and what I knew of the affair, I attributed it (wrongly) to social considerations. After some further discussion, in which she still insisted upon the un wisdom of my coming, but at the same time took it all in the spirit of a lark, I put a series of questions to her to determine whether her memory was continuous for the events of the evening, — that is to say, whether she was in the same state of consciousness as at the time of my arrival, when she recognized me as Dr. Prince.

"Who was here a minute ago?"

"There was n't any one here."

[In a surprised tone.] "What! there was n't?"

"No. You are perfectly mad."

Again I repeated the question, insisting emphatically that some one had been there, but again she insisted upon the contrary, as if the question were an utter absurdity and it was impossible any one could have been there. (This tone also struck me at the time as curious.)

Coming directly to the point, I asked, "Was n't Dr. Prince here?"



"What an absurd question!"

"Well, was n't he?"

"Why, no."

I insisted that he had been.

"It is absurd."

"Why is it absurd? He is your physician."

"I don't require him."

"Yes, you do."

"Not here.<sup>1</sup> I am not sick enough for that."

"They told me downstairs," I continued, "that he was here."

"What on earth did you come here for, then?" (The recklessness of my conduct at once strikes her.)

I repeat my last remark, but she replies, "Will, you know perfectly well that is n't true."

It was thus made plain that Miss Beauchamp had no memory for the events of the early part of the visit when she had recognized me. Her memory was not continuous for the whole evening, but went back only to the moment when the outward visible change came over her. It was also plain that a change of some kind had occurred since my entrance, and that I was either dealing with something different from any state I had met before, or else that Miss Beauchamp herself had suddenly become free from her peculiar stigmata, but at the same time the victim of amnesia and an illusion. The change in character and physical condition, and the cleavage in memory pointed to the former view; just as the perfectly logical attitude of her mind, the normality of her character, her spontaneity, and the absence of all nervousness, rendered the latter hypothesis improbable. But there still remained much that was puzzling.

If on the other hand she was B I and was the subject of an illusion, the latter was not extraordinary as I had

<sup>1</sup> Note the reference to the locality.

known Miss Beauchamp, when nervously ill, and even when in hypnosis, to have illusions, but it was difficult to reconcile it with her amnesia for the early part of the evening and at the same time with her normality in other respects. I did not realize at this time, what I afterward learned, that she imagined herself in a distant city. Therefore it seemed odd that she should believe I had come in through the window — the room was on the third story — and that she should be disturbed because I (Jones) had asked for her at the door. Still I put it down to a freak of delirium, or to an idea of a breach of the social convenience. The real reason appeared only in the sequel.

But I would again emphasize certain peculiarities of her delusion which have great significance, and which should be kept in mind. First, I was mistaken for some one else; second, she mistook her surroundings; third, she thought that I, as another person, had come in by the window; fourth, my visit was a great indiscretion, and it was undesirable that any one should know of my being there. (Even supposing I were Jones there did not seem to be any reason for this.) Fifth, she did not require Dr. P. (myself) in the place where she supposed herself to be.

All these details afterwards became clear when the true explanation of this episode was found. At the moment, so marked was the change, the question arose whether this was a real personality, distinct from Miss Beauchamp, and if so, who it was, and why these illusions. It plainly was not Sally; and Sally herself, who came later, disclaimed the identity. At the moment, making the test for anesthesia,<sup>1</sup> it was found that cutaneous sensation was normal; but on giving her a French book she was unable to read it, as Miss Beauchamp could do; so that she lacked certain peculiarities of Sally and B I, respectively.

<sup>1</sup> One of the tests for Sally, who, it will be remembered, had a peculiar form of anesthesia.

On further testing her memory, what seemed a contradictory condition developed; namely, she remembered many incidents, but not all of that same day, though she must have experienced these as B I. So that if she was a personality distinct from B I, then her relation to B I seemed on this evidence to be like that of B II or B III;<sup>1</sup> or the cleavage was not complete, and, on her side at least, her consciousness dovetailed into that of Miss Beauchamp. I may anticipate here by saying that the true explanation, which developed some time later, showed that this knowledge of B I's later life was more apparent than real, and that it consisted of fragmentary, abbreviated, and occasional sort-of-clairvoyant glimpses, which offered for study some very interesting psychological phenomena.<sup>2</sup> These came automatically out of the depths, without logical conscious associations, and contributed temporarily to a wrong understanding of her memory. As a matter of fact, the cleavage was, or shortly became, complete, and the new personality, for such it proved to be, had no *direct* consciousness of the events of B I's life. These facts are mentioned here for the sake of completeness, and to show some of the difficulties of the problem at this time. Her knowing *some* of the occurrences of the day misled me into thinking that she had a wider knowledge.

Thus spontaneously in my presence a new personality was born.

After observing her for some time it became essential that the illusion regarding my identity should be dispelled. This was finally accomplished by showing her my name engraved in the back of my watch. The effect was pecu-

<sup>1</sup> That is, she knew Miss Beauchamp's life.

<sup>2</sup> See Chapter XV. Of this character was the apparent knowledge of me implied by her remark that no one should hypnotize her but Dr. Prince (page 172).

liar. As she gazed at it she seemed for the moment confounded. "How did you come by that?" she asked, astonished, and as she tried to reconcile in her mind my (Jones's) possession of another person's watch, she became abstracted and confused; a change came over her, and suddenly Miss Beauchamp reappeared with entire oblivion of everything that had happened since her disappearance.

Later still, Sally came, but she was unable to throw light upon the new personality. She noticed her peculiarities, including her amnesia for the early events of the evening, and her apparent memory for other events in Miss Beauchamp's life, such as having been hypnotized by me; but nevertheless Sally insisted, and to this she adhered for a long time with pertinacity, that "She" was not a "person." "There are not three of us, and there sha'n't be, and that's all there is about it," she declared.<sup>1</sup>

A day or two after this episode the new personality walked into my consulting room. This time, completely free from her illusion, she addressed me by name, but manifested an air of formality such as might have been shown by any patient with whom one has not a long-standing acquaintance. Indeed, she was conspicuously formal in her attitude, more so than Miss Beauchamp had ever been. There was no difficulty in recognizing her as the new personality, but so far as the extent of her memory went, everything seemed to be so much a matter of course with her on this occasion that I was misled. She remembered, or rather professed to remember, her illusion of taking me for Jones on the evening of June seventh, but could not give an explanation of it. In manner she was very quiet and composed, much as she had been on her first appearance, — and strikingly different from Miss

<sup>1</sup> In the months that followed, Sally at times studied this new personality with considerable interest and intelligence, and contributed considerably to our knowledge of her.

Beauchamp. She was affable and agreeable in conversation, and did not exhibit the slightest evidence of aboulia. She conversed as if she had the same knowledge of past events as had B I, B II, and Sally. It did not occur to me at this time, so cleverly she acted her part, and so misled was I by the previous knowledge shown, to question this assumption. By her conversation she allowed, or rather encouraged, me to infer that she knew all about B I,<sup>1</sup> just as B II and Sally did. The time was not propitious for a thorough investigation, which would probably have been resented, so that the interview was little more than a social one. Her mental characteristics were strikingly different from those of B I, but to avoid repetition these will be mentioned later in connection with certain observations which give a deeper insight into the peculiarities of her character.

Afterwards, when I began to revise my notes and to think over the interview, it was impressed upon me that this new member of the family volunteered very little information regarding the past, that it was I who spoke of past events and of herself as if she were familiar with all, and that she simply assented in a way to convey the impression that she knew everything. As a matter of fact, later revelations showed that at this second interview she was playing a part. She did know my name,<sup>2</sup> and therefore of course the character of my profession. But it is questionable whether she had any real knowledge based on past professional relations, or any real memory. Both she and Sally now say she did not. She now explains that from the professional character of the room, the drift of my questions, and my attitude towards her, she was able to infer much, to follow the leads given, and to avoid betraying her ignorance. Not being subjected at this

<sup>1</sup> That is, all about her life when B I was in existence.

<sup>2</sup> Possibly from the doorplate.

interview to a critical psychological examination, as afterwards was done, her replies to questions, if they were not direct-fibs, were so adroitly framed that they intentionally conveyed the idea of familiarity with and knowledge of the subjects in question.

It was only later,<sup>1</sup> when I made a thorough investigation of this personality, that it was discovered that her position was much like that of some one who had dropped from the planet Mars and found herself amongst people who were complete strangers to her, and with whom she had no sympathy or associations; but it was more than that, for she found these people knowing all about herself, talking about events of her immediate past of which she knew nothing, and yet which she was convinced from the evidence must be true. Determined not to give herself away, she cleverly parried dangerous questions. This meant also that she knew nothing of herself as B I or as Sally, and therefore was ignorant that she had other personalities. She believed herself the sole individuality and that she had no other life. This is an important fact to keep in mind if the psychological situation is to be understood. She soon came to be known as B IV, and by this title it will be convenient to speak of her now. From the time of her first appearance she kept changing places with the other two personalities, but knew nothing of what was done by either of them. She was ignorant of the places and persons associated with their lives. My office, for instance, as has just been stated, was strange to her; and many persons with whom she found herself in friendly relations she looked upon as total strangers. She would lose her way in the streets, and often wandered about hopelessly, disliking to ask her way and exhibit her ignorance. Consequently, to inform herself, she was obliged to resort to guessing, inferring, and "fishing." She was

<sup>1</sup> Chapter XIV.

keenly alert for every clew, and extraordinarily clever in "catching on." Sally, who became informer, noticed all this and had no patience with her.<sup>1</sup>

Now, it should be stated here that, although Sally knows<sup>2</sup> everything B IV *does*, nevertheless Sally does not know B IV's *thoughts*. This in itself shows a very interesting psychological difference between the relations of Sally to B I and to B IV. Sally is conscious of B I's inmost soul; of B IV's mind she knows nothing; she can only *infer* B IV's thoughts from what she says and does. But Sally studied B IV closely, and arrived herself at the conclusion that B IV, in spite of her pretensions, knew nothing of the events of the past few years of Miss Beauchamp's life, but was always "fishing" for information and guessing. In her astonishment, — for Sally could not understand the meaning of this new personality, — she repeatedly exclaimed, "Why, she does n't know anything! She is always 'fishing' and guessing!"

Sally always spoke of her as "She," as she did of B I, and similarly refused to admit the identity with herself. It took Sally a long time to get accustomed to B IV's ignorance, for she, too, at first, was taken in by the new person's pretences; consequently there came to her a constant series of surprises in finding that the new one was

<sup>1</sup> The reader will probably wonder, as I did, how B IV happened to come to my office as she previously had not known me, and did not know where I lived, or that she as Miss Beauchamp was under my care. At the time of her visit, supposing that she had a thorough knowledge of the past, I inferred that she had come to fulfil an engagement made with Miss Beauchamp. Later, after her ignorance of the past was discovered, I elicited the fact that it was B I who had started to make the call, and on the way had changed several times, back and forth, with Sally and B IV. B IV walked on in a mechanical sort of way without any particular knowledge of what she was going to do. It was B I who had rung the door bell, changing on entering the house to B IV, then back again to B I on the staircase, finally entering the room as B IV.

<sup>2</sup> It is not necessary, at this time, to inquire whether her knowledge came to her directly as a subconsciousness, or afterwards as a memory while an alternating personality. (Compare Chapter IX.)

ignorant of a large part at least of Miss Beauchamp's past life, and of all the present when B I and Sally were on the stage. Watching her intently, she found her doing and saying things that were incompatible with a knowledge of such periods, and also found that her remarks were largely based on the "fishing" and guessing. Nor could Sally understand *why* B IV did not know. When at last Sally discovered the new person's ignorance and her pretences, her contempt for her became unbounded. She dubbed her the "Idiot," and by this name B IV was known for a long time. I mention this to emphasize the ignorance of B IV in regard to her immediate surroundings, and to the facts of Miss Beauchamp's life. But later, when the opportunity offered to make a study of her, it turned out that this ignorance was not of Miss Beauchamp's whole life but only of the past few years. So that at some, as yet undetermined, period, her memory ceased for everything, and began again on the night of June 7, 1899. As B IV did not know of B I or Sally, there were, of course, gaps in her memory, corresponding to the times when the other two members of the family were present, and B IV showed great acuteness in trying to find out what happened at such times.

It was not as easy as it would seem to be to determine the reality of this amnesia. For a long time I could not feel sure that she was conscious of the gaps, and that one period of consciousness did not seem to her to run into another, in spite of the interval of oblivion; for our new friend resented as an impertinence all inquiry into her private affairs. Her attitude was perfectly intelligible. She found herself suddenly surrounded by strangers, who advised, directed, and controlled her life by some apparently occult power (though it was really through B I and Sally). One of these impertinent strangers, myself, most inquisitively pried into her thoughts and directed her life.



She was quick-tempered (Sally called it a "nasty temper"), and this surveillance irritated her. Indeed she not only objected to any interference, but resented it as an impertinence. I must confess that, from her point of view, there was much to justify her attitude, and one can hardly blame her when her strange situation is kept in mind. She determined that submit she would not, and so did everything in her power to foil inquiry.<sup>1</sup> She refused to admit the gaps in her memory and declared that she knew everything. I mention all this here to show the difficulties besetting this study. Every interview during the early months of B IV's life began with tiresome sparring. Yet it was not difficult to convict her of ignorance by a few test questions about her doings when B I or Sally was in the flesh. After quibbling, evading, inferring, and guessing, she would break down and confess she did not know; and this was the fact.

But whatever the memory of the "Idiot" for the facts of her life as B I, it was easy to show that our oldtime friend knew nothing regarding the "Idiot." The memory of B I was absolutely blank for everything that occurred, everything said and done in this new state. For a long time she never had a glimmer of a suspicion that there was anybody beside herself and Sally; and, indeed, imagined that when she was in this new state of consciousness she had simply "lost time," and had been masquerading as Sally. In fact, it too often happened that later Sally got the credit or discredit for many acts of which she was guiltless.

To summarize briefly the results of later long-continued study, B IV had individual peculiarities of character, of disposition, of tastes, of habits, of memory, and of physique. Her physiological reactions to the environment,

<sup>1</sup> She later analyzed and wrote out for me an account of her mental attitude at this time. See Chapter XIV, p. 244.

and her mental acquisitions, too, were in some respects different. Her state of health was different from that of B I. She was much more normal, more healthy in mind and in body than was Miss Beauchamp. She was without aboulia, had more self-control, more courage, less reserve, and in sum and substance, less and more of a number of peculiarities not difficult to describe, but which I prefer to let appear in connection with later phenomena.

Thus the new mental condition exhibited by Miss Beauchamp was clearly shown to be a personality, and was rightfully given the title of B IV.

The relation of the different personalities then to one another was this: B I knew nothing of either of the other two personalities; B IV knew apparently something, but really nothing directly, beyond scrappy isolated memories, of B I and nothing of B III; B III knew all about the acts of the other two, but the thoughts of B I only.

And so it came about that, from this time on, three personalities, instead of two, kept changing with one another. The social complications became at times hopeless. The length of time when each personality would be in existence would vary from a few minutes to several hours or days. Sometimes two would hold the field for several days, when the third would appear. On one occasion B I was absent, or "dead," as Sally called it, for a month. I must defer to another chapter all but a reference to the extraordinary adventures and misunderstandings of these three persons, brought about in part by the ignorance of Miss Beauchamp and the "Idiot" of each other, and the consequent conflict of their plans and doings; in part by the difference in character of all three; and in part by the mischievousness of Sally, who concocted a little *Midsummer Night's Dream* of her own, and as Puck, with a little dash of Iago, played her pranks on both. Some of these adventures were laughable, and some tragic.

Thus a new problem had been brought into the situation which was this: Up to June 7, 1899, we had apparently Miss Beauchamp, neurasthenic and unstable, it is true, but still the primary personality, and a second person known as Sally, who may be termed a secondary personality. Now a third one had come, more normal in some respects than Miss Beauchamp. Who was she?—and for that matter who was who, and which was the Real Miss Beauchamp, or was any one of the family the real one? The normality of B IV threw suspicion on the identity of our Miss Beauchamp, the one whom we had known so long. Could it be possible that our Miss Beauchamp, the saint, was not real? The thought was startling. But the first idea to suggest itself was that the new person was B II, who had of late largely dropped out of sight. If so, she was in a more highly developed state. But various considerations at once disposed of this idea. Sally, when questioned, asserted most positively that B IV was not B II, and gave various reasons for this assertion, the most cogent being that Sally knew nothing of the new personality's thoughts, although she knew all about those of B II. More than this, B IV, unlike B II, knew nothing of B I. Clearly, therefore, they could not be the same personality.<sup>1</sup> Eliminating this theory there did not seem to be any law or order in the psychological developments. The question was what relation did the different personalities bear to one another. Which was the Real Miss Beauchamp? And there was the second important question, What was it that had brought them into being? or at least, What had happened that afternoon to bring the Idiot. The answer to this latter question I was not destined to learn for some months, and then it was found to be bound up with the mystery underlying this whole case.

<sup>1</sup> At a later period I was able to bring both B II and B IV as distinct states, and then it was found that B IV knew nothing of B II.

With the exception of Sally, all seemed higgledy-piggledy. Unless law and order could be shown to govern the psychological phenomena they were incomprehensible, and intelligent therapeusis was impossible.

As has just been intimated, close observation of B IV soon awakened the suspicion that it was she who was the original and true Miss Beauchamp, who, for some unexplained reason, had disappeared at some time in the past, and had only reappeared for the first time on the night of June seventh. Many cases of this kind are known. For instance, the case of Reverend Ansel Bourne may be mentioned, as it was carefully studied and investigated by Prof. William James and Dr. Richard Hodgson. The reverend gentleman awoke one day to find himself living under the name of Brown in a country town in Pennsylvania. Here he had been living two months, keeping a small shop which he had opened. On coming to himself, he did not know where he was or how he had got there. It was proved that two months previously a sudden change of personality had occurred, and that he had wandered from his home in Rhode Island to this town in Pennsylvania, where he had since been living. His memory in his normal state was a complete blank for this period of his secondary personality.

This hypothesis — that B IV, like Mr. Bourne, was the real self — would explain why I and others were strangers to her, and also why she was not familiar with many facts of her life and with her surroundings. Possibly, if the circumstances of her disappearance were known, they might explain her peculiar delusions on the night of her awakening. But at this time there was little to make this idea more than a hypothesis. If it were true, then it would follow that B I, Miss Beauchamp, was nothing but a pathological entity, a somnambulist perhaps, having no right or title to existence, and must be made to disappear.

## CHAPTER XII

### A HOUSE DIVIDED AGAINST ITSELF

**D**URING the following summer B IV came and went, changing places with Sally and Miss Beauchamp as in a stage comedy. The complications had been bad enough when there were only two persons, but now that there were three, the situations became woefully tangled. I saw nothing of any of them during July and August, though in frequent correspondence<sup>1</sup> with Miss Beauchamp and Sally, but I learned afterwards of their doings. A pretty mess they made of it, each playing her own game regardless of the others. Poor Miss Beauchamp was in despair, and got into a hopeless state of mind not to be wondered at. She had not only "lost much time" — the greater part of the summer, in fact — but had also lost a number of valuables, including some rings, a necklace, a watch, and several borrowed books. She had written unconsciously to Jones letters which put her in false positions, to say nothing of the usual flood of letters to herself (from Sally, of course). To cap the climax, she learned from one of Sally's letters that she had borrowed quite a sum of money and had promptly lost it. Miss Beauchamp, of course, was in the dark about the way all this had happened, and ignorant of the fate of her valuables. Whatever meagre information she had came from Sally's letters. In

<sup>1</sup> The numerous letters received were from B I and B III only, — a fact of some significance. B IV never wrote me during the summer: our acquaintance was too new and formal for correspondence, being limited to a couple of interviews not of her seeking. Naturally, therefore, she refrained from bringing her affairs to me, nor did she want my interference.

her anxiety for news she had sought Dr. Hodgson's help, under the natural assumption that Sally was the culprit. It was again the old story of a bad name, for she did not realize that there were now in the family besides herself two others, instead of one.

It was through the aid of Sally and B IV that the snarl of events was unravelled and the plot explained. To lose the money which had to be repaid and which she could ill afford to lose was bad enough, but it was galling to have been put into such a false position. All this led to a series of adventures which had an amusing side, and which will be told presently. It was B IV who had borrowed the money, and it was also B IV who had lost a ring which Miss Beauchamp treasured, wearing it on a chain around her neck. One day, while sitting on the rocks by the sea, B IV was absentmindedly fingering the chain; it came apart and ring and chain fell into the water, where they could not be recovered. The other rings were not lost, as Miss Beauchamp supposed, although she (B I) could not find them; this was owing to negative hallucinations. They were literally directly under her nose — yet, owing to this psychological phenomenon, she could not see or feel them. Sally had strung them for safety on a ribbon about her neck, where they were later found. The borrowed books Sally — this time acting as guardian angel — had sent to the Storage Warehouse for safe-keeping, but had not thought it necessary to acquaint Miss Beauchamp with the fact. But it was B IV who had carried on with Jones the correspondence which, as it directly reversed the attitude in certain matters which B I had taken before B IV came, particularly annoyed the former.

Then Miss Beauchamp had disappeared for weeks during the summer, leaving Sally and B IV to alternate with each other and to run the campaign. B IV managed the family affairs according to her own ideas, which agreed with

those of Miss Beauchamp about as well as Katherine agreed with Petruchio. Then Sally would just drop a line to B I that she might know what IV had done, if it happened to be particularly galling to I's feelings.

Finally, Miss Beauchamp conceived the project of going to New York to recoup her financial losses. The adventures which followed from her attempt to carry out this plan are amusing. She actually got as far as New Haven, as will be presently narrated. The following are the details of the observation showing:

*Spontaneous Negative Hallucinations.* [Notebook, October, 1899.] "Apropos of the rings, some very unusual phenomena, of the order of spontaneous negative hallucinations, as well as the history of the simultaneous action of two consciousnesses, were brought to light to-day. Miss Beauchamp had accused Sally of having taken some rings which she cherished. Sally explained in her own defence that all the rings were not lost; that 'She' thought she had lost her rings but had n't; 'She' had lost one old ring which was attached to a chain around her neck. 'The other two rings are not lost,' said Sally, 'but I can't make her see them. I have put them on her finger, but she won't see them, Dr. Prince; and I have taken her hand and made her take hold of the rings, but she won't feel them. They are round her neck now on a ribbon. I have made her take the rings in her fingers while she is here and I am "gone," and I have put them on her finger; but it is no use, she won't see them.'

"B III was examined very closely on this episode, with a view to obtaining light on the relationship between I and III. If B III's statements could be established they would show that:

"(1) B I had negative hallucinations induced by the strong auto-suggestion that the rings were lost.

"(2) B III as a coexisting subconsciousness had tried through a logical process of reasoning to make B I see the rings; and that as a subconsciousness Sally had 'taken her hand' and tried to make her feel the rings. This meant that Sally had thought and acted like a person who was in existence con-

temporaneously with B I. There would have been a coexisting motive, a coexisting desire, a coexisting process of reasoning, and a co-action. This meant two coexisting real personalities, that is, a primary and a subconsciousness."

Introspective evidence of this kind of course cannot be confirmed experimentally, but the negative hallucinations could be demonstrated.

"B I was now awakened with Sally's consent, and was informed about the rings as follows: 'You think you have lost your rings.' She assented. 'Well, you have n't. I know where two of them are. The third, the one that was on the chain, is lost, but I can put my hand on the others whenever I please.'

"'Can I find them?' she inquired.

"In reply I bade her unloosen her collar. About her neck was tied a ribbon, and on the ribbon were the two rings, as Sally had said. I made every effort to have Miss Beauchamp *see* the rings and ribbon, to *hear* the click when they were struck together, and to *feel* them with her fingers, but without result. She simply could not see, hear, or feel them, and at first thought me joking. Though it was sought by suggestion to dispel the hallucination, the only effect of persisting was to make her think she was being guyed. After a while she assented to the suggestion, but it was evident that she did so to agree with me. Then, in response to my insistence, 'Well, you say I see them, and I am willing to say I do, if you wish it, but I don't see them.' I pulled the ribbon hard enough to jerk her head and to make her lose her balance. At this she remonstrated, 'Don't jerk my head.'

"'How can I jerk your head if I have nothing in my hand [the ribbon], as you insist? In that case there can be no connection.'

"'I see your hand move so, and I feel my head go so;' and from this she inferred some kind of hypnotic connection, without understanding its nature."

Spontaneous phenomena of this sort, of the intensity manifested in this observation and which cannot be dis-



pelled by external suggestion or by the subject's voluntary attention, are, I believe, unique. Miss Beauchamp stood in the middle of the room, the rings suspended from her neck, while I pulled the ribbon and dangled the rings before her eyes in the vain effort to make her see them. Under the dominant idea that they were lost, heightened by the emotional effect — worry and intense regret — that this idea had caused, she could not see what was under her nose. When one remembers that it was one of her own selves who, in distrust of the primary self's absentmindedness, had attached the rings to the ribbon for safe-keeping, the situation seems curious, to say the least. The study of negative hallucinations of this sort is interesting from the light that it throws on some of the ordinary phenomena of absentmindedness, such for example as the time-honored instances of people, generally professors, who cannot find their eye-glasses which lie on the table under their eyes.

The systematized anesthesia for the rings differed in no way from that previously noted in the experiment with the metal rod (p. 67), excepting that the former was spontaneous, and in this respect was exceptional, considering the number of senses involved and the intensity and persistence of the (negative) hallucinations. The blindness was systematized in that it embraced only a special system or group of visual images, namely, the rings and ribbon about her neck. The same is true of the deafness for the sound of the rings clicking against one another, and of the tactile anesthesia when the rings were touched. The subject was anesthetic for any sensory impression associated with the rings. For all else there was no impairment of sight, hearing, or touch. In the experimental instance of the rod, the cause of the anesthesia was a suggestion from without. In the spontaneous case of the rings it was a suggestion from within, — an auto-suggestion. The intense belief that the rings were lost, and the consequent emotion,

induced the anesthesia in the personal consciousness of B I. That the images were formed nevertheless, although they remained isolated, is shown by the fact that not only Sally but B II remembered having seen the rings. "*I did not see the rings at the time,*"<sup>1</sup> said B II, "but *I* remember them now." The images as memories became united in hypnosis to this self.

This raises the question which was asked (p. 73), but passed over when discussing systematized anesthesia in a previous chapter (V). Speaking not of this particular case, but of systematized anesthesia in general,—What becomes of the isolated images? Do they remain isolated by themselves, or are they united to some other consciousness sufficiently complex to form a second personality capable of *personal* perceptions? By this I mean a consciousness that can say, "*I see, I hear, I feel.*" From here on the problem becomes complicated and can only be touched upon in this place. The answer must vary with individual cases, depending upon the degree of dissociation of consciousness present.

(1) In mildly dissociated cases the images probably constitute the whole of the secondary consciousness, and simply are isolated states without sufficient complexity to be described as a personality or *personal* perception, or to justify the use of the pronoun *I*. Such a condition may be observed in ordinary absentmindedness. When an object lying under the nose of an abstracted individual is not seen, we call it absentmindedness, which really correctly designates the condition. The mind is absent or dissociated. "Dissociated-mindedness" would be a more precise term. When a person in such a condition momentarily fails to see his spectacles which lie on the table before him, he has a negative hallucination. But the spectacles are seen subconsciously, which, be it always remembered,

<sup>1</sup> That is, at any of the times when B I did not see them.

means dissociated images. This may be easily proved experimentally. I have made numerous experiments on this point, and have found that sounds in the street, voices, visual images of passers-by, or surrounding objects which are not perceived by the primary personality, nevertheless give rise to dissociated sensory images, and thereby to a limited doubling of consciousness. When absentmindedly we do not hear what is said, see what is going on, or feel the tickling of a fly on the skin, the apparently unheard word, the unseen object, and the unfelt touch, are really heard, seen, and felt. It is only necessary to hypnotize the subject to demonstrate the fact. When the subject is hypnotized, the hypnotic self remembers and is able to describe these sensory experiences. But from my observations I believe that these sensory images—the spectacles in the supposititious case—remain isolated, and that there is no self—subconscious self—to which they become attached to form a personality and allow *personal* perception.

While the fundamental psycho-physiological principle of absentmindedness is dissociation, as is easily proved, nevertheless Dr. Janet is in error, in my judgment, in identifying hysterical anesthesia with the normal state of distraction. Both are forms of dissociation, but all forms of dissociation are not distraction. Sleep, trance, epileptoid states, hypnosis, etc., are forms of dissociation, but they are not absentmindedness. The demonstration of dissociation and doubling of consciousness in absentmindedness is of great psychological importance, for it means that dissociation is a normal process, and that there must exist some psycho-physiological mechanism for bringing it about. Here, too, it may be pointed out that *concentration of attention* may be regarded as a form of volitional absentmindedness and probably makes use of the same apparatus. Abnormal dissociation may be only a perversion of this same apparatus.

(2) In more extensively dissociated cases, such as the profounder forms of hysteria, there may be a secondary consciousness of such complexity as to constitute a veritable personality. With this secondary consciousness the sensory images of anesthesia (dissociated from the primary personality) may be united, and such a subconsciousness could veritably say, "*I see,*" "*I hear.*" Dr. Barrow's case of Miss Anna Winsor ("Old Stump") was of this type. While the patient was engaged in conversation, the subconsciousness, making use of the right (paralyzed) hand, called "Old Stump," wrote poetry, drew pictures, etc. During an attack of delirium it wrote a prescription.

In the case of Miss Beauchamp and the negative hallucinations of the rings, the conditions are very complex. A secondary consciousness of considerable extent (Sally) already existed. The dissociated sensory images of the rings formed a part of this consciousness, which, if her statement be accepted, could say, "*I saw them.*" There was subconscious personal perception. This is in accord with numerous observations made in this case. In contrast with Sally's personal perception, B II could only say: "*I did not see the rings, at the time, but I remember them now.*" The images apparently belonged to more than one subconscious group.

Sometimes Miss Beauchamp's negative hallucinations were caused, not by the intensity of her own ideas, but by the mischievousness of Sally, who deliberately and wilfully would act by "willing" on Miss Beauchamp's consciousness, and prevent her seeing what was before her. Instances of this kind also occurred about this time, as will presently appear.

To return to the adventures of the trio: The part which B IV played in demoralizing Miss Beauchamp's life becomes intelligible if it is kept in mind that she knew nothing of Miss Beauchamp's thoughts or feelings; nothing

about her life during late years; nothing of her ties or duties assumed; and that necessarily she knew nothing of her wishes, intentions, or relations with people and events. For her there was no other ego but herself. Naturally therefore she was, from her own point of view, a free lance to do as she pleased. And in the doing she went back in her mind to the life of six years before, which she imagined herself to be still living. Yet it must be confessed that later, when she did learn something of her other self, she refused to show any consideration for any one's wishes but her own. She was such a different character, in tastes, points of view, opinions, and modes of thought, that whatever she did would necessarily be repugnant to Miss Beauchamp. She had no affiliations, *apparently* cared for nobody, and had no sense of responsibility to any one. Add to this an irritable temper, which made her angry whenever restrained or placed under circumstances which she did not enjoy, and we have the key to her conduct.

Sally meanwhile was enjoying it all, and did not miss any opportunity to stick pins into both the others. She wrote them letters, taking pains to let poor Miss Beauchamp, especially, know what terrible things she had been doing, calling her all sorts of names, and magnifying the enormity of her sins. Miss Beauchamp took it all *au pied de la lettre*, imagined much more, and was very unhappy. A feeling of terror was created in her mind, by not knowing what she might have done when she was "gone," and by imagining from Sally's Iago-like letters all sorts of possibilities. The times when she disappeared increased in length and frequency, until, finally, she was "gone" for a month, — from the end of July to the last week in August.

The following letter of July 27 hints at her state of mind:

“I am glad to hear from you, but I can’t imagine what the note is to which you refer, for I haven’t written J —<sup>1</sup> this summer, and yet there is no one else whom you would be at all likely to confuse with him. I am sorry. Perhaps it is, as you say, something written by my other self, or one of my other selves, for, if ‘Sally’ is to be believed, there are several. About seeing you — you are awfully good, but I cannot come just yet, much as I need and would like to. I am too nervous and would only annoy you. But I do wish you would tell me if there is any one to whom I could appeal in case of emergency while you are away — any one who would not think me wholly mad, or who would in the least understand what to do. I am afraid to be so entirely alone. As for my plans, they are in a most chaotic state, I am sorry to say. I hoped to remain in — all summer, but it was impossible, and so I am back on — St. for the present, where it is at least quiet, as there is no one in the house except the caretaker. I don’t know how long I shall be here. Do you know, Dr. Prince, I have forgotten everything — *absolutely everything* that I learned with such difficulty<sup>2</sup> during this last year. Will it come back to me again, do you think? Please tell me. And if it does n’t, what shall I do? Don’t tell Mrs. X., — don’t tell any one yet. Let me get a little used to it. . . . Hoping I have not taxed your patience too severely, I remain, believe me,”

It will be noticed that Sally has taken pains to tell her that there is more than one devil inside her, but as yet she does not thoroughly realize it. The acquisitions she has lost are the ability to write shorthand, and her knowledge of French<sup>3</sup> and other foreign languages.

The following letter was received from Sally, August 2, in reply to one of mine reproaching her for breaking the promises which she had given not to tease Miss Beau-

<sup>1</sup> A letter written by IV to J —, and either by mistake or through Sally, put in the wrong envelope and mailed to me.

<sup>2</sup> Referring to the constant alternation of personalities, and Sally’s destruction of the notes of the lectures, etc. This amnesia was only another example of dissociation and was temporary.

<sup>3</sup> The languages had been learned in college, but shorthand the preceding winter.

champ. What she says is literally true; she could not keep promises of this kind, and always said so.

"I wonder if you half realize how very unfair you are to me. It is n't true that I tell lies and break all my promises and have no sense of honor. You know it is n't true. I have never lied to you except concerning one thing, and that was absolutely necessary — absolutely, really — and I think even you would forgive me if you knew all about it. Nor have I tried to deceive you ever, save half in fun when I wanted you to think me Miss Beauchamp — but you always knew at once that I was n't. As for breaking promises, have I ever broken one that was given voluntarily? When you wring them from me by sheer force of arms, and I tell you, even as I give them, I *cannot* keep them, it seems to me that is very different. Won't you make the smallest allowance for me, Dr. Prince? I cannot bear to have you speak so.

"She has not waked up at all since Monday. I think she is really dead.

"P. S. Please don't be cross — you know you said I might write if I chose, and this is n't a *very* long letter." <sup>1</sup>

There is a point to which it may be worth while to call attention here. In her letter of July 27 (page 196) Miss Beauchamp asked if there was not some one to whom she could go for help. Dr. Richard Hodgson had kindly offered to stand in *loco parentis*<sup>2</sup> in my absence, and I directed her to him. On August 22 she writes again to the

<sup>1</sup> The difference in style of this letter from that of her usual letters is noticeable. Now and then, under the dominant force of an idea or feeling such as Miss Beauchamp might have had, the expression of her thoughts took on a form which might have been used by the primary personality. It was the same with the facial expression. But I never knew her to exhibit the sadness and weariness of B I. In the last part of this letter Sally relapses to her old style.

<sup>2</sup> To Dr. Hodgson I desire to express my gratitude for the valuable assistance which he rendered in the practical supervision of the case during the earlier period of this study, when it was desirable to keep Miss Beauchamp under daily observation. Dr. Hodgson has thus had an opportunity to become personally acquainted with the different personalities and to continuously observe them during long periods of time.

same effect, though on August 19, and on several occasions previously she had gone to Dr. Hodgson, but it was in the character of Sally. Miss Beauchamp did not know this, for she had disappeared for the whole or nearly the whole of the preceding four weeks. The following is the letter from B I written August 22:

“I am awfully sorry, believe me, to trouble you again, but I think you wrote about some one to whom I could go in case of emergency. I need that some one now — very, very much — but unfortunately I have forgotten both the name and address you gave me. Can you send it again? I have lost weeks, — whole weeks this time. What does it avail struggling against it? I am so tired, so very tired !”

In September the family again came under observation. It had just had an adventure, the one already referred to, which was the outcome of Miss Beauchamp's project of going to New York. This is worth narrating, as it shows how the different members of the family played their parts and lived together, as well as the individuality of the different personalities. The family altogether was much like a barometer house with three inmates — when one was out, the others were inside. On September 3 Miss Beauchamp wrote as follows:

“I shall be awfully glad to see you any time you wish during the next few days. You will forgive me? I have been doing the most dreadful things — things I cannot bear to think of. . . . Is it possible or credible that there should be another — I hardly know what to call it — another *thing* like ‘Sally’ ?

“P. S. Address — Street.”<sup>1</sup>

On September 5 the following note arrived from Sally, who evidently was frightened at the effect which all these escapades were having on Miss Beauchamp:

<sup>1</sup> This letter gave a different address from the usual one, and indicated that her residence had been changed.



"Won't you *please* write and say that she may come to-day? I want you to — so very much. I'm afraid she is going to be really ill, and I don't know what to do, and there's no one here, and it's perfectly dreadful altogether. I want you to come to Boston. Please, *please* do, Dr. Prince. I won't talk to you at all, and I'm awfully sorry to have annoyed you with that letter. Truly I am."

I will let my notebook tell the story:

September 6th:<sup>1</sup> "To-day Miss Beauchamp called by appointment. She was in much distress, discouraged, and expressed a desire to end the whole thing and give up the fight. She said that she was mentally worse, having lost whole weeks and in fact the greater part of the summer; that she had done awful things, which she 'could n't,' that is, 'would n't' tell me, and evidently has been getting into terrible messes, putting herself into false positions, etc., etc. She appeared distressed by all that had happened, exhibited some aboulia of speech and slight stammering, and expressed a desire to commit suicide, saying that nothing else was left for her. Moderately nervous in movement. While I was talking to her she changed to Sally, who laughed as usual over the tribulations of her other self, but appeared more considerate and sympathetic for B I than she had ever been before. Sally disclaimed being responsible for all that had happened, declaring that she had done very little, and that what had taken place was not her fault. When questioned closely as to who was responsible, she was clearly puzzled. It was the 'Idiot' who was the cause of the trouble; that was clear in her mind, and exculpated herself. But who was the 'Idiot'? She could give no explanation of this point, nor of the relationship between the 'Idiot' and B I. It was plain, too, that the 'Idiot' could not be identified with B I. Nevertheless, Sally insisted; 'There are not three of us, only two'; but how it was that B I became the 'Idiot,' or who the 'Idiot' was, etc., she could not understand. As Sally described

<sup>1</sup> It was at this and subsequent interviews that the first thorough study of B IV as a personality was made. Up to this time, since the seventh of June, she had been observed only twice.

the course of events, her attitude was that of one who had watched with relish B I changing to B IV and back again, and the messes in which they became involved, much as one watches a play upon the stage.

“The following is Sally’s account of the New Haven adventure. Both B I and B IV corroborated their respective parts in the affair, so that this narrative is supported by the testimony of the whole family. There is in addition some documentary evidence in the form of a telegram sent to me from New Haven, and a pawnbroker’s ticket which I redeemed. Miss Beauchamp, being unable to discover the whereabouts of her missing property, decided that she would go to New York to earn some money for the purpose of paying back that which had been borrowed. Thereupon B IV wrote a letter to Jones, telling him of B I’s intention. At this point in the narrative, Sally paused meditatively, and remarked that the ‘Idiot’ seemed to know some things and not to know others. How she knew that Miss Beauchamp was going to New York Sally could not understand, but ‘anyhow she did.’<sup>1</sup> The reply from Jones was received, not by B IV, but by Miss Beauchamp, who was distressed that Jones had been informed. Jones wrote that it was not safe for her to go alone to New York, and that ‘Anna’ must go with her as chaperone. Now this was just what Miss Beauchamp did not want. So, to shorten the story, after much difficulty she managed to give ‘Anna’ (who had joined her in Boston) the slip, and took a different train from the one intended. For some reason [which my notes fail to give] she took tickets to New Haven, instead of to New York. On arrival at New Haven, she went to the Young Women’s Christian Association, and applied to the matron for work, saying she knew only writing, reading, and that sort of thing. The matron

<sup>1</sup> Sally pondered upon this for some little time. It was probably an example of what was occasionally observed, namely, sort of memory-flashes from B I’s mind into that of B IV. They were generally merely isolated facts which B IV got hold of. Phenomena of this kind are well known psychologically, and are based on established laws. These scrappy memories used to puzzle Sally. Later, B IV devised a method of awakening memories of B I’s life. The whole was an interesting study, although made difficult by the fact that at first B IV would give no assistance. The phenomena will be later discussed (Chapter XV).

asked if she could wait on table. Miss Beauchamp thought she could, although she had never done it. So a place was obtained for her at a hotel on — Street, kept by a Mrs. S. Her stay here lasted about two days, and was varied by the ‘Idiot,’ Sally, and Miss Beauchamp coming and going, each bobbing in and bobbing out in the most confusing manner. Sally described the whole adventure and the different scenes in detail with a great deal of gusto and volubility, speaking so rapidly that it was difficult to follow her, and seeming to enjoy the complications that ensued, and the different things that befell the different personalities by the unexpected events thrust upon each. All went well until the ‘Idiot’ suddenly appeared and found herself waiting upon table, a position which she looked upon with the utmost disgust. Nevertheless, angry and disgusted as she was, she went on doing the work for a time. Then Miss Beauchamp and Sally would each come in turn. ‘I did n’t like to work either,’ said Sally, in a tone of superior virtue, ‘but I did it. B I did n’t like it, but did it because she thought she could earn money. The “Idiot” lost her temper,’ Sally continued, ‘and stamped her’ foot at the elevator boy. She has a nasty temper.’”

To digress for a moment: the difference in the mental attitudes of the different personalities towards the position in which they were placed is psychologically interesting. The attitude of B I was that of penance, of meekness, and of resignation to a duty to be done and for which all personal feeling was to be sacrificed. Her self-respect and honor compelled her to do it. That of B IV was rebelliousness, unwillingness to acquiesce in the conditions which she found, or to accept what was distasteful. She awoke to find herself in a disagreeable situation, without knowing the why or the wherefore, a situation not of her choosing. She saw no good reason for it, and rebelled. Sally alone found amusement and variety. To her it was at least adventure, which she loved, and she was able to enjoy the discomfiture of the others.

“ Finally the ‘ Idiot ’ would n’t stand it any longer, and went to Mrs. S., telling her she did not like the work and was going away. Mrs. S., who liked Miss Beauchamp very much, said she was very sorry, and tried to persuade her to stay — but not being able to do so, told her if she would wait till Mr. S. returned, he would pay her. But the ‘ Idiot ’ would n’t; she said she did n’t want the money anyway, and left then and there. Regardless of her finances, she ordered the elevator boy to send for a carriage; she wanted one, and at once. No carriage appearing at the end of two or three minutes, she turned upon him in a rage, and stamping her foot, told him she wanted a carriage ‘ at once — *at once.*’ At the station, after paying for the carriage, she found herself with only a little silver, less than a dollar, in her pocket, not enough to pay her fare. Then followed a period of deep thought and a walk through the city, believing that if she could think hard enough [as she afterwards told me] she would find a way out of her dilemma. The solution came. She pawned her watch for four dollars, and returned to Boston. When Miss Beauchamp (B I) later found her watch gone, she was much distressed, because it belonged to Miss Z. Now, in addition to the loss of her money, she had lost another person’s watch. Her trials had indeed multiplied. Thanks to Sally, the watch was located in the pawnbroker’s shop, and later I redeemed it. It is only fair to the ‘ Idiot ’ to say that she had a right to keep the watch if she so chose, having, unknown to Miss Beauchamp, exchanged her own for it, and further she had the pawnbroker’s card carefully preserved. After the return of the family to Boston, Miss Beauchamp (B I) in her turn waked up to find herself in a strange lodging-house-on — Street, which Sally claimed the honor of selecting in the following simple way: After arriving, Sally walked along the street, saw a placard in the window of a house, went in and engaged the room. Here they remained for some time, for Sally, to her credit be it said, showed considerable judgment in her selection.

“ Notwithstanding Sally’s enjoyment of the details and complications of this adventure, she was evidently frightened at Miss Beauchamp’s condition, as is shown by the letter which has just been given. Miss Beauchamp, harrowed and worried

by it all, was ready to give up the fight, and had tried to commit suicide. One night, soon after returning to Boston, she had closed tight the windows of her room, turned on the gas and got into bed, but Sally — again a guardian angel — immediately got up, turned off the gas, opened the windows, and thus saved her life. The attempt at suicide evidently impressed Sally, who pondered upon it awhile and then asked me whether, if Miss Beauchamp killed herself, she, Sally, would be dead too. On learning that this would be the case, she shuddered, and said, ‘I should n’t like that.’”

It was plain that Sally had conceived a dislike for the “Idiot” just as she had for Miss Beauchamp, but her dislike was more of the nature of contempt than hatred. She described the “Idiot” as irritable, bad-tempered, and given to telling lies, — the last a rather uncharitable interpretation on Sally’s part of B IV’s unwillingness to confess ignorance of the past, and her pretence of knowledge. These were great sins in Sally’s eyes. Sally was of the opinion that B I and B IV were in some obscure way the same person, and later used to speak of B IV as B I “rattled.”

At this same interview an opportunity was offered to observe B IV and to study the crystallization of her personality after the summer’s experience. These observations of her personality have already been incorporated in the text (Chapters XI and XII). It was to be expected that, by this time, an adjustment of her mental processes to her environment would have taken place, and that habits of thought would have been established.

“This is the way B IV made her appearance upon the scene : [After Sally had told her story B I was awakened again.] While talking with Miss Beauchamp, who had been relating her woes, the expression of her face changed; the anxious, depressed look was gone; her voice became deeper, and at times low and hard in contrast with the soft, high-pitched tone of

Miss Beauchamp. The change was puzzling. I wondered whether it was B I, calm and peaceful, or Sally, masquerading as B I.

“ ‘Well,’ I said, ‘Who are *you*?’

“ ‘I’m Miss Beauchamp.’

“ ‘No, you are not.’

“ ‘I think I may be allowed to know my own name.’

“ Her tone was reserved, as if resenting an impertinence, and very different from that of either B I or B III.

“ She rose to go, and walked toward the door. Taking her by the wrist, I attempted to lead her back to her seat. This she resented as a familiarity, which neither B I nor B III would have done. Apparently it was neither of these personalities, but B IV, whom I had not seen since June. I took her in hand at once for a rigid examination that should test her memory and character. In appearance she was calm, quiet, dignified, and natural. Testing cutaneous sensation, it was found to be normal, thereby distinguishing her from Sally. Mentally she appeared a normal person, but was more formal and distant with me than were B I and B III, more like one not on terms of intimacy with her interlocutor. She did not know the amount of money in her hand, or how she became possessed of it; how she happened to come to my house,<sup>1</sup> or how she got there; but she prevaricated, dodged, and tried to cover her ignorance by evasive replies. By pushing home the questions, it was easy to convict her of ignorance. She admitted the New Haven escapade, and gave her side of the story, though surprised at my knowledge of the affair. Though she tried to preserve a reticence about her affairs, my fuller knowledge of them gave me such an advantage, that in questioning her, she furnished considerable information. She said that she felt at times ‘as if possessed’ (Sally thought this a mere figure of speech), and that often she was prevented from doing things she wished to do. She wrote letters and tore them up again, or ‘some one did.’”

I have often been asked concerning the frequency with which the characters would change their parts in this drama, and the length of time each would remain on the

<sup>1</sup> B I had come by appointment.

stage. Any one of the three might remain any length of time, from a few minutes to several days, though as a rule many changes were made in a day. In the course of an interview of an hour, the personalities would perhaps change several times, though often this was brought about intentionally for purposes of study. During the interview just described, lasting probably two hours, the following was the order of appearance of each character :

B I; on entrance.

B III; spontaneous.

B I; brought intentionally by suggestion.

B IV; spontaneous.

B III; spontaneous, in place of IV.

B I; intentional.<sup>1</sup>

The following letter from B I is more than amusing. It is one of Sally's little jokes, but it has a psychological interest in showing the power of an inner consciousness to act upon the primary consciousness; that is to say, it exhibits not only the synchronous action of two consciousnesses and two *wills*, but the action of one upon the other. The letter may be recognized at once by its style of expression and thought as B I's, but Sally's fine hand is seen in the transposition of the letters in the individual words so as to make what looks like a sort of cipher language. B I wrote the letter, as was later learned, but Sally, *while B I was writing it, transposed the letters in B I's mind* (Sally of course, being "inside"), so that B I wrote the words as thus dictated. It will be observed that the letters of each individual word are correct; they are only misplaced. This required considerable thought and will on Sally's part and gives a clue to the extent of the field of her consciousness when she is "inside."<sup>2</sup>

<sup>1</sup> Appendix B.

<sup>2</sup> Sally described how she did this. Her statement is of value in throwing light on the way we think and use language. Since discovering her power, she has frequently mixed up Miss Beauchamp's writing.

[Letter of October 17, 1899, from B I; letters of each word transposed by Sally acting as a subconsciousness.]

“I spoek revy hastyli and unavdisdely tadoy in prosiming to sden yuo *lal*<sup>1</sup> Sally's nesto. I catnon. I cloud ton sden meth ot nay eno. And sa orf ym thero presimo atoub mocing ot rouy ofceif if I vahe anthero seegi wiht my deah ti si learly ipossible orf me ot peek taht oto. phlsycialy ipossible. You wonk I naect tindisshguisnight a tofo waay and naect klaw arcross the moor vase with the treagest tidyfculf I shodlu ton dear skir gniog ton of roods. I ma rorsy fauwly, rorsy you shodlu veah enve blotrued tabou it sthi meit. I idd ton mared of Mrs. — lephthenoing you orn idd I wonk yangthin tabou it niltu treafward.”

[Translation.] “I spoke very hastily and unadvisedly to day in promising to send you *all* Sally's notes. I cannot. I could not send them to any one. And as for my other promise about coming to your office, if I have another siege with my head it is really impossible for me to keep that too — physically impossible. You know I can't distinguish things a foot away, and can't walk across the room save with the greatest difficulty. I should not dare risk going out of doors. I am sorry, awfully sorry, you should have been troubled about it this time. I did not dream of Mrs. — telephoning you, nor did I know anything about it until afterward.”

Sally had been threatened with a sanatorium as a punishment for her behavior, and had been put on probation. She promised reform and agreed to wake up Miss Beauchamp whenever the latter relapsed into herself or B IV. Hence the following letter in fear of being suspected :

“I am in for another wiggling, I suppose, for She's vanished again and is n't to be gotten hold of, though I've tried three hurdy-gurdies and an organ-man and an ancient piano — and virtue is n't its own reward, for in spite of all this I feel as guilty and as unhappy as possible to-night. But I am

<sup>1</sup> Note the italics, indicating that B I thought she had written *all*.



sending you the card you wanted and my new address, — Street.<sup>1</sup> I hope you won't be *very* cross with me. I really have n't done anything, and have written only three letters — this to-night to you, one yesterday to Mrs. —, and one to-day to Miss —. If I were to learn French, and sleep a great deal . . . would you let me stay? I don't see why you all disapprove of me, — why you all think me just a psychological phenomenon. I can't understand."

The idea of learning French had come to Sally as an inspiration. In spite of her hatred for study she set to work to learn the language. If she only knew French perhaps we should think her quite as much of a person as B I or B IV, and perhaps we would let her stay. So Sally got a French book and a dictionary and plodded away on her road to culture. But her career as a student soon came to an untimely end. She appeared one day, stuttering badly and in bad temper, but very funny.

"Everything is just upside down," she complained. "The Idiot has been laughing at my French, and I c-c-can't t-t-talk to-day, and I c-c-can't feel things."<sup>2</sup>

She pouts and flounces about the room in a most amusing way. I tell her she is now catching it in her turn, but encourage her to go on with her story, which is a long one. The Idiot, it appeared, had picked up some notes written by Sally and had laughed at the French. Sally became angry, and the Idiot paid for her indiscretion. That night she (the Idiot) could not leave the house, but, a lonesome prisoner, she passed a weary evening in a chair, with her feet perched high up on the back of another. "She looked just like an actress," said Sally, "and was so angry because she could n't go out. She could n't get her feet down."

<sup>1</sup> The house selected by Sally after returning from New Haven.

<sup>2</sup> It will be remembered that Sally could recover sensibility by auto-suggestion.

[From B I, September 24.] "You are very good, but there is little I can tell you, for I have lost most of the time since the evening of the twelfth [12 days], only coming to myself for a few hours on Friday last, and again this afternoon. I am quite well physically, save that I have a bad headache, and am *awfully* tired and sleepy — my usual condition after one of these attacks, you know. As for my sins, I can't confess yet, for I am still in ignorance concerning them. I really do not know what I have been doing this time. It will 'out' soon enough. There is a perfectly tantalizing heap of thirteen envelopes on my table (received since I was last here), from which all the letters have been taken, and I suppose that means trouble and confusion sooner or later, but I am almost too tired to care. I thank you again — a thousand times — for your patience! It must be awfully hard for you. I do realize it, and that I ought to fight this thing out alone, and yet it seems so impossible to do it. I *have* tried, believe me."

To this there was appended the following postscript, "A nasty old letter — Amen," by Sally, of course.

Here are three letters written by Sally to Miss Beauchamp, and one from the latter enclosing them:

[Sally to B I.] "I shall never forgive you last night's madness — never, never, never! But it has settled one thing at least, and that is my having anything more to do with you. I disown you absolutely, forever, and entirely, and you may go to the devil in your own sweet way, for all me. I give you a week to get there — oh, no, less than that, if your friend the Idiot assists, much less. You shall call for me *then*, but I will not hear you. I will not answer.

"P. S. I shall not hinder you in anything, neither shall I help you. Go your way."

[Sally to B I.] "Do you know what I shall do if you don't write me about the three farthings man immediately, as I asked you to? I shall put a little, creepy, gray mouse with cold feet, and a long, long, twisty tail down your back, and fasten

him in so he will bite you. Consider this, little sister mine, and hump yourself. You don't half appreciate me — not half."

[Sally to B I.] "*You do like 433.<sup>1</sup> You think it's perfectly delightful here, and you are going to stay all winter.* Please commit this text to memory, ragazza, for you've slipped up twice within twenty-four hours, and my patience is fast vanishing. Don't make me write about it again. I'm too busy."

[Letter of October 11 to me from Miss Beauchamp, enclosing the above three notes from Sally:] "This note [No. 1] has made me so uneasy. But it is absurd, is n't it, for how can one disown oneself, how hate oneself, or how exult in one's own destruction, one's own undoing? It is madness to think of. Keep me from it, I pray you! I have not lost more than an hour or two since I left you yesterday, and have slept between six and seven hours. Were it not for my uneasiness concerning 'Sally' and the 'Idiot' I should feel quite well."

<sup>1</sup> The number of the house which Sally had selected after the return from New Haven. Miss Beauchamp did not like the house.

## CHAPTER XIII

### THE BIRTH OF B I, "THE SAINT"

IT will be easily understood from what has been said in the last chapter that B IV, by her coming and going, constantly found herself in awkward situations. She would suddenly appear out of the nowhere to discover herself in familiar conversation with an apparent stranger, who would refer to events of which she knew nothing; or she would receive letters in reference to engagements or past occurrences of which she was in entire ignorance. Many embarrassing predicaments were the consequence. It required all her mental ingenuity to keep posted on the doings of B I; or rather, to state the fact from her point of view (for she knew nothing of B I as a personality), on that part of her life when she herself was absent. As we shall later see, she had several methods of getting this information; one was by visions. She discovered that by "*fixing her mind,*" as she called it, she could create a vision of almost any event in which she had taken part, either as herself or in those blank periods of her life when she was B I. These visions were similar in character to the crystal visions which used to be obtained with Miss Beauchamp for purposes of experiment. Unlike Sally, therefore, both personalities were good subjects for these phenomena. The process of "*fixing her mind*" consisted in thinking intently, to the extent of absentmindedness, on any subject upon which she wished information, and if it was a scene in which one or other member of the family had played a part, the whole would rise before her like a panorama.

I sometimes took advantage of this, as I did with B I, to learn additional facts about her past life. I never knew a vision to be in error in the slightest detail, about facts of which I myself had accurate records or personal knowledge; yet a vision, when reproducing a past experience, must represent the scene as the subject saw it, not necessarily as it was. The reliability of the evidence must therefore depend on the accuracy of the subject's observations. When these are perverted by emotion, the vision must exhibit a corresponding perversion.

At this time, September, 1899, with a particular purpose in view, I sought to obtain a vision of the episode of the seventh of June last, when B IV made her first appearance. Without other suggestions of any kind, I directed B IV to "fix her mind" upon the event, and describe what she saw. She sat before me, her mind "fixed on vacancy." As she watched the scenes of the vision passing before her, the changing expression of her face reflected all the passing emotions which at the time of the actual events she had experienced. This is always the case with her as well as with B I in seeing visions. The feelings originally actually felt are re-excited. Sometimes she is so overcome that she breaks away from the sight. In interpreting this vision, it must be kept in mind that B IV *remembers* only that part of the episode in which she herself took part. She has no recollection of the scenes when B I and Sally were present. Hence her surprise at those portions of the vision. This was the vision (scene, her room: B I is present):

[Surprised and objecting.]<sup>1</sup> "I am not like that! I am not like that! [Shocked at the picture she sees of her other miser-

<sup>1</sup>In brackets are enclosed such comments as will render the meaning clearer. The words describing the vision are those of B IV, so far as I could write them down, — a difficult undertaking. Some of the statements were in reply to my questions.

able self, B I, she breaks off; then looks again.] I see myself walking up and down. [This was B I, agitated and nervous, and before my entrance.] You are not there.<sup>1</sup> Oh, my head! [Feels her headache as B I.] Oh, yes, I see you. It is n't the window; it is the door.<sup>1</sup> You are coming through the door. You take hold of my arm — so [illustrating]. You sit down. No, I can't hear what you say. Oh, Dr. Prince [annoyed and incredulous], I am not like that! [Referring to the great nervousness of B I.] You sit down, and I get up and walk back and forth. I am very nervous. I seem to be talking very fast. No, I can't hear what I say.<sup>1</sup> I am very much upset. It is Dr. Prince who is present.<sup>1</sup> I am all right now — not so nervous.<sup>2</sup> Why [surprised], Dr. Prince is gone! It is n't you. It is some one else — some one you don't know. [Stamps her foot, annoyed and angry.] It is Jones [this after much reluctance].<sup>1</sup> He is talking — talking. He throws himself back on the couch. Now I get up. I am standing, talking again. I get some scraps of writing paper — some blue, some white<sup>3</sup> — and a long square thing. He is talking and writing, writing, writing. He throws down the paper and tries to take hold of me. He does that [makes passes in imitation of hypnotizing]. I resent it strongly. He sits down again. He shows me his watch. He puts it back in his pocket, and takes hold of me again. I go like that [shuts her eyes, sways, rubs her eyes]. It is the same room. All is changed again. You have come back and are standing near the door. I am nervous again [B I]. You are gone.”

B IV, for a moment, was annoyed by the revelations of this vision, for she personally knew, and therefore remembered only that part of the scene which followed her own awakening and which ended with B I's reappearance. She still knew nothing of her different personalities as such; she knew only losses of time. Further, to see now a scene in which two other persons (Jones and myself)

<sup>1</sup> In reply to a question.

<sup>2</sup> Here B I has changed to B IV, with the illusion of my identity.

<sup>3</sup> For me to take notes on. See p. 172.

alternately took part—one changing into the other—was contradictory, and, as she could not understand it, annoying. The first thing of which she has conscious knowledge is Jones, sitting on the sofa and asking for writing paper, etc.<sup>1</sup> Irritated and perplexed, she exclaimed, "Who was there? [Stamping her foot.] Anyway, you couldn't both be there. *You* were there, then. Jones was there," etc., etc.

The theory, which arose as a suspicion soon after B IV's appearance, had been growing in strength until the idea had become almost a conviction. This theory was, it will be remembered, that B I was not the Real Miss Beauchamp, but that B IV was more nearly the true one; and that at some time in the past a psychical catastrophe had taken place by which a cleavage had occurred in the original consciousness, and B I had become split off as a quasi-somnambulistic personage; and that with the appearance of B IV there had been a return of or waking up of the original Miss Beauchamp.<sup>2</sup> It has been pointed out that other cases of this kind had occurred, and that of Rev. Ansel Bourne was instanced. The case of Rev. Thomas C. Hanna, studied by Dr. Boris Sidis, may also be cited. If it were not for interrupting this narrative numerous cases might be mentioned to give support to this interpretation. It was the simplest explanation. It was merely a question of evidence.

With this hypothesis in mind, all three members of "the family," as Sally used to speak of them, were inter-

<sup>1</sup> All the details of what took place while B IV was present, B IV recollects distinctly. Her memory is in entire accord with both my notes and the vision.

<sup>2</sup> It was difficult at this time to determine how closely B IV approximated the original Miss Beauchamp either in memories or character, owing to the fact of my being practically a stranger to B IV, and the consequent difficulty of obtaining her confidence. It was a long time before she was willing to disclose her consciousness to me.

rogated, in search of some accident or emotional shock which might have caused a split in consciousness. It was now for the first time that I learned from all three (Sally, B IV, and B I), and again later from B II, the secret which had thus far been closely guarded.<sup>1</sup> The stories of all three agreed in every particular, so far as the memories of each went. This is what was first learned from Sally:

It is necessary to go back six years to the year 1893. In 1893 Miss Beauchamp was a nurse in a hospital in a neighboring city—let us call it “Providence.” The passion of her life had been to be a medical nurse, and at last, in a fit of idealism, she had entered this hospital. One night, while in the nurses’ sitting-room conversing with a friend, Miss K., she was startled, upon looking up, to see a face at the window. It was the face of her old friend, William Jones, a man whom with the idealism of girlhood she worshipped as a being of a superior order. He was much older than she, cultivated, and the embodiment of the spiritual and the ideal. At first Miss Beauchamp thought the face a hallucination, but in a moment, seeing that it was a real person, she hastily got Miss K. out of the room, making the excuse that she herself was needed in the wards. As soon as Miss K. left, Miss Beauchamp went down to the door where she met Jones. It transpired that he had stopped over in Providence, en route to New York, and had wandered up to the hospital. Seeing a ladder which had been left by workmen) leaning against the side of the building, he had, in a spirit of fun, climbed up and looked into the window. At the hospital door an exciting scene occurred. It was to Miss Beauchamp of an intensely disturbing nature, and gave her a tremendous shock. Perhaps I should say here, as I have told so much of the story, that it was the kind of thing

<sup>1</sup> Sally told the story October 26; B IV, November 1; B I, November 3; B II, November 8 (1899).



which upon the ordinary person would not have had much influence — though it was of an emotional character. Miss Beauchamp, with her sensitive and idealistic nature, probably exaggerated its meaning and gave it an intensity that an ordinary person would not have given. At any rate, it did give her a violent shock.<sup>1</sup> The surroundings, too, were dramatic. It was night, and pitch dark. A storm was passing over, and great peals of thunder and flashes of lightning heightened the emotional effect. It was only by these flashes that she saw her companion.

Miss Beauchamp returned to her duties much agitated. For several days she was in an excited state. She walked the wards by night, and, in the day time when off duty and supposed to be asleep, slipped out of the hospital and wandered about the fields. Then she began, according to Sally's account, gradually to change in character. She became nervous, excitable, and neurasthenic. All her peculiarities became exaggerated. She became unstable and developed aboulia. She grew, too, abnormally religious. In other words, she became changed in character, and has been changed ever since, "and Jones thinks so, too," said Sally.

It seemed that at last we had a clew, though as yet incomplete, both to the origin of the two personalities, B I and B IV, and to the puzzling behavior of B IV on her first appearance, June 7. If the hypothesis suggested — that B IV is approximately the Real Miss Beauchamp — be correct, then several things would be expected to follow at her awakening:

<sup>1</sup> The shock of this incident was undoubtedly intensified by Miss Beauchamp's nerves having been shaken earlier in the evening by a scene with a delirious patient. There was a terrific thunderstorm at the time. Miss B. was walking down a dark corridor, when suddenly, in a flash of lightning, she saw this patient running toward her. She was much shaken by the incident. (See Chapter V, p. 66.)

First, she would imagine it to be the same day of the year and the same time of day that it was when she "went to sleep" and disappeared. She would imagine the surroundings and circumstances to be the same, and the whole interval of time which had elapsed during her Rip Van Winkle sleep, between her changing to B I and her reappearance as B IV, would be a blank. She would tend to go on with the occupations she was engaged in at that time. This, then, would be the explanation of her awakening on June 7, the details of which are intelligible by this hypothesis. She had "gone to sleep" on that eventful night in the hospital and had changed to B I. Waking again, June 7, she thought herself still in the hospital, in the same room and on the same night when Jones appeared at the window. Under the influence of this general idea she interpreted her surroundings: objects became illusions; the room became that of the hospital; and I became Jones. (This creation of an illusion by the force of a suggested associated idea has been often brought about experimentally with B IV. B I's negative hallucinations in regard to the rings are of the same order.) Logically, she inferred that I had come in through the window, having seen me there a moment before. Her criticism of the impropriety of my conduct in coming to a hospital in that way was intelligible, as well as the criticism of my being there at all at that hour. Hence her remarks about the unwisdom of asking for her, even at the door, and her joke about my breaking my neck had a point, seeing that she thought the room was in the second story of the hospital. Even the reason for the illusion was apparent in the association of the several events. All this was intelligible by the hypothesis.

Secondly, if this hypothesis were true, B IV would have a perfect memory for her whole life antecedent to

the hospital episode; while all between that and her awakening would be forgotten.<sup>1</sup>

One point of psychological interest may be pointed out in passing. The disintegrating emotional shock occurred at the hospital door. The moment when the amnesia of B IV began was not as yet quite clear, but presumably the loss of memory went back farther, to the moment when she saw the face at the window. This is what is known as *retrograde amnesia*, and frequently follows accidents. The loss of memory goes back over a period antedating the exciting cause.

There still remained the testimony of the Idiot herself. This was not so easy to obtain. Her habit of pretending to know events that occurred during the times when Sally and B I were in existence has been already dwelt upon. This habit she fortunately has now (1900) given up to a large extent. In moments of contrition and friendliness she makes a clean breast of everything, but at that time she would not only audaciously insist that she had this knowledge, but would also maintain an obstinate silence regarding herself, to the extent of resenting every inquiry into her thoughts and doings. Every interview opened with tiresome sparring, which ended only when her defeat was crushing. She claimed to know everything — even what took place in my presence with Sally and B I. It was easy to mislead her, "fishing and guessing" only as she was, by deftly worded questions, and then when her foot was well in, spring the trap. Thus, it was not difficult, by examining her on events of which I had personal knowledge, to convict her of pretence, but it was not until com-

<sup>1</sup> I should point out that there was a curious hiatus in her memory. Though she remembered Jones's face at the window, she did not *apparently* remember that Miss K. had been present up to that moment, as shown by her denial in answer to a question. (See Chapter XI., p. 174.) Such freaks of memory are not uncommon in these hysterical amnesias.

pletely cornered that she would become tractable or admit that she did not know.

Sally disliked her almost as much as she did B I, and constantly harped upon what she bluntly called her "lying." While, strictly speaking, "lying" was the plain English of it, yet from B IV's point of view this was justifiable, in self-defence. The difficulty of getting the exact truth from B IV was increased by the fact that she did, indirectly, acquire some imperfect knowledge of the life of B I and Sally, by what her friends let drop, and by "fishing and guessing," as well as by visions. Occasional isolated memory pictures also would emerge out of the depths of B I's life, and pass into her own consciousness.<sup>1</sup> It was proved, however, that, aside from these memory flashes, B IV knew nothing of her life since June 7 as B I or Sally. Had she any continuous memory of Miss Beauchamp's life before the hospital episode, or of the six years intervening between that event and her awakening on the seventh of June?

To understand B IV's attitude of mind, as has been so frequently insisted upon, we must not lose sight of the fact that she could not appreciate that we really knew her intimately; and, when I stopped to think, I found it equally hard to realize that this person, whom I had known well for years (though as another personality), felt herself a complete stranger to me. It was equally difficult for me to assume a manner of formality and drop that of intimacy, and *vice versa*, from moment to moment as the personalities changed before me. Any other attitude than that of distant formality B IV resented.

It became essential that B IV's confidence should be gained. I waited patiently an opportunity, when she should show a conciliatory mood. One day, November 1,

<sup>1</sup> Never out of Sally's consciousness. See Chapter XV.

1899,<sup>1</sup> after the usual preliminary sparring, she broke down and confessed; apparently becoming tractable, frank, and repentant. In this mood she described the events of the seventh of June as they appeared to her at the time, and also described the hospital affair of six years before. My notes of her statement run as follows:

[*Notebook.*] "When she saw me on the seventh of June for the first time, she imagined she was in the hospital, and that I was Jones. She thought it was that same night, six years before, when she was sitting in the nurses' room and saw the face of Jones at the window. *She was unaware that these six years had passed.* She mistook me for Jones [by an illusion], and therefore thought that I must have come in through the window. This last was an inference, which she had made from the fact that she had seen me (as she supposed) *a few moments before* (instead of years) on the ladder, and therefore supposed I had entered in that way. It was (she imagined) the same night, and the ladder was there.

"As to the original adventure, it now seemed to her only about one year ago.<sup>2</sup> It was about one or two o'clock when Jones appeared at the window of the hospital. He had done it for a joke. (Here B IV drew a diagram of the room, showing the relative positions of the window, Miss K. and herself.) 'When Miss K. went upstairs I went into the ward because a child was crying. I stayed there a few minutes. I don't remember what I did, but I stayed on duty the rest of the night.'

"'Did n't you go out?'

"'No, I could n't go out. I may have gone downstairs.'

"'Did n't you see Jones again that night?'

"'No; I am sure.'"

Note the fact that B IV's memory of the event stops at the point where she went into the ward; that is, just

<sup>1</sup> See Chapter XIV.

<sup>2</sup> That is, instead of six years. B IV's reappearance was on June 7, 1899; therefore, since 1893 she had really had about five months' existence to date, November 1, 1899.

before the exciting interview. There was therefore retrograde amnesia, as suspected. She did not remember going downstairs. Her statement that she had not seen Jones again that night or the next day could not be shaken; nor could she say when she saw him again.<sup>1</sup>

“I now said, “‘Fix” your mind [for a vision], and see whether you saw him again that night.’ She looks straight forward and falls into a dreamy state. ‘I have got it, Dr. Prince. It is curious. I see there are two. No, I don’t get it.’ [Then, much agitated, and withdrawing from what she sees:] ‘No, it is impossible! No, it is not true! No, no, no! I see nothing true! I hear nothing!’ [She shrinks as if in great mental distress.] I urge her on, saying, ‘Look, you see yourself outside the hospital.’ She repeats again, ‘It is not true! That did not take place! I see nothing true! I hear nothing true!’ She continues denying and resisting. I insist, though she seems in mental anguish, as if re-enacting what is before her. She again ‘fixes’ her mind, and apparently follows a scene. ‘I can see two — [a pause.] No! I would tell you if what I see were true! We separate — [a pause.] No. I can’t tell you!’

“‘Do you see yourself?’

“‘Yes, I see myself.’

“‘With whom?’

“‘Jones; but not like himself. All is dark except for the flashes of lightning.’ She seems abstracted and answers dreamily: ‘It is not Jones at all, — his face is all drawn, and he is very much excited.’ Then, coming more to herself, ‘He was very nervous and excited — not like himself — and as I saw myself I seemed so, too. It was dark, and lightning flashes lighted up my face and his. I was frightened.’

“‘Where were you?’

“‘It must be outside the hospital door. I am absolutely sure it is not true. The vision is gone. It was all very horrid. I don’t like visions like that. It never happened. [Looking

<sup>1</sup> B IV has since stated that she has no recollection of meeting Jones again until the summer of 1899, that is, six years later; though Miss Beauchamp and Sally have seen him frequently in the last few years.

again.] I can't tell you more. No, I can't hear anything. Now, I see only the trees. He seemed perfectly mad. [She shrinks and shudders.] Don't ask me to tell you more; I can't!' [She moves her lips inarticulately, as if physically unable to speak (aboulia?) and I allow her to come to herself.]

"B IV says that she has had this same vision several times this summer, and that it was 'always the same,' which was 'queer.'<sup>1</sup> It had made an impression on her in her relations with Jones, as if something had come between them. She has no idea that the vision is anything more than a fantasy, or an experiment without any basis in fact; and I allow her to remain in this belief, for if B IV is the true Miss Beauchamp and is to remain in existence it would be unkind to awaken a distressing recollection of this kind.

"Sally now bounced into existence, highly excited, and began vehemently to contradict B IV's statement that the vision 'was not true.' 'It is true. It is true,' she exclaimed. Then Sally, *while thinking about the vision*, became sad, dreamy, and depressed; then suddenly changed back to B IV,<sup>2</sup> who said the vision had come again but that it was not true.

"As she was about to leave the room, she again changed to Sally, who, however, refused to give further details, for it was thinking about the vision, she said, which had brought B IV. I insisted upon Sally's thinking of the vision, though she objected and accused me of wishing to bring B IV. 'Think about it,' I persisted. 'Put your mind on it.' She became dreamy, as if half-hypnotized. I bade her tell more. She refused, shuddered, fought, saying she could n't and I must n't ask; 'I can't help telling!' etc. Here I desisted, feeling that her wishes should be respected.<sup>3</sup> It was evident — what I

<sup>1</sup> See Appendix C.

<sup>2</sup> This suppression of Sally, when dwelling in her mind on the thoughts of B IV or B I, has a significance which will be reverted to in another connection.

<sup>3</sup> It is only right to add that I am certain from what I have since learned that it was only the youth, inexperience, and extreme impressionability of Miss Beauchamp that allowed her feelings to be so wrought upon; and that a more experienced person would not have found sufficient in the interview to justify such an exhibition of emotion. Further than this, as I have pointed out above, such a vision represents a scene as it was originally seen by the sub-

wished to learn — that whatever occurred had produced a profound shock, and had left a horrible remembrance in B I and Sally.”

Summing up what had been learned, the testimony of Sally and of B IV was in agreement up to the moment of going into the ward, when the memory of B IV ceased. After that moment, the statements of Sally were corroborated by the vision induced in B IV.

There remained the evidence of B I and B II. Miss Beauchamp was, of course, in entire ignorance of what had been stated by the others, and therefore of the fact that I had any knowledge of the hospital affair. At first surprised and startled at my knowledge, she soon accepted the situation and told with complete frankness the whole story, just as Sally and B IV had told it, going into every detail, with such exceptions as she considered confidential, — a reservation the others had made also. She remembered everything that B IV remembered, and, besides, all that occurred after going into the ward, when B IV's memory ceased. Her memory was continuous for the whole episode. She confirmed Sally's statements, word for word, up to the point of her own change of character, of which she had no realization, although, of course, she appreciated the impairment of her general health following the shock.

She added, what I had not realized before, that what particularly distressed her was the fact that since that eventful night she had tried to break with the past, while Sally, by corresponding and making engagements, and thereby breaking the promises that B I made, was constantly putting her in false positions. This was the secret of her dread of Sally's correspondence.

The testimony of B II was not of so much value from

ject and therefore possibly perverted by the emotions experienced at the time. This should be said in extenuation of the other actor in the scene in case one is tempted to draw unwarranted inferences.



one point of view, because she necessarily knew all that B I and B IV said. From another point it was the most valuable of all, for she never quibbled or prevaricated or withheld information. She might be called the "soul" of Miss Beauchamp, so straight and true were all her thoughts and dealings. B II said the account was all true in every particular, and, at my request, repeated it again in detail.

Thus we have the testimony of all four personalities in agreement.

Our previously put questions, whether B IV remembered the whole of her life antedating the hospital episode, in 1893, and whether she had amnesia for the six years following, up to June 7, 1899, may now be answered, though the answers were not easily obtained. Searching inquiry demonstrated that B IV remembered the events of the first period as well as Miss Beauchamp remembered them; for those of the second period she had no more knowledge than she had of the present periods when B I was in the flesh. These six years were a blank to her. It is unnecessary to enter into the details of the inquiries establishing these facts. It would be merely a tedious recital of the events of her early life on the one hand, and an inability to mention any (excepting "mind-fixing" phenomena) belonging to the second six-years' period on the other. The observations, continued through the whole seven years covering the period of this study, corroborate these earlier determined data.

Putting together all the facts thus far learned which bear upon the development of B I and B IV, we are able to make the following historical summary, for which the evidence is conclusive: Miss Beauchamp was distinct as a unity, a single consciousness, up to the summer of 1893. At that time there occurred a psychical catastrophe which produced a disintegration of consciousness, by which her personality changed and she developed into B I.

B I retained all the memories of her youth, as well as of the accident which led to her development; and also, of course, of her whole life (that is, exclusive of Sally's entrances) during the six years succeeding the accident of 1893, that is, up to June 7, 1899. She also retained a memory of those periodical times when she had been in existence since the latter date. She differs from her original state in certain bodily characteristics known as neurasthenia, and in certain mental characteristics — instability and suggestibility — and, above all, in certain alterations of character. B I therefore remained the sole personality in existence for six years — to June 7, 1899 — when, owing to some cause thus far unknown, a hitherto unobserved personality was awakened, which in associations of memory reverted to a past period of life, namely, that which antedated and ended with the aforesaid catastrophe of 1893.

This personality (IV) apparently belonged to that earlier period, and remembered the events of her life up to a certain hour, namely, that just preceding the incident which caused the psychical shock, at which time her memory ceased. From that eventful moment this new personality had absolutely no memory of anything that occurred during the following six years, ending June 7, 1899. Since this last date she knows and remembers only the events that have happened during those interrupted periods when she herself has been in existence. Since her appearance she has been constantly alternating with B I and with B III.

The life of Miss Beauchamp has been a constant succession of independent mental states known as B I, B IV, and B III. B IV has known nothing of B I, and B I nothing of B IV, while Sally (B III) has had a knowledge of both the others, although her knowledge of each has differed in some important particulars. Thus B IV and

B I each has knowledge of the events which happened to the unaltered personality before 1893; but since the disintegration, each has been cognizant only of the events experienced by herself as a separate personality.

Such were the facts as they had developed up to November, 1899. But there remained one fact in the development of B IV which was as yet undisclosed. What was it that caused B IV to be awakened June 7? Thus far I had no inkling that anything had occurred which could have brought it about. But I became convinced that something must have occurred to reawaken B IV, — if that is the proper interpretation. As an inquisitor I set about the task, and closely interrogated B II, Sally, and B I. B IV, of course, could have no knowledge of any event of this kind, for she was then "asleep." After close questioning, B II told the following:

On the afternoon of June 7 Miss Beauchamp was in my office. After leaving she went to the Boston Public Library. B II had a vivid memory of this afternoon. She described accurately the people whom she saw in my office, and each succeeding event after her departure. She told the route she took in her walk to the Library, and the title of the book read after her arrival. At this point I put abruptly the question, "What else did you do there?" She became frightened, shrinking from me as one might from some horrible dream. Her features were expressive of mental distress, and she begged to be allowed to open her eyes. It was evident that something had happened. Finally, though hesitatingly, B II completed her story:

In the Library Miss Beauchamp, quite accidentally, so far as she was concerned, met a messenger who was the bearer of a letter from Jones.<sup>1</sup> The letter was couched in the same sort of language as that which he had used on the memorable night in August, 1893. The tone and

<sup>1</sup> Probably this had been arranged by Sally.

language of the letter recalled the scene of that night, bringing the whole vividly back to her. She became highly nervous and excited, and then and there had a vision of the scene in which she met Jones outside the hospital door. She could hear his voice speaking as he did then; and the whole — the letter and the memory — gave her a profound shock, agitating her as she had been agitated six years before. She was profoundly moved and upset. While in this condition of extreme agitation she went into the Newspaper Room and there had a hallucination. In large headlines in a newspaper there was the announcement of the death of a relative of mine. Miss Beauchamp either misread the name, or, more probably, through a hallucination, saw it as mine. Under this additional shock she returned home in a state of great nervousness.

The succeeding events of the day I knew. Her condition after reaching home was such that even Sally became alarmed, and, hoping to quiet her, scribbled the following note on a piece of paper:

“Are you mad? Dr. Prince is as much alive as you are. It is his father who is dead.”<sup>1</sup>

Almost immediately after her return home I was sent for. On arrival I found her as she has been previously described. Then followed the awakening of B IV, her mistaking me for Jones, etc. Undoubtedly, then, what had awakened B IV was the reawakening of the hospital episode by suggestion and association of ideas. Later Miss Beauchamp herself corroborated this story.

While B II was giving this account a characteristic inci-

<sup>1</sup> This note I have. The dramatic character of the situation is striking. Imagine a highly excited hysterical, rattled consciousness; besides this, another consciousness, calm and observant, taking in the scene, and finally, becoming alarmed about the consequences, writing a message to the first consciousness to correct its delusion. The second consciousness both recognized the delusion and clearly oriented the environment.

dent occurred. She began to repeat the Public Library letter verbatim, when suddenly her lips refused to speak. She was seized with aboulia. Sally had interfered, stopped her, and then came herself. She refused to allow her to tell more, but said it was all true.

Was B IV the Real Miss Beauchamp?

The first part of the document  
 contains a list of names and  
 addresses of the members of  
 the committee. The names are  
 arranged in alphabetical order  
 and each name is followed by  
 the street address and the  
 city and state. The list  
 includes the names of the  
 members of the committee  
 and the names of the  
 members of the sub-committee.  
 The names of the members  
 of the committee are listed  
 in the first column and the  
 names of the members of  
 the sub-committee are listed  
 in the second column. The  
 names of the members of  
 the committee are listed in  
 the first column and the  
 names of the members of  
 the sub-committee are listed  
 in the second column.

The second part of the document  
 contains a list of names and  
 addresses of the members of  
 the committee. The names are  
 arranged in alphabetical order  
 and each name is followed by  
 the street address and the  
 city and state. The list  
 includes the names of the  
 members of the committee  
 and the names of the  
 members of the sub-committee.  
 The names of the members  
 of the committee are listed  
 in the first column and the  
 names of the members of  
 the sub-committee are listed  
 in the second column. The  
 names of the members of  
 the committee are listed in  
 the first column and the  
 names of the members of  
 the sub-committee are listed  
 in the second column.

The third part of the document  
 contains a list of names and  
 addresses of the members of  
 the committee. The names are  
 arranged in alphabetical order  
 and each name is followed by  
 the street address and the  
 city and state. The list  
 includes the names of the  
 members of the committee  
 and the names of the  
 members of the sub-committee.  
 The names of the members  
 of the committee are listed  
 in the first column and the  
 names of the members of  
 the sub-committee are listed  
 in the second column. The  
 names of the members of  
 the committee are listed in  
 the first column and the  
 names of the members of  
 the sub-committee are listed  
 in the second column.

**PART II**

**THE HUNT FOR THE REAL MISS BEAUCHAMP**





## PART II

### THE HUNT FOR THE REAL MISS BEAUCHAMP

#### CHAPTER XIV

##### IS NOT B IV THE REAL MISS BEAUCHAMP?

**O**N reviewing the results of our studies up to this point, it will be apparent that we are still far from being in possession of an adequate psychological explanation of the phenomena of multiple personality, as manifested by this case.

What has been shown is: 1st, the reality of a number of distinct groups of mental states in the same individual, and that these groups may be accurately characterized as personalities; 2d, the historical course of their development; 3d, the etiological conditions which gave rise to them, that is, the immediate exciting causes; 4th, at times, the coexistence and, autonomous activity of one particular (B III) with each of the others; 5th, the successive interchanging of each of the personalities. Finally the fact is worth emphasizing that each one, if not interfered with by the others or by the emotional shocks of her environment, might have monopolized existence and pursued her social life as any other freeborn citizen,—as B I actually did for six years. In other words, Miss Beauchamp, if not interfered with, might have continued indefinitely in any one of her states.

In dealing in general with the broad problem of multiple, or, more correctly, disintegrated personality, several

important questions await us, such as, What is a personality? Is there any particular normal real self? and, What are the psychological or physiological alterations which determine the division of personality and permit one and the same individual to have multiple mental lives? For the present, however, we are concerned only with the specific problems of this specific case, and of these perhaps the primary question at this particular epoch of this study was: Which of the personalities is the true and original Miss Beauchamp, or is any one of them she? If not, where is the real self? What has become of her? These questions had to be answered before the others could be solved.

It may be argued, and with force, that underlying this question of the Real Miss Beauchamp is that of whether there is any particular normal real self. It must be admitted that the question of what constitutes a normal and real self is fundamental to the understanding of multiple personality. "What constitutes a disintegrated self?" is the same question in another form. It is a very practical one, and enters more than is generally supposed into the every-day clinical problems of the psychoses. A want of proper consideration of this question has given rise in not a few instances, as I view the matter, to a wrong interpretation of the psychological phenomena of disintegrated personality. The conception has even been entertained that any one of the secondary states into which the original self may be broken up may be quite as normal as the original, and may be equally entitled to be regarded as the "real self." Indeed in specific instances the secondary self, or what has been supposed to be a secondary self, has been considered to be superior to the normal self. Thus, for instance, Binet describes the "secondary" state of Félicité X. as superior to the normal self, in that "all her faculties seem to be more fully developed and more complete."<sup>1</sup>

<sup>1</sup> Alterations of Personality, p. 9.

The suspicion does not seem to have arisen that the so-called secondary state may have been the normal state ; and yet this interpretation of the superior self's being a secondary one has come in not a few instances, as I hope to show in another place, from mistaking a disintegrated state because first observed, for the real self and the real self for a disintegrated state. The state which has been observed secondarily in time has been assumed to be psychologically secondary though it may well have been the normal state.<sup>1</sup>

Again, approaching the subject from a purely psychological point of view, it has been held that of the various possible selves which may be formed out of the "mass of consciousness" belonging to any given individual, there is no particular real or normal self ; one may be just as real and just as normal as another, excepting so far as one or the other is best adapted to a particular environment. If the environment were changed, another self might be the normal one. But the psychological point of view is too limited. What test have we of adaptation? There is a physiological point of view as well, and also a biological point of view, from which personality must be considered. A normal self must be able to adjust itself physiologically to its environment, otherwise all sorts of perverted reactions of the body arise (anesthesia, instability, neurasthenic symptoms, etc.), along with psychological stigmata (amnesia, suggestibility, etc.), and it becomes a sick self. Common experience shows that, philosophize as you will, there is an empirical self which may be designated the real normal self. However, I shall put aside this question for the present and assume that there is a normal self, a particular Miss Beauchamp, who is physiologically as well as psychologically best adapted to *any* environment.

<sup>1</sup> Besides the case of Félicité X., that of Marcelline R., reported by Dr. Jules Janet, and that of Mary Reynolds, republished by Dr. S. Weir Mitchell, may be cited as further examples.

This self should be free from mental and physical stigmata (suggestibility, amnesia, aboulia, anesthesia, etc.), which commonly characterize the disintegrated states making up multiple personality. Such a self may be termed the real self, in the sense that it is not an artificial product of special influences, but the one which is the resultant of the harmonious integration of all the processes, both physiological and psychological, of the individual. Any other self is a *sick* self. I shall return to this question at another time and in another place. Meanwhile I shall ask that this view be provisionally accepted, as I believe it will be justified in this case by the final outcome, and that it can be shown to be the correct interpretation of the phenomena of multiple personality.

In the hunt for the real self the greatest difficulty lay in deciding between B I and B IV. Sally, whoever she might be, was clearly not the original Miss Beauchamp, and not a normal person. All the evidence pointed conclusively to the view that Sally, by all odds the most interesting of the personalities, was some sort of a dissociated group of conscious states, and therefore the psychological explanation of this young lady was, to this extent at least, comparatively simple.

The explanation that first suggested itself was that which has already been given in the last chapter, namely, that Miss Beauchamp was a somnambulistic personage, and that B IV was the real and original self who had at last waked up. As already pointed out, persons to whom this has happened are not so very uncommon. Instances of this mental accident are chronicled from time to time in the daily press, and awaken more or less sensational interest. Besides the cases already cited in the last chapter, another and more recent case<sup>1</sup> is that of Charles W., who, after the

<sup>1</sup> Reported by Dr. Edward E. Mayer, *Journal of the American Medical Association*, December 14, 1901. This case in many ways resembles that of

shock of a railway accident, changed in disposition and other mental as well as bodily characteristics. Seventeen years later, as the result of another shock, he woke up with complete loss of memory for everything that had occurred during this interval, and found himself married and the father of four children! On waking, he thought the time was that immediately following the railway accident, and his first words were, "Am I much hurt?" When asked if he would like to see his children he exclaimed, "I am not married. It is a nice thing for a man twenty-four years of age to wake up and be told that he is the father of four children!"

While these studies in Miss Beauchamp's case were being pursued, another case of double personality, Mrs. J—n, came under my observation. Nine years before she had been subjected to a mental shock, and ever since had been in poor health and exhibited various nervous symptoms. Thus far she resembled B I. One day, while I was attempting to hypnotize her, she suddenly changed in manner, her attitude and mode of speech became different from what they had been, her symptoms vanished, her memory for the past nine years became obliterated, and she thought it was the morning of the day nine years before, when she had received the nervous shock. She thought she had come into the city to do some errands, as she had done on that day, and that she was now on her way home. This case disappeared from observation before I had a chance to complete my study of it, but I was struck with the resemblance of the new Mrs. J. to B IV, and the same question arose, Is it the original personality who has awakened out of somnambulism?

In respect to amnesia, Dr. Hodgson's case of Bourne, and

Miss Beauchamp, and possibly deeper study might have disclosed phenomena which would require the same explanation which was finally arrived at in Miss Beauchamp's case, instead of the interpretation given by Mayer.

Dr. Mayer's case differed, to be sure, from that of Miss Beauchamp. Bourne and Charles W. in their second states had no memory of their previous lives, while B I's memory was continuous for her whole life preceding the accident. But we have seen that amnesia is in no way an essential part of disintegrated personality. Sally indeed was without amnesia, if we limit our tests to the facts of conduct and external life and do not include those of the intellectual processes.

There was no serious objection, then, to regarding B I as a quasi-disintegrated somnambulistic person, in spite of the continuity of her memory. According to this hypothesis, the failure of B IV to remember the period following the hospital accident in 1893 might be classed as what is known as *anterograde* amnesia; just as her loss of memory for the short period intervening between her leaving the room and the emotional shock in the doorway, that is, for the period immediately preceding the shock, would be classed as *retrograde* amnesia. The former is called anterograde because it goes ahead of the emotional crisis, while the retrograde amnesia involves a period of time antedating the accident; just as a person who has received a cerebral concussion may lose all memory, not only for the accident itself, but for a definite period of time immediately preceding it.

Following this point of view, if we suppose that Miss Beauchamp had a severe emotional shock in the doorway of the hospital, we may also suppose that she only partially waked up after recovery from the emotion-psychosis, although seeming comparatively normal. In this state she may be supposed to have remained for six years, when she awoke completely as B IV, with anterograde amnesia for the preceding six years.

The somnambulistic theory, then, and the reawakening of the original person, in spite of the persistence of memory

in B I, was the simplest explanation of this strange case, and was in accord with what we know may occur in certain individuals of unstable mental equilibrium. There was nothing forced or unusual in this theory. But it must be borne in mind that this, though as yet only a working hypothesis, had already borne fruit in leading to the discovery of the hospital catastrophe and the scene in the Public Library. The hypothesis rested thus far on inadequate data, and on inferences. There was much to be said in its favor. It explained the various peculiarities of memory and behavior in B IV on her first appearance, and by it many peculiarities manifested by Miss Beauchamp herself became intelligible. Some of these latter phenomena were difficult to reconcile with a normal personality, even though neurasthenic. They plainly were the stigmata of hysteria, and if Miss Beauchamp was a disintegrated personality, as the hypothesis made her, she would be expected to exhibit them.

Among the most striking of these phenomena may be instanced: her aboulia; her extreme suggestibility in the waking state; her impressionability to her environment; the ease with which visions and negative hallucinations were created; the dissociation of consciousness by which another coexistent personality (B III) manifested automatisms; the mobility of her neurasthenia, exhibited by the rapidity with which it was induced by a passing emotion and removed by a suggestion; and finally, the way in which the ideas and emotions of the moment dominated her mind to the exclusion of everything else and acquired an intensity unusual in normal minds. The intensity of her religious feelings may be recalled in illustration of the last. Whether the very saintliness of her character, her absolute freedom from the petty weaknesses which characterize human nature, is compatible with a normal human being, I do not pass upon. I merely point out that no one

seems ever to have observed in her irritability of temper, rudeness of speech, retaliation for injury, jealousy, envy, or malice, which in some degree characterize stronger mortals.

Then, too, the hypothesis made attractively simple why B IV, on her first appearance, imagined that she was living at almost the exact time and place that she went to sleep, so to speak, six years previously. Her apparent health, also, both mental and physical, supported the hypothesis.

The chief obstacles to the verification of the hypothesis were: lack of personal knowledge of Miss Beauchamp's character before the accident of 1893; B IV's obstinate refusal to disclose her own present mental life, and Sally's ignorance of it. Sally chafed, too, at being obliged to talk psychology and "that kind of stuff," so that it was difficult to get much out of her. One day, however, she gave a flood of information regarding the personality of B IV, much of which has already been related in Chapters XI and XIII. Sally became for the moment serious and earnest, showing great intelligence and perspicacity in her analysis of the psychological and other facts. She discussed them with intelligence and interest, went over the history of the past year, explained many facts which were obscure, and recalled others which I had overlooked. Reference to my notebook showed that Sally's memory was correct.<sup>1</sup> Her theory of B IV, which she was careful to explain was only a theory, was afterward written out by her at length.

[*Notebook.*] "Sally prefaced her theory by saying with some diffidence that she did not know whether or not she was right. She thinks the Idiot like Miss Beauchamp as she used to be,

<sup>1</sup> The accuracy of Sally's memory was extraordinary, and would furnish a study in itself. I have known her to repeat word for word the contents of a letter written a long time previously, and she could remember the minutest details of incidents such as I could not possibly remember, but could verify by my records. It is also true that all the personalities have extraordinarily accurate memories for their own respective lives.



but not 'up to date.' She is like Miss Beauchamp as she was when a young girl about fourteen years of age, and 'Jones says so too.' [About years and dates Sally is not accurate, having very little comprehension of time; twenty years and fourteen would be the same to her.] She thinks the Idiot goes back mentally to about the time of the hospital episode, when she received the mental shock. She does not mean that to the Idiot it is exactly that time, but that she is living in her imagination at about that time, and has forgotten all between that time and now. 'Don't you remember,' said Sally, 'that she did not know you when she first came, and thought you had come through the window? She thought the time was that of the hospital affair. You remember she did n't recognize your office at her first visit here, and she only half knows you. She does n't know much about you. She goes back partly to old times, with a sprinkling of modern times; that is, she is always fishing and guessing, and what she gets from modern times she gets by suggestions from other people. When she is talking with Jones she almost invariably goes back to old times and speaks of them as if they were present. I think she has impressions as if she were living at that time. She *knows* it is n't years ago, but all the same she talks hardly at all of things that have happened between, excepting when people suggest to her events that have happened since.'"

Sally then went on to illustrate her views by recalling various facts, such as that the Idiot had referred to Mrs. X. by her maiden name, Miss D. (Miss D. had been married since the hospital affair), that she kept calling Dr. Hodgson Dr. Y., some one she had known in Providence, and that she had written Jones two letters (destroyed by Sally) referring to hospital times as if she were still living in them, etc.

"She knows," Sally argued, "everything relating to the present that has occurred while she herself is in existence, and guesses from what she sees and hears about the times when she is 'dead.'"

The rest of Sally's statement may be briefly summarized

as follows: B IV and B II were not identical because she (Sally) knew the thoughts of B II but not of B IV; B IV never appeared until June 7; B II knew all about B I while B IV knew nothing of her; B II had no spontaneity, but confined herself simply to answering questions like a person in hypnosis; and the Idiot was without the maturity which the last six years' experience, if she had had it, would have given her.

In other words, according to Sally's idea, the problem was very simple: B IV, the original Miss Beauchamp (as she was before the nervous shock at Providence), now waking up, after a six years' sleep, had not as yet become accustomed to the changed circumstances in which she found herself. As all her associations were those of the year 1893, she went back in her mind to that time and spoke and acted as if she were living then. She was not actually under the delusion that she was living then, for she had learned the contrary, but her thoughts kept relapsing from time to time.

These latter statements were observations of fact about which there was no question. Whether the inference was justifiable that this personality was the original self was another question, and largely depended upon the determination of her character, and of her mental and physical qualities as well as memories.

The question then, whether this personality was the original self or not, was of the greatest importance, for on its solution hung Miss Beauchamp's fate. Plainly, if B IV were the real self, she must be kept and the others annihilated. Poor Miss Beauchamp, the saint, whom we knew so well, whom we had protected and cared for, would be only a dissociated personality, a somnambulist, and must no longer be allowed to live. This person must never be seen again. Every friendly association must be broken as through physical death. But how obtain the

evidence sufficient for proof? Here were two people, either of whom might be the real self, while there was no reason to suspect that there was any other personality not yet known. Which was the real one? The only way to solve the problem was to study the personalities day by day; to follow every thread of evidence; to study the characteristics, the habits, the memories, the thoughts, the mental reactions of each; to determine which personality was comfortable with abnormality and which with normality, and so find the real self; then, regardless of personal associations, annihilate the other.

The difficulty of understanding the Idiot is illustrated by the fact that even Sally, upon the very day she elaborated her theory, began to wobble a bit in her opinion.

“I am sending you the letters,” she wrote, “the spooky message,<sup>1</sup> and also some objections to my theory concerning the Idiot, though I am afraid you know all about her and have only been teasing me to-day. But if she really is Miss B., why is she so unlike her in some ways; for instance, in being so awfully impatient and quick-tempered? Miss B. never was. And in telling lies, and forgetting, and all that sort of thing — that is n’t like Miss B. really, not in the least — nor even like me, bad as you all think me. And then she knows some things that we have acquired recently, as shorthand, though I believe she fishes for her shorthand in some such way as she does for other things. But you know best. Do let me help you, if I can. I never dreamed of all this stuff making any difference, or being of any real interest in your work, — and even now I don’t quite see its importance? But I will tell you everything I can, nevertheless, and if you won’t please criticise the . . . letters, perhaps I may get them or copies of them for you. Shall I, or are they too old now?”

These objections could not be taken too seriously. All the departures noticed by Sally from Miss Beauchamp’s

<sup>1</sup> Some automatic writing.

former habits of thought and conduct could be logically explained by the change of times, circumstances, and conditions in which she found herself. The saintliest of characters might find a justification in prevaricating and fibbing if she should wake up after a six years' sleep to find herself in a strange land and among strange people, who not only had an unaccountable familiarity with her life, but were constantly inquiring into and managing her affairs and herself. Such a saint could hardly be expected to be patient under the surveillance of a stranger, or to submit to it without remonstrance. If there were some old acquaintances as well as strangers, times had changed and B IV could not be expected to realize the change in her relations to former friends thus brought about. Also, Sally did not know what B IV really thought, so her moral criticisms, which, after all, were made from the point of view of a child, could not be taken too seriously. She was shocked as a child might be.

A psychological objection to B IV's being the Real Miss Beauchamp lay in the very fact that Sally did *not* know her thoughts, as she knew those of Miss Beauchamp before 1893. But it might be argued that some internal modification had occurred, and it did not seem safe to lay too much stress upon this fact.

One day (November 1) I took the Idiot into my confidence and explained what we were trying to do to help her, her relations to her new friends, how it had come about that she was under professional care, and some things of her past life which were unknown to her, *but nothing of the hospital accident in 1893*. Confidence begets confidence. She listened intently to the story which made clear the conditions in which she had found herself mysteriously placed; the fact, previously incomprehensible, that we were not strangers, but friends of long standing; and finally, the motives of those of us who were interested

in her welfare. It all came to her as a revelation, and she seemed deeply grateful. For the first time she became candid, natural, and frank. Apparently desirous of coöperating in every way, *without knowing that I had already been informed by Sally (October 26)*, she told her side of the story of the episode of June 7 (already narrated),<sup>1</sup> and gave a full account of her childhood up to the eventful evening in the hospital in 1893. Of this early life she exhibited a complete knowledge up to that date. Now for the first time she admitted the periods of amnesia which had been proved against her over and over again, and explained her apparent knowledge of these periods. It came from, first, what had been told her, and guessing and inferring (she has learned from friends that she was lately taught shorthand, and is thus able to account for her knowledge of this subject); second, occasionally from certain things coming hazily and unconsciously into her mind out of the nowhere, without connection with anything else; third, from voluntarily producing visions; and fourth, from "fixing her mind." She gave an exhibition of the last method. Her knowledge of her life in college, relatively meagre as it is, has been supplemented by frequent references made to it by her friends.

In all these ways she has artfully gained considerable knowledge of certain blank periods in her life; enough to convey to an ordinary observer the impression that she knows all. B IV — she can no longer be called the Idiot — further very frankly explained her motives for not admitting her ignorance. She thought that she would veritably appear as an "idiot" if she seemed not to know about herself. As most of her present acquaintances, including myself, are strangers to her, she is reticent about confiding

<sup>1</sup> This was the occasion described in Chapter XIII, when IV corroborated Sally's statement, and had the crystal vision of the scene outside the hospital door.

her affairs to them. It was difficult, she went on to say, to realize that I knew her well, and she found it hard to accommodate herself to this idea.

As B IV told her story, her whole line of conduct seemed consistent with rationalism from her point of view. It is worth while pointing out here that the accuracy of B IV's statements was shown by the fact that frequently when my memory of the events (which I knew about personally) was at fault, B IV corrected me, and always rightly, as shown by my records. B IV herself, at a later period, analyzed her conduct in a way that gave it a rational interpretation.

"I am afraid," she wrote, "I can hardly analyze my conduct toward you. It has depended partly on my own mood, and partly on the spirit in which it seemed you met me. I disliked exceedingly your assuming such control over me, as if I were indeed as helpless as I felt. And I disliked, too, your continually calling me to account for things I had said and done — things I could not possibly remember at the moment, with your 'eagle eye' fixed upon me. You had me at the greatest disadvantage always — a disadvantage which should have taught me humility and a becoming submission, I suppose. But it did not. It simply annoyed and irritated me, and made me determine not to give in to you. I thought you could not *know* the things you asserted, while practically every one else was ignorant of them. Your assertions must be founded on the same bases as my own, and they were worth no more. I would deny everything, defy you, and fight it out. And in doing this I quickly saw that, to a certain extent at least, I was right. You were puzzled. You half believed what I said. And so I kept on. Does this make it clear to you? Rather a disgraceful confession, is it not? but you would have it. . . . I believe — I do, really — in spite of the preceding, that once upon a time I used to be almost morbidly conscientious in regard to the truth, even refraining from the use of many conventional, every-day —"

This was unfinished, as if at this point she had changed to Sally — a common experience with the two superior members of the family.

B IV was so natural and simple during the interview which has just been described, and explained her point of view so logically, that the hypothesis that she was the real and original self gained greatly in favor. The evidence for this view had become exceedingly strong. From the data thus far accumulated it seemed fairly certain that she was the real Miss Beauchamp, and therefore, if we were to bring about a cure, must be made to stay, while the Miss Beauchamp who up to this time had been the object of our care, had been educated in college, had been the solicitude of many friends, who belonged to a circle in which she was literally beloved and respected by every one with whom she was brought into close contact, — this Miss Beauchamp was not, properly speaking, a real person, but a dissociated personality, a quasi-somnambulist, rightfully distinguished as B I. She must be made to disappear, to go back into the unknown whence she came. This, under the hypothesis, seemed to be the hard logic of events.

The situation was a dramatic one. If one pauses to think over all that this meant, and to apply it to oneself (for each one of these personalities is as individual as any one of us), one can realize the full meaning of the verdict that a self, with all its memories, feelings, and sentiments, must be annihilated. It was the annihilation of the individual.

The evidence seemed to be sufficiently strong to justify the hypothesis being accepted, provisionally at least, and B I was condemned to be sacrificed. So all therapeutic effort was directed toward extinguishing B I and keeping B IV in existence. As a matter of fact, during the summer and autumn the new character had tended spontaneously to keep more and more in existence, while Miss Beauchamp receded correspondingly into oblivion. The

latter's discouragement grew as she found herself, notwithstanding improved physical health, apparently relapsing mentally more and more. What we thought was a return to health (B IV) to her was increasing ailment. If the disagreeable job had to be done, the quicker and more thoroughly the better. So again and again by suggestion she was changed to B IV. Sally's coöperation was also secured; she agreed to extinguish B I as often as she came, and to transform her to B IV. So between us B I had but few moments of existence. It seemed to her, when she did come, that her malady was hopeless, and her discouragement became overwhelming.

After this had been going on for some time Sally, who was on her good behavior and in a helpful mood (in consequence of a threat to send her to an asylum), one day "folded herself up,"<sup>1</sup> fixed her thoughts upon B I, and as she did so a change came over her and Miss Beauchamp was in her place. At once the vivaciousness and gayety of Sally were gone, and in place of smiles and fun her face wore an expression of weariness and sadness. She was manifestly agitated. What was going on in her mind was plain: she had awakened to find herself in my office, without remembrance or knowledge of how she got there. The lights were burning, so that she knew it was late, and from past experience guessed that she had been there a long time — probably since early afternoon — and, what always troubled her, had absorbed a corresponding portion of my time. She had come to herself for the first time in several days, and the consciousness of the time she had lost, and of the increasing frequency of her relapses, showing that her condition was growing worse instead of better, — for to her the annihilation of self was increase of disease, — all this gave her a feeling of hopelessness which

<sup>1</sup> Sally's expression for putting herself into a state of abstraction and changing herself to B I or to B IV.



expressed itself in her face, in her voice, and in her every movement. It was impossible to explain that her extinction meant the growth of her true self, of whom she knew nothing.

As she sat before me, the embodiment of nervousness, unable to keep her body in repose a single second, trying to explain why she had come (which she did not know), apologizing for detaining me, and finally wearily telling, in response to my inquiry, her mental troubles, one would not have been human not to sympathize with and pity her. She told of how she was unceasingly losing time (what I was trying to bring about), until she knew almost nothing of the past week, of what she had done or what new responsibilities had been assumed. For the first time she missed the letters of Sally, for, stinging though they were, they at least kept her informed of how her days had been passed. Physically, she was a great deal better than she had ever been, and she could not understand why she was worse mentally. She had fought the fight, she said, and had done her best, but in spite of all, her trouble was increasing. To go on in this condition was impossible. It would trouble no one, she thought, if she ended her life, and she felt that she would be justified in doing so.

The most callous must have been moved by this pathetic figure, hopeless and dejected. As she talked, my mind went back over the events of the past two years. I remembered all that she had gone through—her trials, anxieties, and physical sufferings—and the unending patience with which she had borne not only the physical ailments, the sleepless nights and days of pain, but the false positions in which she was persistently placed, the constant misconceptions by friends of her character and actions, all unexplainable and about which she must be silent, the taunts and jibes aimed at herself in Sally's letters which she believed to be true, and the loss of pre-

cious possessions, to say nothing of the countless petty daily annoyances, like the destruction of the product of days and weeks of labor, — all this passed through my mind. The patience with which it had been borne showed a heroism rarely seen, even in the sick room. Though it might be that she was not her real and original self, she was as truly an individual as any one that ever lived. She had her friends and associations, equally dear to her. Now all her psychical life was disappearing, though what to her was only deepening mental trouble was really, as we believed, her salvation, the bringing of her true self. She could not be told this, however. It would be impossible for her to be satisfied with a cure which was self-annihilation; and not only the annihilation of self, but of her ideals and of every sentiment and thought she held dear. It would be useless to tell her that she would, though another character, still live, for that still meant the annihilation of all her associations and memories of the past six years. She could not understand who or what she was to be, and how could this be sufficient for life? It meant too that she would become a character of whom she highly disapproved, whose actions for months had caused her infinite distress, and whose conduct, as she interpreted it from her limited data, seemed to depart from the high ideals which she had set before herself. Such a character she could never reconcile herself to be.

In my thoughts the annihilation of Miss Beauchamp seemed in no way different from saying that she must be satisfied with death. It seemed hard to tell her that this annihilation was being purposely brought about. It seemed kinder to let her disappear, ignorant of her coming fate, unconscious of the future that awaited her as her Real Self. There would be less mental pain for her, — and yet, it seemed like a crime we were committing. It was a psychical murder.

Venturing tentatively to hint at the question of self-annihilation, I asked her whether she would be content to get perfectly well, at the sacrifice of all memory of her life from the hospital episode to the present time, remembering everything before that event, and from this moment on. As she thought about it she fell into a state of reverie in which she did not seem to hear my voice. Again her face changed: the expression of weariness and sadness vanished, and in its place was one of strength and self-reliance, as of one quite capable of wrestling with the world. When she spoke her voice too had changed, no longer expressing discouragement, but the manner and thought of a person in normal relations with her environment. The tone was natural, dignified, and indicative of self-confidence. The character of the personality had plainly changed. She had no shattered ideals, no intensity of sentiment, no discouragement from overwhelming obstacles, but, content with the conditions as she found them, she sought only to prolong her own personality. It was B IV.

B IV appeared to great advantage. Her conversation was most natural and rational in contrast with those previous interviews, taken up as they had been with tiresome debate. In extenuation of her habit of bringing visions, she said that this was the only practical way she had of informing herself of what had happened in her life, of her relations to other people and events. She then went on to explain the embarrassing positions in which she was constantly being placed. She would find herself in strange places without any idea of how she got there, talking to strange people, and in intimate relationship with persons whom she did not know. People talked to her as if she were familiar with things of which she knew nothing, and as if she had done things of which she was totally ignorant. She was thus constantly placed in embarrassing positions, and was afraid of appearing like an idiot if she

confessed her ignorance. Thus it was that she had got into the habit of fishing, inferring, and guessing; pretending to know things about which she was absolutely ignorant. She most frankly described how she quibbled, evaded, guessed, and jumped at conclusions which were often wrong. Thus the habit of fibbing had grown up to conceal her ignorance.

Believing that this at last was the Real Miss Beauchamp, I told her she was entitled to know everything, and in time should know all (meaning the phenomena of personalities). I then explained briefly that she had received a shock in the hospital at Providence (emphasis being put upon the fright from the lightning and from the delirious patient, though Jones was mentioned), in consequence of which she had changed, and that now, from time to time, she continued to change so as to lose and regain her memories. I explained the two personalities, B I and B IV, but said nothing of Sally or of the real shock. To this she replied that if this were all she was content to wait for a full explanation. She had inferred that there had been some terrible calamity which we were trying to keep from her.

No one, hearing the conversation and regarding her, could have recognized anything abnormal, or observed in B IV any characteristics other than those of an intelligent person. She was not discouraged, as was Miss Beauchamp; only annoyed at difficulties to be overcome. Her earnestness in telling her story was convincing. Finally she rose to go, apparently relieved in her mind, and ready to pursue any course essential for a cure. As she went out of the door she turned, and Sally's face smiled at me. "Rubbish," said Sally, and ran off laughing.

And it was "rubbish," in one sense. Although B IV spoke the truth, she was not the Real Miss Beauchamp after all; neither was B I.

## CHAPTER XV

### DISSOCIATIONS OF CONSCIOUSNESS: AMNESIA

WHICHEVER was the real self, B I or B IV, the other was a dissociated group of conscious states, and the memories lost to one were not destroyed, only dissociated; they reappeared when the proper personality awakened. But this knowledge in no way solved the problem. There was nothing for it but to make a study of the "Idiot." This study was continued over a period of several months, during which, against every obstacle, a fact here and a fact there were obtained, until, a large number being accumulated, each was fitted in so far as possible in its proper place in the psychological puzzle. Some of these data bore upon the hypothesis in question, while others threw light upon the individuality of B IV. Sometimes a paradoxical phenomenon would be observed, like that of the remembrance by the Idiot of episodes in the life of B I which seemed to controvert the apparently established amnesia. Only later, after some weeks of observation, would the explanation of the paradox be discovered in phenomena purposely concealed from me. This study, indeed, had been going on for some weeks before the secret of the Providence catastrophe was wrung out of the personalities, though the probability of some such occurrence had been suggested by the hypothesis itself.

Before these biographical details were known, the extent of B IV's memory, one of the most important questions to be solved, had already been determined.

This determination of memory may seem easy enough, but the inquiry was hampered, as already pointed out, by

two circumstances: first, IV's claim that she remembered everything; and second, the fact that she did get at certain isolated incidents in B I's career, a fact which was paradoxical, at least, and seemed to substantiate her claim. These latter phenomena, which proved in fact to be phenomena of abstraction, became a very interesting subject of study.

As to the first, it led to the tiresome sparring at every interview, and brought out the curious fact that, during the early months at least of her career, she was not wholly conscious of the gaps in the continuity of her memory corresponding to those times when B I and Sally were on the stage. One event seemed to slide into the next without regard to the interval of oblivion which really existed for times when she changed to one of the others. Still, this in no way exonerates her from the persistent, unyielding determination, like a defeated political candidate, to admit nothing and claim everything. Every interview was begun in this way. It was only by convicting her out of her own mouth of deliberate fibbing that, staggered by the evidence, she would break down, and confess the ignorance she exhibited. Then she would acquiesce and become obedient — until the next interview.

For instance: Sally or Miss Beauchamp, while conversing would change to the Idiot, who at once would be put through a rigid examination as to the events of the previous half-hour or so. You could almost see her mind working, as she first parried the questions, then fished, then guessed and inferred, all the time being led on to put herself deeper in the mire. Finally, when well in, she would be told the real facts, which, as they had occurred under my own eye, she saw there was no use in denying. Thus she always had to be beaten to a finish before she could be controlled.<sup>1</sup>

<sup>1</sup> In further corroboration of this ignorance were her actions, which were in entire accordance therewith. She was constantly getting herself into

The scrappy, fragmentary, and apparently paradoxical memory of the life of B I which she manifested was at first puzzling, particularly as it was difficult to determine how extensive this memory was. A study of these paradoxical bits of memory showed that they could be divided into three classes of psychical phenomena, which are of importance not only in solving the riddle of Miss Beauchamp, but in understanding the problem of multiple personality:

(1) those which were a spontaneous synthesizing with her own personal self of isolated fragmentary memory pictures belonging to B I; (2) those which were phenomena of abstraction; (3) those which were artificially induced visions, — so-called “crystal visions.”

These three classes differ from one another not so much in principle as in detail and process.

The first class comprised memory flashes which were perfectly spontaneous, uninfluenced by any volitional effort of her own. They were the emerging into her mind of isolated memory images, such as a name, a face, or a place, which seemed to come from out of nowhere, without any connection with anything else. These did not bring with them any extended associations and were unimportant so far as affording definite aid in adapting herself to her environment went. Finding herself speaking with an apparent stranger, for instance, the correct name of this person would flash into her mind, or the face of an apparent stranger in a street-car would suddenly become familiar, but there was nothing more extensive than this. Of this character was the recollection (?) and mention of my name on the evening of her first appearance, June 7. As she afterwards explained, the name came into her mind, but it

trouble, doing things entirely against her own interests, and, like B I, allowing herself to be the victim of Sally, — all in consequence of her ignorance of her other life.

might just as well have been Smith, Brown, or Robinson, for all that it conveyed to her.<sup>1</sup> (Appendix D.)

The second class of memory phenomena was due to an artifice which she secretly employed. It consisted in "fixing her mind," as she called it; or, more technically, using the process of abstraction in the same way that it is used for experimental purposes to get at subconscious ideas. A specific instance will give an idea of the way she employed this method and the results obtained:

On one occasion (October 20), to test the extent of her memory for the past, she was asked if she could remember the first time I saw her. I supposed that she would mention the incident of the previous June 7, the day of her first appearance. To my surprise, she described with accuracy the day when Miss Beauchamp, while a student in — College, for the first time appeared for a professional consultation, a year and a half before. She stated the various ailments of which Miss Beauchamp had complained, and the details of the prescriptions and directions given her, and *even described my clothes.*

"How long ago was that?"

"It was four or five years ago—I don't remember exactly." Tries hard to remember. (Note the inability to measure the time.)

"Through whom did you come to see me?"

"Through Miss D.—Mrs. X.—she was n't Mrs. X. then — Miss D." (Correct.)

Similarly, B IV described the New Haven escapade—at least, as much of it as belonged to B I and herself, but nothing of Sally's part. At first, her memory was very hazy, but *by taking her through each step in succession, and by allowing her to think hard* she recalled the events. On a previous occasion, before she used her "mind-fixing"

<sup>1</sup> Chapter XI, p. 172.



process, she could not recall this adventure. This memory, in contrast with her amnesia, seemed paradoxical.

Here was evidence of quite an extensive memory of the life of B I, showing apparently that the division of personalities was not as complete as previous observations had seemed to indicate. At the time, the contradictory evidence was puzzling. Later, she confessed the trick. When she appeared to the onlooker to be in deep thought she was, in reality, in a condition of abstraction.

She now demonstrates the device in my presence. She puts herself into a condition of mental abstraction, appearing partly oblivious of her surroundings, like a person in deep concentration of thought. She looks straight before her, fixedly, in the distance. She *sees* me, dressed as I was then, *hears* my voice and is able to reproduce the whole scene more accurately than she could possibly do by simple memory. *While abstracted, she fails to hear when spoken to.*

Later, I frequently caught her trying to use this trick. When prevented from falling into the condition of abstraction she failed to remember.

The third class of memory phenomena, that of visions, was similar in every way to the crystal visions which had been experimentally induced in Miss Beauchamp.

In the case of B IV, we know that the amnesia was not absolute, because the lost memories were retained in the mental life of B I. But suppose that B I had not reappeared after B IV's advent — should we have been justified in concluding that the memory of the previous six years had been obliterated for good? This phenomenon would have proven that the memories of B I's life were only dissociated, and that by a proper device they might be resynthesized. In principle, the amnesia of B IV and B I resembles in every way the hysterical anesthesia which has already been discussed, only that the amnesia involving large groups of memory experiences is more complex.

Some observations made by Dr. Boris Sidis and myself on the subject M—l,<sup>1</sup> already mentioned, may be cited in evidence of dissociation being the basis of hysterical amnesia. M—l was put artificially into a state in which he lost all memory of the experiences gained during the previous five years, including his knowledge of the English language. His memories were only those which he possessed five years previously, while he was living in his home in Russia. He therefore believed himself to be sixteen years old, and to be living in his native town. He understood and spoke only his native dialect, Russo-German.

This state in every way resembled one which B IV spontaneously entered on several occasions (Chapter XXVI, B IV b) when she thought she was living seven or eight years before in Providence, in fact was living in the hospital. Her memories were limited to that period. Now to show that in the case of M—l the memory of the English language was not lost, but only dissociated from the personal consciousness of the time being, and that it could be tapped and made to manifest itself, he was engaged in conversation in his native tongue by Dr. Sidis. While he was thus conversing, I stepped behind him and whispered in his ear in *English* that he should raise his right hand. At once his right hand was raised. Similarly he was asked in English where he was now living. In the midst of a German sentence, he interpolated the answer "Boston." Although his personal consciousness did not understand the words addressed in English, the dissociated conscious states responded.

Again Miss Beauchamp falls into a state of extreme disintegration (on one occasion as an after effect of etherization, and on another from causes not necessary to mention now). She does not recognize me or her surroundings, nor know her own name. She does not know the day of the

<sup>1</sup> Boston Medical and Surgical Journal, June 23, 1904.

week, and little or nothing about herself. She is in a delirious state, showing some temper when restrained, and keeps repeating a stereotyped phrase over and over again in a most tiresome way, "Let me go," "Let me go." Every question brings out only this response. I whisper in her ear that she is to answer my questions by raising her right hand for "yes" and her left hand for "no." She is then asked in a whisper the day of the week, the days being slowly recited to her. When the correct day, Thursday, is mentioned, the right hand is raised, while the left is raised when the other days are mentioned, this in the midst of the eternal repetition of her tiresome phrase. In this way she signals she does not want to go, recognizes my name and the place where she is, and gives much other information, showing the momentary presence of a dissociated sane consciousness coexisting with the poor dissociated one. In the same way she answers by speech. The delirious consciousness was unaware of the whispered questions and of the subconscious sane replies. The second consciousness, as was afterwards shown, was not Sally. Such observations show the character of this kind of amnesia, but in these experiments no attempts were made at synthesizing the disintegrated fragments of consciousness.

These phenomena confirm what Janet has so strongly insisted upon as the characteristic of hysterical amnesia; namely, that from one point of view it is not amnesia at all, that the lost memories are conserved, but so dissociated from the personal consciousness that they cannot be recalled. They can, however, be awakened as automatic phenomena.

The classical case of Mme. D. is a good illustration of extensive amnesia of this kind in an otherwise intelligent mind. It was studied by Charcot,<sup>1</sup> and later by Souques,<sup>2</sup> and Janet.<sup>3</sup> On August 28, 1891, the poor woman received

<sup>1</sup> *Revue de Médecine*, February, 1892.      <sup>2</sup> *Revue de Médecine*, May, 1892.

<sup>3</sup> *Mental State of Hystericals*, p. 90.

a terrible mental shock. She was working in her house when suddenly a strange man entered and roughly called out to her, "Your husband is dead. They are bringing him home. Prepare a bed, Madame D." The news was false, but the neighbors assembled and there was much emotional excitement. In the midst of it one of the women, seeing the husband approaching in the distance, was unfortunate enough to cry out, "There he is!" On hearing these words, Mme. D., believing that her husband was being brought home dead, fell into a hysterical attack, characterized by delirium and convulsions. This attack lasted three days. At the end of that time Madame D. came to herself, but then it was found that a curious thing had happened. She had forgotten everything that had occurred since July 14, six weeks previous to the shock, — a retrograde amnesia. But this was not all. She continued to forget everything that happened, everything she experienced, as fast as it occurred, hour by hour and minute by minute. (This is called continuous amnesia.) She lived her life as usual, but under the restrictions of this amnesia, which lasted nine months, until May, 1892. Among other experiences she was bitten by a mad dog, and was taken to Paris to the Pasteur Institute to be immunized. Her husband, taking advantage of her being in Paris, brought her to Charcot, at the Salpêtrière, November 23. She had no recollection whatever of anything that had taken place subsequent to July 14. For everything previous to that date her memory was good. She remembered nothing of the accident that caused her troubles, nothing of being bitten by the dog, of the journey to Paris, or of being treated at the Pasteur Institute. Later, after having been some time at the hospital, she could not remember, at any particular moment, where she was, or recall the names of those whom she daily met. Charcot was the sole exception. She had seen his portrait *before* July 14, and remembered his face. (Appendix E.)

Now it was easy to show that these lost memories were only dissociated, and not absolutely effaced. In the first place the patient was heard to talk in her sleep; that is, she dreamed about events which had occurred during the periods of the retrograde and anterograde amnesia. "That dirty dog," for instance, she said, "he has bitten me and torn my dress." In the second place, when hypnotized she recalled all the forgotten events and related them with exactness. She recounted the scene of August 28, the bite of the dog, her arrival in Paris, her inoculation against rabies, her visits in Paris, her entrance in the Salpêtrière, etc., with striking care and accuracy.

It thus was shown that in hypnosis the memories of past experiences were associated among themselves, systematized, and preserved, as if in the memory of a second personality. Janet, experimenting still further on the same subject, showed that the lost memories could be recovered in the waking state by the process of abstraction and automatic writing. The memorial images, therefore, were not obliterated but were merely dissociated from the waking personality. It required only a device to awaken the systematized memories, dissociated from the personal consciousness.

But the facts were something more than this. It was not alone that by an artifice Mme. D. was made to recall what she had forgotten. We do this in a different way every day of our lives. It is rather that at a time when the subject is unable to remember anything of a certain period, at this same time while in another state, she possesses completely the lost memories, and loses them again when she goes back to the waking state. With the alternating states there is an alternation of memory and amnesia, but during amnesia the memories almost seem to be waiting, as it were, to be recalled by the proper signal or device.

The case of Mr. Hanna, studied by Sidis and Goodhart,<sup>1</sup> also illustrates this principle. Mr. Hanna, it will be remembered, in consequence of a slight accident, suddenly, like Mary Reynolds, lost all recollection of his previous life. When he came to himself he could remember nothing that he had learned. He could not understand or speak the English language. The names of objects, and even their uses, were unknown to him. He did not know the meaning of an apple, or a pencil, or anything else. Even spatial relations were not recognized. The objective world seemed flat, and without perspective. In short, as far as his memory went, his mind was that of an infant; but it was that of an adult in its capacity to think, to reason, and to form judgments. It became necessary to begin his education over again, as with a child, teaching him to speak, to understand, to write, and to recognize objects and their uses.

By the process of abstraction — for which Sidis coins the word *hypnoidization* — vivid memory-pictures were awakened. Hanna was made to close his eyes, to “listen with all possible effort and attention to the reading of the Hebrew” scriptures, or anything else. While his attention is thus distracted “events, names of persons, of places, sentences, phrases, whole paragraphs of books totally lapsed from memory, and in languages the very words of which sounded bizarre to his ears and the meaning of which was to him inscrutable — all that flashed lightning-like on the patient’s mind. So successful was this method, that on one occasion the patient was frightened by the flood of memories that rose suddenly from the obscure subconscious regions, deluged his mind, and were expressed aloud, only to be forgotten the next moment. To the

<sup>1</sup> Multiple Personality (D. Appleton & Co., 1905); p. 95 *et seq.* See also “The Psychology of Suggestion,” by Boris Sidis, 1898.

patient himself it appeared as if another being took possession of his tongue.”<sup>1</sup> As with B IV, sometimes these memories, instead of being complex pictures, were scrappy, — mere flashes in the pan.<sup>2</sup>

The “mind-fixing” remembrances of B IV have their counterpart in these and similar observations. The condition of abstraction into which B IV put herself was one of semi-hypnosis, — one in which experimentation, in her case as well as in Mr. Hanna’s, has shown it is easy for sensory automatisms, that is, visual and auditory representations, or memorial pictures of past experiences, to arise. These memory-pictures were the same in principle as those which flashed into B IV’s consciousness when she “fixed her mind,” and the method was the same. There was this difference: with Hanna these revived experiences were never recognized as in any way familiar; in B IV’s case the synthesis of memory with the personal consciousness was more complete, for the visualized and other memories were recognized as her own experiences and remembered as her own.

In the case of B IV the spontaneous “scrappy” memories were of the same nature, though they did not occur in states of abstraction, but more closely resembled ordinary but partial memory. They were the incomplete synthesizing of the dissociated memories belonging to state B I. The difficulty in determining all this was due to the persistent concealment of the facts by B IV.

Associated with this class of memory flashes there was often experienced another phenomenon which was liable to be the cause of embarrassment. The recognition of this phenomenon is of practical importance as it is not rarely observed in the neurasthenic psychoses. It was the sudden

<sup>1</sup> *The Psychology of Suggestion*, Boris Sidis; p. 224.

<sup>2</sup> *Multiple Personality*, p. 143.

awakening of an apparently paradoxical emotion in connection with a strange person or place, or in consequence of a reference by some one to an apparently unknown event. Or, the emotion might arise in connection with a memory flash, but in neither case was there to B IV any accountable reason for the emotion. It can be imagined that the experiences were disagreeable enough. To find yourself suddenly, without rhyme or reason, feeling an intense emotion in connection with something or other which you scarcely remember to have seen or heard of before is annoying, at least.

The explanation was not difficult. These experiences were plainly emotional automatisms, and, as such, association phenomena connected with experiences in the life of B I. They belonged to a class of phenomena which I have termed association neuroses.<sup>1</sup> They differed essentially from the subconscious fears described in Chapter VIII. Those emotions belonged to ideas which were subconscious, and invaded the waking consciousness without the memories to which they were attached. But B I's mental life was not subconscious in respect to B IV. It was dissociated, forgotten, but not subconscious. These paradoxical emotions were not, then, excited by subconscious memories, but by perceptions (of persons, places, etc.) which were in the primary consciousness. The memories associated with these perceptions belonged entirely nevertheless to B I's consciousness and therefore were forgotten; nevertheless the visual, auditory, and other images of a person or a place, or whatever it might be, aroused in B IV, in spite of her amnesia, the emotions which had been previously associated by B I with these images. The visual image of anything with which any emotion had been associated in B I re-

<sup>1</sup> "Association Neuroses," *Journ. of Nervous and Mental Diseases*, May, 1891. "Three Cases of Association Neuroses," John E. Donley, M. D. *Boston Med. and Surg. Journ.*, Nov. 3, 1904.



excited in B IV that emotion, although the associated experience had belonged to B I.

The same thing in principle one frequently observes as a neurosis in so-called neurasthenics. Mrs. W., for instance, while passing a certain house, suddenly experienced an emotional symptom-complex (palpitation, feeling of suffocation, general exhaustion, etc.). She had not noticed the neighborhood and did not consciously recognize the house, which resembles in design the neighboring houses in the same block. Startled by her symptoms, she looked up, half in search of a cause, and then for the first time recognized the house she had just passed as a private hospital where three years before she had had a very harrowing experience connected with her child's illness. Associations of the hospital are so unpleasantly strong that she cannot bring herself even to engage a nurse connected with it. This experience is similar to numerous others of the same kind which Mrs. W. has had and in which the same symptoms have been excited by association of ideas. The explanation of this particular experience which first suggests itself is that Mrs. W. subconsciously recognized the hospital as she was passing, and that the subconscious unpleasant memories aroused the symptoms. But a careful examination in hypnosis failed to show any subconscious recognition or any perceptions different from those of the waking consciousness. We are forced to conclude that the peripheral visual images of the house alone by pure association aroused the emotional symptom complex, as an automatism.

Aside from the interest of unravelling the mysteries of a particular case, the psychological importance of these isolated memory-pictures lies in the light they throw upon the problem of multiple personalities. They indicate the purely dissociative character of the amnesia. In the particular case of Miss Beauchamp, we know that when B IV was present, the memories of B I were not effaced, for B

I alternated with B IV, and on the former's reappearance the memories of that personality's life were regained, and B IV's experiences in turn dissociated.

But suppose, as I have said above, the case had not come under observation until after the appearance of B IV on the night of June 7, and that she had not again reverted to Miss Beauchamp (B I). It might then have been hastily concluded that B IV's amnesia for the preceding six years showed that the memory for this period had been absolutely effaced.<sup>1</sup> The phenomena we have been describing would have shown that such was not the case, but that they were only dissociated from a particular personal consciousness, and for some unknown reason a complete synthesis could not be made.

In thus explaining these memory phenomena Sally has been left out of account. There never has been any evidence that Sally's memories were the source of B IV's "mind-fixing" or "scrappy" memories. If this had been the case, it is inconceivable that the regained memories should not have included some of Sally's own experiences as well as those of B I. This was never the case. B IV never recalled any facts by these processes other than those of B I's life, never one of Sally's. This is a curious and interesting fact. The process of abstraction failed to revive any memories pertaining to Sally's existence. With true visions it was different. By this method she occasionally got at Sally's experiences. For instance, she once saw herself (in a vision) as Sally driving in a carriage with a friend. The reason for this difference is not entirely clear, but the facts corresponded with certain results obtained by myself experimentally.

The "mind-fixing" phenomena were largely the result of memorizing processes. The pictures which she called

<sup>1</sup> Assuming also there was no third personality (Sally), as is often the case.

up were vivid, to be sure, as in visions,—more vivid than occurs in ordinary memory, but the visualized experiences were remembered as experiences of her own. On the other hand, the visions were pure automatisms, excrescences in her mind, without conscious association with the other experiences of the life which they pictured. When seeing a vision she did not recognize the pictorial experiences as her own, even though it was of B I's life; there was no sense of memory connected with it.

Now it was found experimentally easy to amalgamate by suggestion the dissociated experiences of B I with those of B IV so that they were remembered, but impossible to amalgamate Sally's with either. These latter could experimentally only be awakened as sensory automatisms (for example, vision of Sally smoking cigarettes). Corresponding therefore to these results, B IV could by "mind fixing" synthesize with herself some of B I's experiences, but the same method failed to do this with those of Sally. She could get from Sally's life only a vision, which still remained without conscious relation to any part of her life.<sup>1</sup>

<sup>1</sup> For an interesting theory of hallucinations, see "An Inquiry into the Nature of Hallucinations," by Boris Sidis, *Psychological Review*, Vol. XI. No. I, January, 1904.

## CHAPTER XVI

### AN IMPORTANT DISCOVERY: B I AND B IV WHEN HYPNOTIZED BECAME THE SAME PERSON

*November, 1899*

VERY little has been said since Sally's arrival about B II, and little more than a reference has been made to the fact that the Idiot could be hypnotized, and that this was habitually done for therapeutic purposes. As to B II, the fact is, little had been seen of her since Sally's advent. Sally, whether with premeditation or not, almost always came in her place when B I was hypnotized, and being the most interesting personality, and the one who had to be reckoned with, I got into the way of calling for this young woman. Still, a state of hypnosis which was supposed to be the original B II was occasionally obtained. It was never encouraged to develop any spontaneity, but was made to remain with the eyes closed, answering questions, and receiving therapeutic suggestions. Under the circumstances there was no reason to suspect that it was not the original B II.

When B IV was hypnotized she went into deep hypnosis. A very extraordinary change came over her. When, in the original observation, B I was changed to B II the latter retained all the fundamental characteristics of B I. When B IV was hypnotized her character became completely metamorphosed: no longer hostile and reticent, but friendly and frank, she ceased to prevaricate, and made no effort to conceal her thoughts or the facts of her life. She answered questions freely and openly, frankly confessing her ignorance as B IV and the falseness of her pretences.

She stated, for instance, that what she had said a moment before as B IV was not true, and that as B IV she had no knowledge whatever of what had occurred in the room when B I and Sally were present. She was docile and obedient, accepting suggestions without remonstrance. For purposes of convenience this state was labelled B VI.<sup>1</sup> On waking B IV had complete amnesia for this state. Of course the same was true of B I.

Beyond this, B VI had not been particularly studied at this time, being looked upon as a simple hypnotic state. A discovery was soon to be made which was not only psychologically instructive, but was to give an entirely new aspect to the problem.

On November 5, 1899, B VI was present for awhile; then, changing to Sally, the latter was hypnotized and transformed in turn to B I. B I was now put into hypnosis, and became B II,—the original B II, as was supposed.

I was in the act of giving B II some suggestions about sleeping, when suddenly Sally bounced out and exclaimed excitedly, "Oh, Dr. Prince, I came to tell you that I think the Idiot hypnotized is the same person as B I hypnotized, *for I know the Idiot's thoughts when she is asleep just as I do B I's then.* I may be wrong, but I think so."

We talked it over, and I pointed out to Sally that if her discovery should turn out to be true, then the memory of B II must be the same as that of B VI, and *vice versa*. As B II knew all about B I, and B VI knew all about B IV, then this combined hypnotic self must know all about both B I and B IV. It was agreed that observations should be made to test the theory, and then Sally "folded herself up," and disappeared to watch the game. Sally's discovery was most exciting. Even Sally, the hater of psychology, caught the contagion of the chase for the moment. If it was true we might at last have a

<sup>1</sup> B V was Sally hypnotized.

clue to the solution of the mystery; a solution, that is, which would explain the relationship of the different personalities and disclose the real self. B VI would be more than simply B IV in hypnosis. Her memory would be as complete as that of both the other personalities, B I and B IV, put together, *a synthesis of the two*; and as her character manifestly differed (for the better, thank Heaven!) from that of B IV, *she might be another personality (in hypnosis), perhaps the real one we had been seeking*. In this personality, too, all the experiences of the two others would be already organized. It was plain, if the discovery should be verified, that an alternative theory offered itself in place of the one that made B IV the real self.

The import of the discovery occurred entirely *independently* to Sally, for the next day she wrote the following letter setting forth the new theory as her own. Though psychologically crude, it expresses quite clearly some of the facts we expected to prove. It will be noticed that, rightly or wrongly, Sally wobbles, abandoning her previous theory that B IV is the real self, and harks back to her old insistence that the "Idiot" is not a real person.

“ ‘*T is the voice of the lobster.*’

[Nov. 6, 1899.]

“ Start with Miss B. and the ‘Idiot,’ and call them number *one* and number *two*. Hypnotized *each* becomes number *three*,<sup>1</sup> and this number *three* remembers everything concerning both *one* and *two*. Then can’t one call number *three* the real, complete Miss B.? But one is n’t sure whether this number *three* on being awakened will become number *one* or *two*. Putting it that way is confusing. It is simpler if you say that one can’t be sure whether number *three* on being awakened will or will not remember all that has happened since that shock in ‘Providence.’ If she does remember, she becomes number *one*, if she does n’t then she’s number *two*. But I still think there is n’t a number *two*

<sup>1</sup> Called II in this account.

[Idiot] properly speaking — not a real person — distinct from number *one*. For number *two* only appears when certain old memories are recalled. She is like number *one* in a rattled and irresponsible condition, does remember number *one's* life in some way *other* than by getting it through visions, remembers it *at least* as well as she does her own. Also number *one* knows much of number *two*, which is one reason she thinks she loses so much less time than she really does. How does she know it? How does number *two* get her scrappy information unless from *three* where they (*one* and *two*, that is) become *three*? I dare say my reasoning seems very absurd to you. It does to me rather, for I don't seem to have expressed it clearly as it is in my mind. I am too squeezed — worse than ever before in my short existence. Amen. S. B. 49."

Sally's language implies that Miss Beauchamp and the Idiot had more knowledge of each other than they really had; more than Sally intended to suggest, for she did not know the Idiot's thoughts. This knowledge was, as we have seen, and as Sally says, only "scrappy," welling up into consciousness from apparently nowhere. This was further demonstrated by the fact that this knowledge on the part of one of the personalities did not follow immediately the events of the other's life, but came only after long intervals, rising as out of a mist. At most, it was indeed "scrappy," with great blanks when the cleavage of memory was complete; as, for example, when Miss Beauchamp was "gone" for the month of August she lost this amount of time completely out of her life, without a vestige of memory of it at the time of her return. Another instance is contained in Miss Beauchamp's letter of September 24, in which she says:

"There is little I can tell you, for I have lost most of the time since the evening of the twelfth [12 days], only coming to myself for a few hours on Friday last, and again this afternoon."

Sally more correctly expressed the facts of memory the next day in a second statement of the theory, which may be epitomized as follows, the nomenclature being that used in this account:

Let X = the real original Miss Beauchamp. Then X is B II or B VI, who are one and the same.

X wakes and becomes B I or B IV, but B III cannot tell which will come to the front.

Both B I and B IV can get at *some* of the experiences of each other, but B III does not know to what extent each can do this.

B I tends to get rattled and pass into B IV when incidents occur which tend to make her mind dwell on a certain "cause of perturbation."

My theory that B II (B VI) might be the Real Miss Beauchamp was subject to one difficulty. By the theory, if we hypnotize B I and B IV they become synthesized to the real self in hypnosis. If this self be waked up it ought to remain X; yet, in fact, on waking B II becomes, not X, but dissociated into either B I or B IV again. Why should not B II, if she is the real self, remain synthesized and become X on being awakened? As we shall see, this has great significance.

As has been said, Sally's discovery of the identity of B II and B VI, if verified, was of the utmost value. It might prove to be the long sought for key to the riddle; or, at any rate, it would make intelligible several apparently paradoxical phenomena, and might lead to the discovery of the real self. All previous hypotheses were in doubt. Not only B I but B IV might have to go, to give way to a stranger whom we had never seen, but who in hypnotic sleep might be B II (B VI). What sort of a person would this prove to be?

The next day, November 8, an opportunity was offered to test the theory of the identity of B VI and B II.



B IV was hypnotized and changed to the hypnotic self, B VI. Was this self identical with B II? That was the point to be tested. She was questioned on the conversation between myself and B IV five minutes earlier, and about B IV's movements in the room. She knew all this, and repeated the conversation word for word.

The next test was for her knowledge of B I. The following was selected: Miss Beauchamp had been much distressed about some letters in her own handwriting which she had seen at a previous interview, lying on my table. She had assumed that they were written by Sally, who, she believed, had probably said a lot of "mad things," and she wanted the letters back. Worrying over this had caused her sleepless nights. B IV had had no opportunity to see these letters. There were three of them, — either in envelopes or folded so that they could not be read: one from B I herself, one from B IV, and one from Sally.

The *hypnotized* B IV was asked to repeat the substance of these letters. She repeated accurately the contents of that from B I as well as that from B IV, but she had not the slightest knowledge of the contents of Sally's. She further remembered, *as B I*, seeing Sally's letter on the table, and described its appearance; it was easily distinguished from the other two by being written on foolscap. It must be kept in mind — though it is hardly necessary to give the details here of the demonstration — that B I awake did not know B IV's letter, nor did B IV awake know B I's letter.

Testing further the hypnotic self of *B IV* for knowledge of B I, it was found that she knew all that part of the hospital episode of 1893 for which the memory of B IV awake was blank, but which B I knew; that is, what occurred after she left the ward. She described with accuracy everything that had taken place, just as B I and Sally had described it. This self also described accurately

the visions which B IV had had. In the same way a large number of events in the lives of B I and B IV were gone over and it was found that she remembered accurately the lives of both. Likewise, when B I was put into hypnosis the resulting hypnotic self, B II, knew all about her life as B IV as well as her life as B I.

The memories of B II were the same as those of B VI.

So, then, Sally was right in saying that so far as *memory* went B VI and B II were the same person; or, putting it in other words, that B I and B IV when hypnotized became the same person. All future experiences confirmed this result. The hypnotic self always had a complete knowledge of both personalities, — of their actions and thoughts.

It remained to compare the *characters* of B II and B VI as distinguished from their memories. Perhaps it may be as well to anticipate here by saying that in everything that goes to make up character — habits of thought, temperament, aspirations, wishes, tastes, mode of reaction to environment — they were one and the same personality. Consequently from this time on, this hypnotic self was always designated as B II, and there was no longer a B VI.

So B II had now become a very important factor in the problem. In contrast with B II's complete knowledge of Miss Beauchamp and the Idiot, was the complete ignorance which she exhibited of Sally. Never, on any occasion, at any time since she has been under observation, has B II had the faintest glimpse into her life as Sally. Sally's life is a sealed book to her.

Pursuing now the method which had already been practised with gratifying results — that of interrogating each self in regard to its own psychical life and its relations to the other selves — some interesting and corroborative information was obtained from B II. She considered, she

said, the personalities called B I and B IV the same as herself, only that when awake as B IV she (B II) becomes "confused," and then says all sorts of "mad things" and fibs. Why she fibs she does not know, but she is not herself then and cannot help it. She does not consider that she (B II) "loses time" when confused: when she "loses time" it is different. (By this she refers to the periods of Sally's existence.) For instance, to-day she "lost time" only from half-past twelve to half-past one, and from half-past two to six o'clock, for she has no knowledge of these hours. (From 2.30 to 6 o'clock Sally was with me.) She does not consider it "losing time" during the other periods when she is B I or B IV. The logical attitude of B II in this analysis of herself is self-evident. As she knew everything she did and thought as B I and as B IV, there could be no oblivion for her during those periods, and she could only regard herself as changing in character. Neither did she speak of B I or B IV as different persons, as Sally does. She did not call either "She," but used the words "myself" and "I" for each personality, as well as for herself as she was at the moment asleep: "I became confused." "I don't know why I fib." Similarly, at later interviews, when to test the personality I used to ask who she was, she would reply, "I am myself."

"Where is B I?"

"I am B I."

"Where is B IV?"

"I am B IV."

On this occasion, in reply to questions, she went on to say that she (meaning B I) had changed in character since the hospital time; but she found difficulty in describing how, except that she had grown morbid and nervous and was not herself (Miss Beauchamp). She appealed for help, as she did many a time afterward, begging me pathetically to wake her up and make her herself, — make her so that

she would remember everything and not have gaps in her memory; not prevaricate and not tell fibs (B IV). Most piteously she pleaded that this should be done; that she should be made herself. She seemed to mind Sally's coming most, for she knew nothing of what was done at such times. From the after evidences, from the letters to herself and others, from the devilish humiliations she was forced to undergo, the hundred and one torments she endured, she knew that she had been acting a part, and living a life that belied her character and was mortifying to her pride. Her conduct as B IV, when, as it seemed to her, she was not herself, almost equally troubled her.

The personal testimony of B II, then, clearly corroborated that derived from experimental tests and other observations, and showed that B II and B VI were the same person. This interview terminated with a scene which was full of dramatic effect:

The discovery pointed to a way to synthesize all the memories of Miss Beauchamp and B IV, and to combine them in one person, which after all was one of the main objects sought. If B II could be waked and be made to retain in the waking state everything that she knew of B I and IV, the resulting personality, whether B I, B IV, or the real self, would at least be a great improvement over anything we had had. If B IV was not the real self there was no object in keeping her. According to the new hypothesis B II, hitherto like Cinderella neglected and passed by, might be the very self for whom we had been hunting. Before it could be determined further experiments had to be undertaken, but for the present it seemed worth while seeing what would happen if B II was awakened, her eyes opened, and made by suggestion to retain her present memories. A preliminary suggestion was given as follows:

"When you awake, you will know everything. You

will be yourself as you were before 'Providence.' You will remember everything."

While saying this I was startled to hear the words, uttered in a deep, angry tone, "She sha'n't know my thoughts." Her face had been that of complete placidity. For a second the features became ruffled with anger, and then subsided again into their former calm. After the first surprise, I recognized Sally's interference. B II of course did not hear her own voice. I scolded Sally severely, — talking to her through B II, — knowing that she would hear. But II, being all unconscious of what had happened, did not understand my real intention. My manner was severe, and to B II it seemed that I was upbraiding her who had just been pleading for life. She asked why I spoke in such a way. What had she done? She seemed to feel it keenly. "Don't pay any attention to what I say," I replied; "I am speaking, not to you, but to Sally, who hears." "Sally? Oh, yès," she answered; "she writes me letters —" her sentence remained unfinished, and she became dumb. She could not speak a word, her lips were sealed and her tongue tied. Again I scolded Sally for interfering. The scolding had its effect. B II was proceeding once more to appeal for help, when she exclaimed: "Oh, Dr. Prince, I can't think any more! I feel just as if something had taken hold of my brain and stopped my thinking. It is just as when that thing makes me see and do things I don't want to see and do, — as if a part of my brain were held."

Again I scolded Sally, who yielded at last, and B II went on with what she was saying. She was then simply waked, without more ado, and the resulting personality was only B IV.

It remained to determine what relation B II bore to the real self, which self might be X, or when in hypnosis B II herself. This question was postponed for future study.

It was not long before B IV began to relapse again into her earlier condition of antagonism and independence. The open-minded mood of November 1 and 3 soon came to an end, and, as her character gradually unfolded itself, it became evident that, however strong a personality she might be, the idea that she was the real and original Miss Beauchamp was, as Sally said, "rubbish."

The following from B IV, written immediately after the interview of November 1 (Chapter XIV), when her trouble was explained to her, speaks for itself:

[From B IV, Nov. 3, 1899.] "I have been thinking over what you said this evening, and while I appreciate your kindness, I believe it better not to trouble you with my woes, so long as they are only such as any one can help me out of. I have never known until to-day just what was wrong and, not daring to ask, have fancied that perhaps something dreadful — something horrible — had happened which people were keeping from me intentionally; but if it is only something growing out of that summer in —, a sort of dream life, why, it simplifies things wonderfully, for Mr. J—— will, I am sure, tell me everything that has happened since — all about the things done and those left undone — and that will save your time too, which I am afraid you have been giving me freely. And I shall take up nursing again now — the old life which I love so much — better than any other in the world, — as you probably know. I can hardly wait to see about it — I am so excited.

"You have been awfully good, I am sure, and I hope you will believe me both grateful and appreciative. I know how infinitely trying I am as a patient, and am afraid it has been hard for you sometimes. Mrs. X—— did not know all my 'outs' or she would hardly have taxed you so. I shall try if possible to see you before I go and thank you. You have lifted such a weight from my mind.

"P. S. I am going to enclose a note in this which I have just received, and beg that you will tell me who the writer is. I cannot get her myself, — have no other letters from her, and yet she evidently knows me very well indeed. Unless you

can enlighten me, I am afraid we shall not 'talk ourselves to death.'"

As we went on to study B IV we found that her habits of thought and her conduct were as different from those of the original Miss Beauchamp as chalk is from cheese, however plausible she at times made herself appear. One unfortunate trait which she exhibited was that of falling into uncontrollable fits of anger if thwarted. This led frequently to the destruction of documents which, as I view it, were an irreparable loss.

Sally had agreed to write the autobiography of her own (subconscious) life, and for this purpose used to come to my office during the mornings. It was impossible to take B IV into my confidence, because if there was one thing more than another to which she objected it was revealing her private affairs, no matter how trivial. She simply refused to allow it. Then again, much that Sally wrote was unknown to B IV, and therefore the latter would and did deny its truth. So Sally used to come mornings and write. One day B IV was found with a number of crumpled sheets of Sally's manuscript in her hand. She was moody, angry, uncompromising. It happened that while writing Sally had had the ill luck to change accidentally to B IV, who thereupon read the autobiography. The cat was out of the bag. The danger of the destruction of the manuscript was imminent. Diplomacy proved useless, and the papers were carried away. There was a faint chance that Sally would somehow prevent the threatened destruction, but B IV came out on top and the work was destroyed. The following letter came the next day:

[From B IV.] "My coming here mornings — however amusing it may be — is utterly out of the question. You have made it awfully hard for me in losing this whole week. I cannot afford such things, believe me.

"P. S. I don't know what papers you wished me to leave for you. Those I had in my hand were only some scribbled sheets of my own — nothing concerning you in the least."

The "sheets" were Sally's autobiography. It was not far advanced and the loss could be easily retrieved, but shortly afterward IV succeeded in inflicting a greater damage. Sally had begun again, and the autobiography, after weeks of labor, was well under way, — perhaps half done. Entering the room one day, I found B IV with a pile of torn pieces of paper in her lap, each piece about the size of a postage stamp, and enough pieces to fill a half-gallon bowl. It was the precious manuscript. Let me tell why it was regarded as of such importance.

Shortly before this, on October 26 (1899), Sally had entered at great length into the question of her own independent existence, apart from that of B IV and B I. She insisted that she had always existed as a real and separate person from early childhood. By this she did not mean, of course, that at this period there were times when she was the sole or an alternating consciousness, when she walked about and led a life independent of the primary consciousness, as she does at present; but that within, or alongside of, Miss Beauchamp's consciousness there has always existed a conscious nucleus which thought and felt independently of the primary consciousness, and which had its own memories of which Miss Beauchamp knew nothing.

In evidence of this she recalled successive events in her own psychological life at different ages. She described her own thoughts at such times and contrasted them with what B I thought at the same moment. She claimed to remember what she, as distinct from Miss Beauchamp, thought at the time when she was learning to walk. Then B I was frightened, she said, and wanted to go back, but subconscious Sally was not at all frightened and wanted to



go ahead. She described B I as having had a butterfly mind as contrasted with her own. She, as a small child, disliked the things that B I liked, and *vice versa*. She described her school life, her own feelings when B I did things, and the different sensations of the two selves when, for example, B I was punished and felt badly, while she herself was entirely indifferent and without remorse.

Then, coming to a later period, she instanced the occasion (brought out in a crystal vision), when she saw J., who was standing behind her, crush a watch which he held in his hand, although this was not observed by Miss Beauchamp.

"I often saw things that she never saw. I saw J—— crush the watch when she did n't."

"Did you hear it?"

"I saw it, and heard it, too."

"How could you see it? You said he was behind you."

"He was not exactly behind, but behind my shoulder. I may have seen it out of the corner of my eye, just as I see this table now out of the corner of my eye, though I am looking at you."

"Why did n't she see it?"

"I don't know." Then, meditatively, "Why can't I see crystal visions? I can't. When she sees things and does n't remember them, I often can. She forgets, but I don't. I suppose this is because her mind is busy with one kind of thing, and my mind is busy with another kind."

And so Sally went on, recalling many instances of double consciousness during her girlhood, but it was not until she got her eyes open that she had an independent existence. Before this, as she maintained, she could think separately, but could not act as an independent consciousness excepting on rare occasions when she could make "her" do things. With the exception of these occasional instances she had had very little power over

"her" body until she "got her eyes open." (I have often seen Sally, co-consciously, smile through Miss Beauchamp's tears, so to speak, producing a most curious effect.) Sally harps upon the fact that getting her own eyes open made herself "alive," and gave an independent existence in the sense of having sole and complete use of the body. In explanation of these statements she agreed to write an autobiography of herself, of her own consciousness as distinct from Miss Beauchamp's, beginning with the earliest years.

We need not enter here into the credibility of Sally's statements, for, whether credible or not, from this general résumé, it will be seen how important it was that Sally should herself write a continuous account of her own mental life, contrasting it with the mental life of Miss Beauchamp, as Sally saw both. The reliability and value of such an account could be determined later. The first thing, whatever its value, was to get it. It was this precious manuscript which B IV had destroyed.

This vandalism, the fits of temper, the relapses from the periods of rationalism, the lack of self-control, the suggestibility, all indicated abnormality and strengthened the belief that B IV was not, after all, the true Miss Beauchamp. Indeed, everything warned us that we must still be on the hunt for the real self. We had got as far as identifying B II and B VI. Was B II the real self, after all? If not, who or what was the real self? If B II were this self there followed consequences of importance, for then neither B I nor B IV was real, but each was a sort of somnambulist. If B II were the original Miss Beauchamp, then it probably would be found that if the suggestion were given that, on waking, she should remain *herself* and not change to B I or B IV,<sup>1</sup> and then were

<sup>1</sup> B II had been told many times to open her eyes and awake — this was the customary way of awaking her — but always on awaking she changed to

simply told to open her eyes, she would awake with all her faculties, complete and whole, — the original Miss Beauchamp as she was before being overwhelmed by the various psychical accidents that had befallen her. This experiment had been tried, tentatively, on November 8, but was balked by Sally.<sup>1</sup> It did not seem wise to rashly persist until it was positively determined that B II was the real self; for if B II should get her eyes open and obtain an independent existence, and then prove after all not to be the right person, there would be a pretty “howdy-do.” We should have four personalities instead of three to take care of, and we had our hands quite full enough already. It remained then to study B II as well as B IV.

After all Sally’s theorizing the following came as an anti-climax:

[Letter of Nov. 27, 1899, from Sally.] “Don’t reckon positively on my coming Tuesday morning, and don’t — please don’t — lay too much stress on my theories. *I hate psychology.*”

“P. S. I don’t want to be a ‘subliminal.’ . . .”

The relations of B I, B IV, and B II with one another, as thus far made out, could be diagrammatically expressed in the form of a genealogical tree as follows:

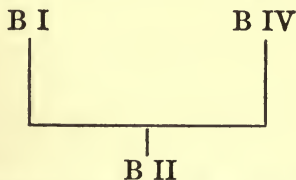

The solid line indicates both descent and synthesis.

Where was the original B?

B I or B IV. It was therefore necessary by suggestion to prevent her from changing her personality, which by the hypothesis was the real self as it existed before “Providence.”

<sup>1</sup> Page 275.

Attention has already been called to one more point, which needs to be kept in mind, that when B I and B IV became B II a very wide synthesis took place. B II had the memories of both I and IV. She was more, then, than a mere hypnotic state of either. She was a synthesis of both, though in hypnosis.

## CHAPTER XVII

### STUDIES IN CHARACTER

IT will be remembered that it was determined in the course of the study of B I that that personality was subject to grave instability and suggestibility. It remained to make a similar study of B IV. Besides amnesia (Chapter XV) such a study necessarily included:

(A) Phenomena of dissociation and automatism.

(B) Health.

(C) Physiological, moral, and mental reactions, particularly as contrasted with those of B I.

(A) *Dissociation and automatism.* A high degree of suggestibility is a departure from the normal, and belongs among the stigmata of hysteria. The crystal vision of the hospital adventure, and of her "coming," June 7, as well as those visions which she induced in herself, were indicative of suggestibility of no mean degree. The automatism was further evidenced by the *spontaneous* outburst of subconscious activity; for instance, Sally's inhibiting or perverting the thought of the personal self. Systematized anesthesia and positive hallucinations could also be induced in her from within, that is to say, by the influence of a subconscious idea, — the subconscious idea being Sally's. Such phenomena must be regarded as evidence of a mind that has undergone some degree of disintegration. I emphasize the word "spontaneous," because, by artificial means (hypnotic suggestion) a mental dissociation in some apparently *healthy* people can be experimentally induced which is capable of exhibiting such automatic phenomena

(post-hypnotic suggestion, etc.). We shall later see that, to the degree to which B I and B IV were restored to the normal, Sally lost the power of influencing the resulting personality.

Numerous observations might be given of the spontaneous action of the dissociated extra-consciousness (Sally) on the personal consciousness (B IV). A sufficient number of examples will be found in the Appendix. The resulting phenomena consisted of hallucinations, paralysis, aboulia, amnesia, automatic speech and writing, etc. Thus Sally on one occasion by an act of volition altered the details of a "mind-fixing" vision through which B IV endeavored to obtain information of the circumstances of her stay as B I in a private hospital. B IV, in consequence, saw in the room Dr. S. whom she did not know, etc. (Appendix F.)

On another occasion, subconscious Sally, paralyzing B IV's tongue and lips, made her dumb. B IV, however, was in a hypnotic state at the time, and therefore the observation must be taken only as illustrating the ease with which a disintegrated mind can be influenced, whether from within or from without, to exhibit abnormal phenomena. When the primary waking consciousness exhibits such phenomena it is presumptive evidence of abnormality. (Appendix G.)

On another occasion Sally produced motor automatism and systematized anesthesia (negative hallucinations) in B IV. In this observation B IV seized a pencil out of my hand and threw it across the room, and then was stricken with blindness for written messages intended for Sally. (Appendix H.)

On another occasion B IV became blind for the text of a French book which appeared to her to be a blank notebook. Then, when directed to pick out a French book from the bookcase, she saw no bookcase at all, but insisted that the

walls were sheathed with wooden panels like the rest of the room (positive hallucination). The dominant idea and belief that there was no bookcase in front of her induced the positive hallucination of wooden panelling. B IV owed this hallucination to Sally's jealousy of B IV's accomplishment of reading French. (Appendix I.)

On another occasion I saw an exhibition of the *contest between two wills*—between that of the personal and that of the dissociated consciousness. Sally tried to make B IV dumb; B IV, bound that she would talk and not be controlled, succeeded by dint of much stuttering, in making herself understood. (Appendix J.)

Again B IV was afflicted with amnesia for the name of a person of whom Sally is jealous. Sally would not allow that name to be mentioned.

Automatic writing and speech were very common. Numerous records of the former will be found in Chapters XXII and XXIII, and instances of the latter are interspersed throughout this account.

Phenomena of the kind just recorded are indicative of more than suggestibility; namely, of the dissociation of consciousness, and the coactivity of the dissociated mental states (Sally). It may be pointed out in passing that some of the hallucinatory phenomena in this case illustrate the relation between such phenomena and the dominating ideas (beliefs, etc.) which directly give rise to them; for instance, the illusion on the part of B IV of mistaking me for some one else, on her advent, June 7, 1899. *The illusion was the psychological expression of her belief.* Believing the time was 1893, the scene the room in the hospital, and that she had just seen Jones at the window, the illusion was suggested by this belief. So, also, when B I failed to see the rings upon the ribbon tied to her neck, this negative hallucination was the expression of the belief that she had lost the rings. Again, when B IV believed for

the moment that there was no bookcase in front of her, the hallucination of the panelling was the expression of this belief.

Similarly, another patient, Mrs. J——n, previously referred to, who, like B IV, on "waking up" went back nine years in her life, and who at the time of her "disappearance" was slight of figure but in the interim had grown fat, with a girth of waist of thirty-four inches, insisted, by an illusion, on reading the tape measure twenty-one inches, that having been her measurement at the earlier period. She could only see herself, too, as slight in figure.

Such phenomena answer the famous question of Griesinger, "Why do insane people believe in their hallucinations?" The answer in many cases, though not in all, must be, They have their hallucinations because they believe the content of them to be true. The hallucination is the expression of their belief.

In other cases, however, the hallucination, as well as the systematized anesthesia, is not dependent on the belief in the primary mind, but is plainly the action of subconscious mental states upon the waking consciousness. When B I failed to see the rings, the primary belief originated entirely in her personal mind; but when B IV failed to be conscious of the bookcase and of the writing on the sheets of paper placed before her, the systematized blindness was induced in some way, — unnecessary for us to inquire into in this place, — by the action of a subconscious, dissociated mind (Sally) upon the personal mind, robbing it of some of its visual perceptions. Psychologically, a negative hallucination, the failure to see or hear something present, is very different from a positive hallucination, yet both may have their origin in the action of extra-conscious ideas upon the personal consciousness. Examples of positive hallucination arising in that way will occur all through this biography. It would seem that observations of this



kind, and they are manifold in variety and number, open up to the alienist a field for experimental inquiry which should produce a rich harvest.

These observations, as well as numerous others of automatic writing, showed first, abnormal suggestibility on the part of B IV; and second, that Sally, as a group of autonomous dissociated states, coexisted with B IV.

(B) *Health.* The matter of health was of some importance in deciding upon B IV's identity even, as it offered an interesting study of neurasthenia and the influence of the mind on the body. If she were free from neurasthenic symptoms it would be another point in favor of her normality and identification with the true self. B IV did not require, indeed refused, medical advice. She claimed to be strong and free from symptoms. Was this true, or was it only a bluff, to escape supervision? It took some time to determine this point, and it was not settled until one day when, unable to stick it out, she broke down and asked for medical help. It then transpired, and was afterward frequently confirmed, that she was more or less of a neurasthenic; but still the interesting fact was brought out by degrees that there was a vast difference between the physical health of B I and that of B IV. B IV was much the stronger of the two, so much so that she herself scarcely recognized any unusual limitation to her powers, and, if she had not been the victim of constant harassing troubles, she would have had fair health. The dependence of *physical infirmities*, like pain, fatigue, and insomnia, upon a mental change of personality is a matter of considerable significance from the point of view of the pathology of the neurasthenic state. This was particularly illustrated by Sally, who was absolutely free from ill health. She did not know the meaning of pain and fatigue. In health B IV stood half-way between the other two.

(C) The following table gives an analysis of the physio-

logical, moral, and intellectual characteristics of B I and B IV. It is written in the first person, the *Real* Miss Beauchamp describing her own traits, according as she is in state B I or B IV, but it has been carefully collated and discussed between us. The greater number of these contrasted peculiarities have been the object of my personal observation, and for their accuracy I can vouch. It was often easy to recognize whether it was B I or B IV who entered the room by certain plainly manifested traits, — the character of her clothes, the way her hair was dressed, her response to physical contact, as in shaking hands, and her replies to questions that brought out her moods. Even the single conventional greeting, "How do you do?" would elicit a response that left no doubt. A study of the table will suggest that some of these traits must necessarily have carried with them mannerisms that would be characteristic and unmistakable. This was the case.

#### TASTES (*physiological*)

Those marked with an \* were characteristic of childhood, before disintegration into B I and B IV took place (1893). The *Real* Miss Beauchamp has a normal memory of herself as B I and B IV and of her childhood.

(I)

(IV)

Appetite usually very poor; care little for the pleasures of the table.

Appetite usually very good; like good food.

Eat things which are considered good for one.

Eat only what I like.

Take black coffee, as stimulant (never with sugar or cream), but dislike both the taste and odor of it. The latter nauseates me.

Take coffee (with sugar and cream), and love both taste and odor.

Like milk and take a great deal of it and regularly.\*

Dislike milk and do not drink it unless obliged to.

- |  |   |
|--|---|
| Like lemonade with sugar.*   | Like lemonade without sugar ; cannot drink it if sweetened.   |
| Like soda with syrups, etc. ; do not like it plain.*   | Like plain soda ; cannot drink it with syrups.  |
| Rarely take wine, though I like it. Am easily affected by it. Never drank a whole glassful at a time.*   | Always take wine. Have a strong head, and can drink several glasses without being in the least affected. Have drunk what would be the equivalent of at least eight or ten glasses without being conscious of any effect whatever. |
| Very fond of vegetables and would gladly be a vegetarian.  | Dislike all vegetables and never eat them.*   |
| Never use vinegar.*  | Use a great deal of vinegar.  |
| Never use oil.*  | Use a great deal of oil.  |
| Like soups, broths, etc.*  | Never eat soups or broths.  |
| Cannot eat oysters.  | Very fond of oysters.*  |
| Like graham bread, rye bread, etc.   | Never eat anything but white bread.*  |
| Fond of ice cream.*  | Never eat ice cream.  |
| Cannot take sherbet.   | Very fond of sherbet.*  |
| Dislike the smell of cigarettes ; never smoked one in my life ; have moral objections to smoking and feel distressed on learning I have smoked as B IV ; have been nauseated from effect of B IV's smoking.* | Extravagantly fond of smoking, and can smoke almost innumerable cigarettes without feeling any ill effects.   |

Have a strong aversion to taking medicine of any kind unless absolutely obliged to; am almost invariably nauseated by the mere thought of taking it.\*

Am always experimenting with drugs, patent medicines, etc.

Rather averse to out-of-door exercise, though chiefly, I think, because of not feeling up to it.

Extravagantly fond of all out-of-door things, and apt to indulge in them regardless of fatigue.

### TASTES (*moral*)

Always wear hair low.

Always wear hair high; am made extremely nervous by the way B I wears it.

Cannot bear tight clothing, because of pain and discomfort.

Like clothes very tight—so tight as to cause B I acute suffering.

Like black, white, and soft shades of color in dress; dislike practically everything affected by B IV.

Never wear black—hate it; am fond of white, and, generally, of more vivid colors than B I; generally change clothes I find myself wearing as B I.

Like rings very much, and wear them.

Dislike rings; find them uncomfortable and irritating; never wear them.

Like button boots of soft flexible material; high laced boots cause acute discomfort; by choice wear low shoes.

Like high-laced boots of firm material; dislike button boots and cannot wear them without being made tired and nervous; dislike low shoes and never wear them.

Dislike sunlight and the glare of the streets; keep shades low in order to have dim light in room; am very apt to have headache if light is strong.

Love sunlight and the glare of the streets; fasten shades at the very top of the window in such a way as to make it difficult for B I to change them.

Very fond of church and of church services.\*

Never, voluntarily, enter church or attend any service.

Like devotional books and read a great many.\*

Never read devotional books, and am annoyed by having them lying about.

Never read newspapers, and care very little about what is going on in the world.

Devour newspapers with great enjoyment, and take an eager interest in general affairs.\*

Am like other people in this respect.

Dislike intensely being touched by any one, even shaking hands with any one.

### MORAL CHARACTERISTICS

(I)

(IV)

Patient

Most impatient.

Considerate of others.

Consider only myself and my personal convenience.

Even temperament, though tinged with depression; amiable; never angry.

Quick-tempered, and subject to violent rages which nothing will restrain; circumstances which depress B I arouse anger in B IV.

Never rude or intolerant.

Rude if opposed, and apt to be intolerant at all times.

Never quarrel with Sally or attempt retaliation.

Fight Sally day and night.

Never enter into a contest when opposed.

Always ready for a contest if opposed.

Nothing suggests retaliation; never take offence.

Quick to take offence and to retaliate for what would be immaterial to B I. "I wear a chip on my shoulder."

Very dependent.

Extremely self-reliant.

Strong will only in pursuing an ideal; otherwise, easily influenced and yielding.

Indomitable will and obstinacy, even if only to have own way; rarely influenced by others.

Ready to take advice, and need the moral help of control.

Unwilling to take advice or submit to any control.

Practically free from vanity and conceit.

Vain, and extremely conceited. "Imagine I am quite capable of running the world."

Rarely make suggestions, and never volunteer advice.

Am constantly making suggestions, volunteering advice, etc.

As a rule, yield to emotions.

Never yield to emotions.

Spend a great deal of time in dreaming, and lead a meditative, dreamy life.

Never spend a moment dreaming; lead an exceptionally active life.

Read a great deal, and find reading one of my greatest pleasures; have catholic tastes;

Read very little, and do not care about it; prefer books dealing with facts; care noth-

also love the beauty of the book itself as well. Fond of books of devotion, poetry, and novels. Never read B IV's books.\*

Dislike writing, and do very little.

Hate sewing.\*

Morbidly averse to meeting people, and to forming new friendships.

Devoted to old people.

Love to be with people who are ill or suffering.

Very fond of children.\*

Enjoy doing charitable or altruistic work, visiting and reading to invalids or old people, visiting the poor, etc.

Religious in thought, and lay much emphasis on outward observance. Fond of church and church services, of keeping fasts and doing penance.

Given to idealizing friends, and even mere acquaintances.

ing for the binding or form of the book. Never read B I's books.

Write a great deal and like it.

Like sewing.

Delighted to meet new people, but quite as averse to forming friendships as B I.

Detest old people.

Hate illness, and have morbid horror of everything connected with it.

I think children a great nuisance.

Hate such things.

Converse of this.

Entirely without this.

Have different set of friends from B IV, with consequent social difficulties.

Have different set of friends from B I; cannot, as a rule, endure the people she likes.

Am emotionally affected by religious services and indulge these emotions.

Also emotionally affected, but, knowing that I have been profoundly affected by these things in the past, I avoid them and all mention of them whenever possible. When not possible, I endeavor to abstract myself as much as I can in order not to be influenced and not to remember.

No fear of the dark.

Great fear of the dark.

#### ACQUISITIONS

Knowledge that was obtained by B I through study, such as French, Latin, shorthand, etc.,

was often found not to be possessed by B IV unless lost by B I.

was often not possessed by B I unless lost by B IV.

What was learned by B IV

[That is to say, these acquisitions alternated between B I and B IV: when B I could read French, B IV could not, and *vice versa*, — that is, the memory of these languages was alternately synthesized with the two personalities, but it is not possible to say it was never synthesized by both, for obvious reasons.]

*Emotionalism.* There is one trait common to both I and IV which deserves more particular mention on account of the part it played in the psychological drama of this case. In both personalities the emotions ordinarily asso-



ciated with specific experiences were felt with extraordinary intensity and rushed upon them with flash-like rapidity. Music, religion, scenery, a poem, a story, or the personality of an individual aroused intense feelings, pleasant or unpleasant, which swayed B I irresistibly and threatened to dominate IV. Even in recalling to memory a scene of the past each lived over again all the feelings experienced at the time. (The power of visualization is so marked in both that a mere verbal description of an event awakens a visualized picture of the whole.) Of the two, probably the feelings of IV were the more intense. But there was a great difference in the behavior of I and IV to these emotions. B I's life was given up to their influence. In the play of her mobile features every feeling could easily be read. But IV fought against them, trampled upon them, resisted them with all her might and main. She was determined that she would not be under the influence of her emotions, whether of religion or music, or of those coming from the personal influence of another. She indeed concealed this side of her character successfully for a long time, pretending that she was indifferent to all that really affected her intensely. Sally was completely hoodwinked by her. IV even wrote perverted analyses of her mental reactions to various experiences (music, books, religion, etc.), in order that the truth might not be guessed. She was bound that she would not be the slave of her emotions, which meant idealism, but would be free.

*Insistent ideas.* "When we examine the demeanor and thought of certain patients, particularly hystericals," says Janet, "we soon discover that their thoughts are not like those of other people. While with others ordinary ideas, sensations called forth by the sight of surrounding objects or accidental conversations, retain some sort of normal calm — their balance, so to say, along with other psy-

chological phenomena — with hystericals it is otherwise. One particular notion will at once assume an undue importance — an importance altogether out of proportion to their other ideas — and play a chief part in their lives. This fact has often been observed and pointed out by students.”<sup>1</sup>

We may say that there is a limitation of the field of consciousness in the sense that only one point of view at a time can be made use of by the subject. There is a restriction at any given moment of the total number of associated ideas. The subject is unable constantly to readjust his ideas according to the requirements of the moment; to compare and shift his point of view and thus get a balanced judgment. The content of consciousness becomes contracted to a single idea which dominates the mind. The consequence is, that the hysteric tends to be under the domination of the particular idea which is present at any given moment, while one or more tend to be persistent and may even become fixed ideas. This was the case with both B I and B IV. Whatever idea came into their minds respectively tended to dominate the judgment and control the conduct of each, regardless of the wisdom or unwisdom of the resulting act.

This was particularly the case when an idea was accompanied by a strong emotion. Then it was simply impossible for either personality to see any other point of view. Argument and expostulation were in vain, and what practically was equally inconvenient, nearly every act or word of others was interpreted from this point of view. The only remedy was hypnosis and suggestion, and then in a moment all would be changed.

This incapacity correctly to interpret the environment is a marked peculiarity of certain types of the hysteric mind, but one which is generally overlooked. The hysteric given over to insistent ideas is unable correctly to interpret his

<sup>1</sup> The Mental State of Hystericals.

environment. His perceptions are perverted, owing to a faulty translation of everything through his own ideas. Visual and auditory images are aroused in his mind with abnormal vividness, and in consequence the ideas associated with any given perception, especially when of an emotional character, are revived with an undue intensity and give a distorted meaning to the perceptions. The associated ideas fill his conscious field instead of the perception. This largely accounts for the supposed lying to which in text-books hysterics are erroneously regarded as prone. They do not intend to lie, but simply narrate their own distorted perceptions.

This domination of ideas in B I and B IV tended to greatly add to the difficulties of the management of the case. It interfered with the daily routine of life and led to the assumption of responsibilities and tasks far beyond the strength and capacity of either personality to fulfil.

There was one other very curious peculiarity in the relations of B I and B IV, which has already been described but which should be mentioned in this connection. It had, moreover, certain practical results, both in the undoing of the personalities and in their restoration to normality. It was this: though B IV and B I had, respectively, amnesia for the ideas and sensory experiences of each other, the *emotions* of the one awakened by such ideas and experiences were often retained by the other, and were, therefore, more or less common to both. If, for instance, B I for some cause became anxious or fearful about some particular matter, when she changed to B IV the latter felt anxious or fearful without knowing why. The resulting phenomenon was much like one of those obsessions of which I have already spoken (Chapter VIII), and which play such a prominent rôle in clinical medicine. Although B I and B IV as personalities were not subconscious — in the sense in which this term is used in this study — to

each other, yet certain isolated, disconnected, "scrappy" memories of each sometimes persisted and formed a consciousness to the other. At least there is experimental evidence tending to show this. The emotions of the waking personality, then, came from the subconscious memories, just as did *B I*'s indefinable fears before the advent of *B IV* (p. 133). Finally, the effect of the same emotion produced interestingly different results in the two personalities. In *B IV* worry or anxiety produced insomnia or fatigue, which in turn excited bad temper. Then all good resolutions were thrown to the winds; all sorts of obsessing ideas arose; the world was against her, and she was against the world and defied it by rebellion. On the other hand, in *B I* the same emotion produced insomnia and fatigue also, but instead of bad temper there followed depression, weariness, a feeling of helplessness, penitence, and recourse to prayer. The following instance will illustrate:

*B IV* had temporarily reformed. Suddenly, and apparently without motive, she became angry, rebellious, belligerent. After passing most of the night, as a relief for insomnia, in writing some records for me, she pitched the whole thing into the fire in the morning, in a fit of anger. When reprimanded, she complained of a feeling of anxiety and dread, unconnected with any known idea, and of the origin of which she was ignorant. It was a distinct feeling of being anxious about something, but she did not know what that something was. It was discovered through hypnosis (by methods to be described in the next chapter) that *B I* was anxious about a particular matter. Her apprehension was so intense that it induced insomnia, but, saintlike, she sought relief in prayer and church. *B IV* did not definitely know what the trouble was, but she, too, felt the anxiety, which likewise in her induced insomnia; her relief was not prayer and church, however,

but anger and the destruction of the records. The evidence obtained showed that it was the same emotion that was experienced by both B I and B IV.

These extraordinary differences in the characteristics of B I and B IV furnish data for determining the psychology of character of which we shall make a further study in Part III. That a person's character may change in a moment, becoming in a second of time the antithesis of what it was, opens up the questions, What is character? and, What makes character? The phenomena of disintegrated personality suggest that our characters are wholly a matter of brain associations, and that they may be altered for good or for ill, by anything that will bring about a rearrangement of these associations.

At first in the course of this study it seemed as if the differences in character between B I and B IV might be determined by differences in memory. It has been held<sup>1</sup> that disorders of character are dependent upon disorders of memory; but when one studies the differences in the *physiological* reactions manifested by B I and B IV it seems inconceivable that they can be brought about by differences in memory, as that term is ordinarily understood. Surely the susceptibility to alcohol of B I, who felt uncomfortable from one glass of wine, and the immunity of B IV, who has taken without conscious effect three or four glasses of champagne, followed by as many cocktails and several glasses of liqueur, cannot be explained in any way by memory. Nor can the differences in tastes, such as the fondness for sugar, oil, vinegar, etc., on the part of one personality, and the dislike on the part of the other for the same things, be made intelligible on the ground of memory, in the absence of any known experiences, pleasant or unpleasant, in connection with them. Miss Beauchamp can recall nothing that

<sup>1</sup> Pierre Janet, *The Mental State of Hystericals* (1901), p. 78.

would suggest a reason for these differences. The varying hyperesthesia in the two personalities, such as the intense dislike of being touched by another person, the dislike of finger rings and buttoned boots, manifested by B IV, and B I's dislike of tight clothing, high-laced boots, etc., cannot be explained on the basis of memory. The same is true of B I's depression and of its absence in B IV.

Even when we include in memory all the half-consciously associated experiences, ideas, and emotions grouped about any particular thing in the object world, it is difficult to understand through such associations the different reactions to sunlight and color which we find in our table. These led to differences in habits and in dress; peculiarities which plainly enter into at least the "caprices" and "whims" of the subject. And what shall be said to explain through memories the differences in the religious feelings? Each personality remembered their mutual early life, when the religious education took place. And when we pass to moral and intellectual attitudes, which essentially belong to character, the memories must be exquisitely subtle that can oppose vanity to unconsciousness of self, quick temper to serenity, and indomitable will and mule-like obstinacy to yielding docility.

It seems to me that such great differences can be explained only through differences in the reactions of the mind (or brain) to the environment; such differences in the reactions being due to dissociations of mental processes and reassociations of them in new systems of mental states. The cards, so to speak, have been reshuffled and a new hand dealt.

That B IV is a very different character from the Miss Beauchamp who first presented herself in 1898 must be plainly manifest to the most casual reader. But did the change portend a return to a previous state? The extreme

mobility of the psychical states, the suggestibility, the readiness with which dissociation took place, and the ease with which she was influenced by the subconscious state (Sally), implied an unstable condition and tendency to disintegration, and were against normality. But B I showed the same peculiarities, and between the two in these respects there was nothing to choose. If mobility, dissociation, and suggestibility were taken as criteria, B IV was quite as normal as our Miss Beauchamp, and quite as likely to be the real original self.

On the other hand, many of IV's other characteristics, especially the absence of aboulia, the lowered impressionability and emotionalism, the lessened neurasthenia, the self-reliance, etc., etc., pointed to a greater degree of normality, with the possibility that she was the real self.

The more the two personalities were studied, the more abnormal both appeared, and the less there seemed to choose between them.

## CHAPTER XVIII

### IS B II THE REAL MISS BEAUCHAMP?—B I a

DECEMBER, 1899, was passed in studying B II. The best idea of B II can be gained, I think, if her mode of speech and manner when she makes her appearance are described, as well as the way in which it is customary to bring her. B II never comes spontaneously, like B I and B IV. When the other characters change parts they do it with one another, never with B II. It is necessary to bring B II by word of command. B I or B IV, as the case may be, is hypnotized in any one of the conventional ways, — a word of command for the eyes to close and for the personality to sleep being ordinarily sufficient. Then the command, "Change; B II," is given, and if successful B II is there.

As a test of identity I have been in the habit of putting certain questions which are answered differently by each. Not only the answers but the manner of each is so different that it is almost impossible to mistake the character. Sally, as a joke, used sometimes to imitate B II, but the imitation was so poor it was easily detected. B IV at a later period, being in rebellion against the new order of things, would try to prevent my getting B II, and at times while *apparently* half hypnotized<sup>1</sup> would claim that she was B II, but a single test question of memory would settle the matter, aside from her mannerisms, which were as different from those of B II as, we will say, Sarah Bernhardt's

<sup>1</sup> At such times, as will later appear, B IV was in another hypnotic condition, B IV a and, correspondingly, B I in what was known as B I a.



from Duse's. But aside from these times of active rebellion and war, when the question, "Who is this?" was asked, if the change of personality was not complete, the answer would be, "B I" or "B IV," as the case might be, the individual being in what seemed a half-hypnotic condition. When the change was complete, the answer would be, "I am myself," or "I am Miss Beauchamp." There was a quiet dignity in her manner that was impressive. Then would follow the colloquy already mentioned:

"Where is B I?"

"I am B I, Dr. Prince."

"Where is B IV?"

"I am B IV."

Every attempt to confuse her would fail, and she would never allow one to make any distinction between herself and these personalities, or even between B I and B IV. She recognized the fact that she behaved differently in the respective rôles of B I and B IV, but I could never speak of B I or B IV as such without being reminded that it was herself; consequently I was obliged, as a rule, to use some such phrase as, "You as B I," or "When you were B IV." She insisted, in sorrow, upon assuming full responsibility for B IV's conduct, saying that it was herself after all, and she could not shirk the responsibility. She recognized the fact that as B IV she did not know what she did as B I, and *vice versa*; but she, B II, knew everything.<sup>1</sup> She could give no explanation of the metamorphosis from one to the other of the personalities, or why at one time she could not remember what had been done at another time.

Then, as a character, she was in many respects different from B I, and totally different from B IV. With a full knowledge of the past six years, the spectacle of herself as B IV rebelling against her friends, fibbing, and prevaricating, was a source of great pain to her; and when later

<sup>1</sup> Excepting, of course, about Sally.

B IV plotted to get rid of all control, terrorizing B I into a belief that every one was tired of her, B II would beg not to be given up, not to be allowed to leave us, not to be deserted. She would ask, "Why do I behave so?" and then plead not to be permitted to do it. She would humbly apologize for her conduct, which she took deeply to heart.

In character B II seemed to answer all the requirements of the Miss Beauchamp we were in search of. She was without the morbid idealism and impressionability of B I, and without those traits of B IV which all recognized to be departures from the original self. But of course, as she had never been allowed to live a life of her own, independent of the other selves, had never indeed opened her eyes, what kind of a person she would be, how she would behave, how she would react to her environment, if her eyes were opened, could not be foretold.

It was evident that B II had developed in many respects since those early days, nearly two years before, when she was described as the soul of Miss Beauchamp. She still seemed to be that, but she was more. There was an absence of that melancholy sadness and weariness that had formerly characterized her. She was less nervous, showed less humility, less morbid conscientiousness; she was more natural, more light-hearted, and possessed greater spontaneity and intellectual grasp. The significance of this change, which was ascribed to psychological growth following wider experience, was not recognized for some time. When the true explanation was found the problem acquired wider proportions. B II then had apparently grown into a character differing almost as widely from B I as from B IV.

Two hypotheses were now admissible: (1) B I + B IV might be the real self, that is, B X (not yet found); (2) B II might be the actual real self, but in hypnosis, which self became disintegrated at one time into B I and at another into B IV. In either case it was plain that B II was

not a hypnotized fragment of B I or B IV alone, for she had a larger field of consciousness than either, and her memories included the memories of both. The real self, then, might be X, some one we had not yet seen, or it might be B II awake. If the second hypothesis was the correct one, then B II would be the real self (in hypnosis) whom I had been hunting for. Under both hypotheses B I and B IV would each be mutilated selves, parts only of the real self, each a sort of somnambulistic personage.

It was quite possible, however, that the hypotheses were not exclusive of one another, but that both hypotheses might be correct; which would mean that B X (or B I + B IV) in hypnosis was B II.

We have spoken always of B I and B IV being hypnotized into B II. According to the second hypothesis, as B II was a synthesis of B I and B IV, the process was in part the reverse of this; instead of being hypnotized into B II, B I and B IV would be each partially waked up when changing to B II, — partially, because the person was in hypnosis. The *process*, instead of hypnotizing, would be one of awakening into real life, because it was a synthesizing of dissociated groups of mental states. Conversely, when B II was said to wake up, what really happened was that she became disintegrated. Her mind became cleft into two dissociated systems, one system representing B I and the other B IV. From a technical point of view she would be said to go into two somnambulistic conditions respectively. Whether she went into one state or the other was apparently a matter of chance. If the cleavage was in one direction she became B I; if in another, B IV. In each state certain portions of the mind or brain became dormant. The first of the new hypotheses also involved a similar cleavage of B X into B I and B IV.

It remained to test the hypotheses. If B II was the real self asleep, it would be necessary only to keep her

herself and have her open her eyes and awake, and she would straightway walk forth resurrected, whole, and un-mutilated. In spite of the risks I determined to try the experiment.

One day B II was brought. After talking to her a short time, I said, "Listen to what I say. I want you to open your eyes; to remain yourself as you are now; not to change to B I or B IV, but be yourself," etc.; then finally I commanded, "Open your eyes." Her eyes opened. She looked about with a vacant look on her face. She did not know me or the room. She knew very little about herself, or, in fact, anybody else. She said she must go, but did not know where she was going or where she lived. Her mental associations were completely dis-organized. She seemed to be a dement.

The experiment was plainly a failure. It was evident that she could not be allowed to go about in that state, so I closed her eyes again and brought B II, who, however, could throw no light on the matter. She did not know why she had developed such confusion when her eyes were opened, though she remembered the fact of having been a moment before in that condition. The experiment was repeated later, but again failed.

It remained necessary to test the first hypothesis and see if B I and B IV could be blended into one personality, — the real self.

This is a good place, before describing the results of these experiments, to record another discovery, although it was not made until a much later period. This discovery explained the apparent change that had taken place in the character of B II, and her identity with B VI. *Our present B II was not the original B II*, the hypnotic self which appeared the first time Miss Beauchamp was hypnotized, before Sally's advent.

It will be remembered that the original B II was described as a passive hypnotic state, having for the most part the characteristics of B I and into which the latter went when hypnotized. Later this B II was replaced by Sally and very little was seen of her until about the time when the discovery was made that B I and B IV became the same when hypnotized. It was assumed that the resulting hypnotic self was the same as the original B II, though the differences which have been pointed out were noticed. The changes in character were attributed to the effect of education, as they well might be. But as time went on it was found that while the original B II was plainly B I in character, the present B II showed distinct differences, which became more and more marked as Miss Beauchamp's trouble subsided. She did not have the saintlike attitude of B I any more than she had the belligerent irascibility of B IV; rather, she exhibited a well-balanced poise of mind which spoke for normality. She was not only simple and truthful, but her point of view was plain common-sense. The suspicion arose that the original conception of B II was erroneous, but later the *original state reappeared*. It was then found that this state was an entirely different one from the New B II with which we had been dealing of late. The test of memory alone proved this. This original state which frequently reappeared had no knowledge of B IV, as the New B II had.<sup>1</sup> She knew only herself as B I, as formerly was the case. In character, too, she was easily recognized as the original B II: there was no mistaking her. In other words, she was only B I hypnotized; she in no way partook of B IV. It seemed best then to rename the original hypnotic state, *B Ia*.

From these observations it was plain that B I when hypnotized went into two different states: B Ia, and B II (= B VI).

We may construct a scheme to illustrate the relations to

<sup>1</sup> Nor of the New B II.

each other of the different psychological groups and the memories which each possessed, dissociation being indicated by *broken* lines and synthesis by *solid* lines :

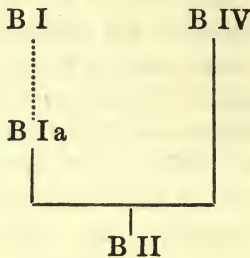

The memories of B I a were not perceptibly broader than those of Miss Beauchamp, but if the process of "hypnotizing" was carried farther, a very great change took place. The memories of B IV became added to those of B I, and she became B II; so that in this rearrangement of the mental groups there was more than a dissociation (hypnosis); there was a putting together of the memories of previously dissociated groups (B I and B IV).

Later still, as will appear, it was found that B IV could be put into a hypnotic state corresponding to B I a, and this state was named B IV a. It played a very important and obstreperous part in the solution of the problem. As with I a, when IV a was still further "hypnotized" (really synthesized), it became B II.

We could then add to our scheme as follows :

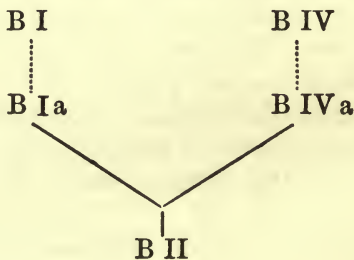

It had been hoped that by waking up B II the real self would be obtained. This experiment had proved a failure, for on being awakened B II became only a sort of dement. That she should be such was a paradox. The question now was, Can B I be synthesized with B IV, and will the resulting personality, X, be the real self? If so, it would follow that by the disintegration of B X, B I, and B IV had resulted. Our scheme might then hypothetically be thus enlarged :

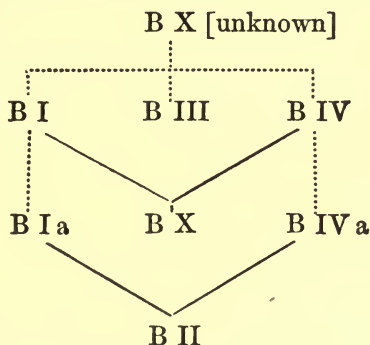

It is to be understood that these symbols represent alternating or successive states, and not contemporaneous states.

A series of experiments was now undertaken with the view of synthesizing the memories of B I and B IV by means of suggestion to B II. They were interrupted by the outbreak of family rows which compelled the postponement of the study. As far as they went, some very interesting results were obtained. As these experiments were resumed at a later period, the details may be deferred until those more complete observations are described. It may here simply be stated that it was found possible by means of suggestions to B II to bring back to B I and B IV, respectively, memories of specific events in the life of the other; in other words, to synthesize specific mental states. Beyond this at this time the experiments were not carried.

## CHAPTER XIX

### SALLY HYPNOTIZES B IV AND FIGHTS FOR CONTROL

WE must now take up again the thread of Miss Beauchamp's life.

During the autumn and winter (1899-1900), while these studies were being made, the vicissitudes of a triple personality were going on. Sally had largely transferred her interests from B I to B IV, whom she liked better. Leaving B I, whom she regarded as a weakling, a sentimentalist, to go her own way alone, she expended her energy on B IV, whom she persisted in hazing as she used to haze B I. It must not be thought that Sally was actuated solely by a desire to annoy and torment; that was not her idea. The trouble was that she found the daily life of B I and B IV dull and boresome, and, as she used to say in reply to remonstrances, "What is there for me to do?" Tormenting the others was a game which, childlike, she delighted to play. She could n't sit at home, twirling her thumbs and doing nothing, and so she occupied the time writing notes that would bring a return volley on her head; or in doing or undoing, as the case might be, something which the others disliked or liked, if only the arrangement of the furniture in the room.

Then, too, she wanted her way as much as the others wanted theirs. She would promise again and again to have no intercourse whatsoever with the family, but, as she used to say even while promising, she could not keep promises of this kind. It was really impossible to provide her with amusement. The outdoor sports, the adventures, and the



strenuous life which she loved were impossible for Miss Beauchamp. One can imagine the difficulty of providing three kinds of lives, for one and the same individual, to be pursued at different hours, and even the same hour of the same day. The result was that Sally, having nothing to do, found her enjoyment in teasing the others. She did not hate IV as she hated B I; with IV it was more the excitement of playing the game. Then too, IV took it all differently from what B I did. B I was terrorized by Sally. IV was unterrified, defiant, determined to be mistress of herself. "If Sally is only a part of myself," she would say, "I will conquer this thing;" and she insisted on fighting it out. Sally, on her part, would say, "I cannot frighten her as I can Miss Beauchamp," at the same time pointing out that she herself was at a great disadvantage because she did not know IV's thoughts. Sometimes one would get the upper hand, and sometimes the other, B IV's point of weakness being that B I's anxiety and her own battling would bring insomnia and fatigue to the family body, and then, her physical strength going, she would become temporarily discouraged, but never for a moment thought of yielding.

She was able to take advantage in an ingenious way of Sally's ignorance of her thoughts. Believing that Sally was watching and listening, spying upon her every act, and ready to infer her thoughts and motives from what she did, she would do all kinds of things to mislead Sally as to her own real character and intentions. She would lead her on false scents, give her, to use the slang of school parlance, "crooked steers," making herself appear by her words and acts heartless, without emotion, and indifferent to everything that Miss Beauchamp held dear. Once or twice at a somewhat later date (June, 1900), Sally, by a device, discovered IV's thoughts, and then her astonishment at the revelation was extreme, for she found them very different

from what she had imagined. The same surprise constantly awaited her when accidental discoveries revealed IV's real motives and intentions. IV would go to no end of pains to deceive Sally; as, for instance, one day, being much distressed by a certain event, she wound a cloth around her head, as if it were a headache that was oppressing her and not her mental agitation.

Sally used at first to take things *au pied de la lettre*, but later caught on to IV's dodges. One difficulty one always had to contend with, namely, Sally's childlike credulity. IV would play upon this, telling Sally all sorts of things in order to circumvent me and bring about her own ends. "IV says you really don't want me to do" so and so; "IV says you want this"; or "IV says that," Sally would say, — each thing being directly contrary to my wishes, and generally of great importance.

IV and Sally kept up a mutual correspondence, which was carried on sometimes by Sally's using IV's hand and writing automatically as a subconscious self, and sometimes by writing in the waking state, as the personalities changed back and forth. IV would in this way artfully make use of Sally to keep herself informed of all that took place when B I and Sally were in the flesh, in return for which information she would throw Sally a sop in the way of a present, or acquiesce in some particular forbidden fruit's being plucked.

Sometimes the two would engage in bickerings, like two squabbling children, each scribbling cutting remarks and retorts to the other. On some of these occasions, coming unexpectedly into the room, I would find pieces of paper scribbled over with conversations of this kind. Sally was obliged to write her own little pleasantries, but IV could communicate hers by speaking aloud; so Sally would hear many a little muttered, left-handed compliment, as well as matters of interest. "Little beast," or "Fool," IV would

mutter ; or, if in a friendly mood, words of information or advice.

There were times when IV and Sally would enter into systematic campaigns of hostilities, each determined to down the other. Then IV would gird on her armor, and set forth resolute, uncompromising, with blood in her eye, determined to suppress Sally for good and all. She would do her best to destroy everything that her enemy wrote — many a letter to me was destroyed — and to undo everything done. Whatever she discovered Sally was doing, or imagined she was doing, she would reverse. If, for example, she found herself on the way to my house, she would turn about and retrace her steps, or at least would try to do so, for Sally, in her rôle as a subconsciousness, would at once make a dive for the muscular steering gear, there would be a temporary struggle with arms and legs, a sort of aboulia, and then it usually happened that Sally, victorious, would reverse the machinery and head her again for her destination. At night, too, Sally would have another turn. As fast as IV would get into bed, Sally, coming herself, would get up, and then, changing herself back to IV, the latter would find herself to her disgust out of bed again. And so it went on all night ; and if IV got off without the bed and furniture being turned upside down, she was lucky.

Then again Sally would refuse to write IV a line of information, thus leaving her in the dark as to the course of events. This would worry IV more than the hazing, for without information she was lost. At the end of about two weeks of hostilities IV would appear, with her plumage plucked, like the historical parrot after the scrap with the monkey, and then, thoroughly worn out, she would consent to my mediation. But during it all poor B I would come from time to time, to find before her the mortifying evidences of her other selves' behavior.

The continuing difficulties arising from the correspondence with Anna and others added to the confusion. Sally, upon whose shoulders the culpability must be placed, was in constant communication with forbidden correspondents, to Miss Beauchamp's annoyance. They must have been sorely puzzled, not to say distracted, by the contradictory actions of the family. All this correspondence, harmless in itself, might have been disregarded if it had not given encouragement to Sally's independence.

But aside from this particular influence, when, as was at times the case, Sally passed the bounds of all control, there was one card which it was possible to play with telling effect. In such emergencies, when B I or B IV was driven to distraction by Sally's hazing, I would threaten to lay the whole case before one high in authority. Sally, remembering the past, and terrified by the danger which threatened others, would thus be brought to her knees and reduced to submission — for about two weeks!

Some knowledge of all this is necessary to understand her correspondence, and the other scraps of writing which are included in this account. It will also enable one to understand some of the difficulties in the way of therapeutics, which at times made it impossible to pursue any systematic method of care, and even of experimentation.

Here are some scraps I surprised IV in the act of writing, while Sally was trying to reproduce automatically some of the destroyed autobiography:

“My precious Sally — Have you eaten my manuscript? If not, kindly produce it. I am *waiting*, and so is the doctor.”

“Ah ho! Ah ho! wake up Sally, *You are afraid*.  
But oh the fear lest a thought should” —

“O Sally dear, my lips shall be mute if you will only come back to me. You may have the [photograph] frame and all else that you wish.”

Here are two notes written by Sally, but apparently to Miss Beauchamp rather than IV:

“ Amen  
 Thou has sinned,  
 Thou hast done amiss and dealt wickedly,  
 Amen The sorrows of death shall compass thee about. Amen ”

“ Amen  
 The pains of hell shall come upon thee,  
 Amen Thou shalt find no help,  
 Amen No comfort in heaven or in earth.”

S. B.

[To B IV.]

“ My Chris she hauls me round the house,  
 She hoists me up the stairs.  
 I only have to will her,  
 And she takes me everywhere.”

“ Because she loves me so.

“ Written by Sally’s friend, G. B.”

“ *FOURTEEN*<sup>1</sup> in one day, you abandoned little wretch!  
 And after all you have n’t deceived them. You are reckoning  
 without S. B. She corrects all your errors for you.”

The last three were found by B I and inclosed in the following note to me. There was also inclosed (either accidentally or by Sally) a fragment, the eleventh page of another letter to some one else.

“ Can I see you for a few moments some time this week? Wednesday afternoon, if possible? You misunderstood my impatience yesterday; it was not with you — only with myself, and my own weakness.”

[Fragment of letter from B I to Z——.] “ But sometimes the weight of this strange curse presses so heavily upon me that it seems as if it would crush my very life out, and I hardly know what I say or what I do. And it tires me so! You know how long it has lasted — how great the strain. . . .”

<sup>1</sup> Lies.

Unlike B I, B IV had a fine appetite and liked good food. Sally frequently guyed her on this human weakness. One day IV, coming to herself, found herself contemplating with great interest the following nonsense verses:

“ The greedy piglet !  
 See her mug  
 Upturned to suck  
 The honey jug.  
 Oh, shame !  
 Oh, shame ! ”

After writing this poetic reflection (whether original or not I do not know) on IV's carnal appetite, Sally had changed herself to IV to enjoy the result.

Here is a note from Sally to me, after her first attempt at the autobiography, describing her difficulty in analyzing her thoughts as a subconscious self and making clear how they ran synchronously along side of Miss Beauchamp's thoughts. On the outside of the envelope was written: “B IV *is not* a person. Why do you all insist that she is? I know she's rattled.”

“ Can't you *somehow* make me more clever, so that I can write this old thing decently? It really is n't half expressed, and the nasty thing won't say at all what I mean. Perhaps it would be better if I divided the page [into parallel columns] and carried it on that way, would it? That was really the way the thought went, you know, until I got my eyes open. She could correct her side if you wished — if you think she would be more accurate.

“ B IV will probably have a very woeful tale to relate when she sees you. She thinks the millennium farther off than ever, for I have made her sick as a little dog on cabanas [cigarettes]. I want her to realize the superiority of her better self. Is n't it awfully good of me, for I'd heaps rather smoke them myself, you know? She's too done up to be even cross.”

A failure on my part to recognize the manuscript of the autobiography, and the consequent scolding of Sally over the head of B IV, brought this wrathful letter from the former:

“Autobiography.

“If you no longer want it, please put it in the fire. I'm *not* repentant, nor sorry for my sins, nor anxious to comfort the poor afflicted family. They may go to the devil.

“Amen, amen.”

[From Sally to B I.] “You may tell Dr. Prince that III is absent from home on a scouting expedition for Dicky, and that you don't know when she will return. Repeat this exactly, but don't show him this paper or you may be very, very sorry. I do not choose to be psychologized by any one.

“Amen.”

But Sally soon became alarmed by the consequences of her pranks, which resulted in making IV ill and spoiling her own fun. Sally's confession is contained in the following letter, which aroused IV's indignation when she read Sally's insulting reference:—

[Sally to Dr. P.] “You won't be cross with me, *please*, if I confess that I've been teasing B IV lately—much more than she told you about. And I am beginning to be afraid that it has n't been very good for her, for she seems to be getting all tired or sick or something. What shall I do with her? She is n't a real person—I know she is n't; yet one cannot help feeling sorry for her sometimes, she is so perfectly helpless. Perhaps I'm responsible for some of her bad temper, too. I may as well tell you everything. But she is the most exasperating monkey you ever saw. One needs must take her . . .”

“Thursday. [January, 1900.]

[From Sally.] “Many thanks for your note. Being a brick is loads nicer than gaining a moral victory. I hate morals and victories too. Do you know Dicky and I are great friends

now. I go to see him. He does n't consider me a subliminal at all, on his honor; and I may stay, and he's going to hypnotize me to get at the real subliminal. Isn't it amusing? Will he call it B V, and will he make it tell him all about me? I think it's awfully funny, but I can't conceive of things being done without my knowledge, even in hypnosis. They never have been, you know, since that very, *very* early time when I used to sleep. Shall I tell you more about the experiments as we go on, or do you prefer getting it all from Dicky's point of view, as more scientific? Perhaps I may not know much about it anyway, except the things I do to [B] I and IV.

"Which of the family do you want to see to-morrow? You have a wide choice — I, II, III, IV, and V, if Dicky gets it. I is blue; II fuzzling; III —; IV cranky. IV is also disturbed, enough so to lie awake all last night because of Mr. C.'s determination to have her confirmed this year. She never has been, you know; but it is really impossible now, for she's not fit. She's always erring and straying. She can't be confirmed, Dr. Prince — you know she can't, for she is n't going to stay. B I won't like it. I never dreamed of your knowing Mr. C. Please say she must not be confirmed. I'm sorry this is so long, for I see you are awfully tired, but I wanted just to tell you these things. Shall I go on with the writing, or is it too bad? Please leave the books for me. Dicky says anything will suit him. He won't be critical, and he is very anxious to have it. Not from Sally Beauchamp but from [here Sally writes her real name].

"Le roi est mort. Vive le roi!"

[January 24, 1900.]

[From B IV.] "It is really too absurd for me to bore you with complaints of Sally, for I know you think I deserve all I get from her, and perhaps I do. I won't come again or write you. My only thought in asking you to let me come regularly and tell you everything that had happened was that by so doing you might perhaps control both Sally and myself and make one real person, as she would say, out of us. I know she does n't think very much of me. I don't myself. I know that what she says is true enough. I am perfectly unresponsive to all the things



that used to touch me most nearly.<sup>1</sup> Not that I care, for I don't; yet I am conscious of my deficiencies, and I suppose they are what trouble her. Emotionally and spiritually I am dead, although still knowing that I ought to feel and to do certain things. But I *don't* feel them and I *don't* do them. Why? I cannot say. I had hoped that you could, and that you would help me. You seem to know so much. But I am afraid I have taxed you beyond all reason. You must pardon me for being so inconsiderate. Very truly yours,"

[From Sally.] ". . . She's [IV] so stuffy. . . . She's spending all her allowance on carfares. I call it sheer extravagance! I've taken her stamps away so she can't write you again. You are glad of that, are n't you? It's such a bother when you are busy to keep getting letters."

On February 4 some interesting psychological phenomena were observed. They are too complicated to make it desirable to interrupt this narrative with a detailed account of them. But the important thing is that Sally was told to hypnotize IV and bring B II. This Sally did, but her influence was not complete, or else she did not go about it right. At any rate, instead of obtaining the real II she put IV into what Sally called a half-hypnotic state. In other words, IV was disintegrated into another quasi-personality. In this condition B IV was half hypnotized,—disintegrated, or "rattled" as Sally expressively called it,—was very confused as to her surroundings, and scarcely recognized any one, but replied to all questions by simply following leads and answering as it seemed to her she was expected to do.

As will appear when we come to study disintegration, it is possible to break up temporarily B I, B IV, and even B II, so that they will lose their cognition of surroundings, and many of their chains of memory. These different

<sup>1</sup> This whole statement is a characteristic lie, and intended equally for Sally's consumption.

disintegrated states of consciousness might then, if one chooses, be numbered, and possibly educated into personalities, if a sufficient quantity of consciousness persisted.

Now making use of Sally to influence IV was playing with edged tools, for Sally was so delighted when she discovered her "hypnotic" power that she immediately proceeded surreptitiously to make use of it. She kept putting IV into this "half-hypnotic state" and then, the better to make her enemy realize her power, wrote her a letter saying that she could hypnotize her, had done so, and would do so again. In this Sally was diabolically clever; for it was for the deliberate purpose that she might make IV conscious of the fact that she was being hypnotized, and therefore in Sally's power, that she did the deed by means of a letter, copying the method and the exact words I once employed to overcome insomnia in Miss Beauchamp. The letter ran as follows:

"Tell M. P. to chase himself, Becky,<sup>1</sup> and, as you read, slowly, slowly, your lids grow heavy — they droop, droop, droop; you're going, going, gone."

When B IV opened the letter and read it, she promptly went into an hypnotic trance. This effect of this written suggestion I had the opportunity, though unintentionally, of corroborating. Wishing to record the letter with my notes, I read it into the phonograph in Miss Beauchamp's presence. As she heard the words, the expression of her face changed, her lids drooped, and she went again into a half-hypnotic state.

To hypnotize thus either of the other personalities was too dangerous a power to leave in Sally's hands, so of course Sally came in for a good drubbing for her behavior and never to my knowledge tried her hypnotic power again. But meanwhile IV was much perturbed at finding

<sup>1</sup> Becky Sharp, one of Sally's nicknames for IV.

the battle going against her and herself in Sally's power, and as usual the final result was mental agitation, headache, and insomnia.

It was at the end of the investigation into these goings on and the various psychical phenomena manifested that there were witnessed some very amusing hallucinations in IV induced by Sally. But more important from the point of view of guardianship, my authority became endangered and I found myself engaged in a battle for control; for Sally, having defeated IV, turned her guns upon me. It was evident that either Sally or I must be master. If I gave in, my authority was at an end.

It came about in this wise. I had endeavored to change IV into B II, but could obtain only the hypnotic state B IV a,<sup>1</sup> evidently prevented by Sally, whose hand was apparent from certain characteristic manifestations. It ended in Sally's coming instead of B II, and I proceeded to lecture her on her conduct; but while in the act of doing so she cleverly escaped by changing herself back again to IV. To this personality an attempt was made to explain the situation.

"Sally has been behaving very badly," I began.

IV repeated the sentence as she heard it, the words being transformed into others having an opposite meaning.

"Sally has been behaving *beautifully*."

"No," I said, "*badly*."

"Yes," she repeated, "*beautifully*."

"No, no; *badly*."

"Yes, *beautifully*."

"No; *badly*, not *beautifully*."

"Yes, I understand; *beautifully, beautifully*."

Thus for the moment I was circumvented. It was in vain that I sought to make her hear the word "badly." It became apparent that Sally twisted in her mind every-

<sup>1</sup> Chapter XXVII.

thing that I said so as to give it an opposite meaning. She became deaf to certain words (negative hallucinations) and heard in their places other words of a different signification. Everything that was said in criticism of Sally she heard and understood in Sally's praise; she even said repeatedly that she liked Sally, had no fault to find with her, was reconciled to her, was perfectly satisfied with her, and so on. Finally she ended by refusing to obey, asserting that she was her own mistress, would go where she pleased, and do as she pleased. This, too, was plainly the work of Sally, who had taken possession of her tongue. But most dramatic was the assertion of her own personality in the midst of these sentences. Every now and then, like one pursued by an invisible demon, and as if momentarily she had broken away from the power that bound her, she would exclaim, "Don't let me speak like that!" and then the next instant she would give utterance to Sally's words.

It was impossible to make her understand anything derogatory to Sally, or even the directions I gave for her own guidance. However, I was not to be beaten so easily. Sally, as already told, had often been defeated by being hypnotized with mock ether. It occurred to me that possibly I could produce the same effect on Sally while she was still a subconsciousness; that is, while B II was present. My scheme was to hypnotize B II and at the same time hypnotize Sally as a co-consciousness, by the suggestion that *both* were being etherized. Accordingly, Sally not suspecting the ruse, I obtained B II, and then, after a suggestion or two, I went through the form of shaking a bottle of suppositious ether, pouring it on some cotton, and holding it to her nose in a professional way. At the same time I repeatedly gave the suggestion, "This will etherize Sally. Sally is now feeling the ether," etc. At first there was a struggle, then her muscles became relaxed, her

breathing deep, and she was in an apparent deep narcosis. I was now able to give my instructions, which were received without resistance or perversion; but more important was the fact that Sally was completely beaten. It was a moral and physical victory. Later, when Sally awoke, she admitted defeat, and that she had been "etherized" and "squeezed;" that is to say, her will overcome. Her word of honor was given that she would write no more letters, would not interfere with B IV, would not hypnotize or tease her, — in short, would leave her alone. In fulfilment of this promise the next day a letter arrived which laid bare the inmost thoughts of her own soul, as well as those of Miss Beauchamp as Sally knew them. I give only an abstract:

[“February 5, 1900.”]

[From Sally.] “. . . You really are mistaken in fancying that I am jealous of any one, excepting occasionally of Miss C. I hate B I, not because of Mrs. X.'s feeling for her, but because of *hers*. She [B I] loves her so much more devotedly and reverently than I ever can with all my willing. I am not jealous of her — how could I be? — but I *envy* her. I *envy* her. She is infinitely beyond me — always — even in her pain and suffering. . . .”

[Signed with real initials of Miss Beauchamp.]

“P. S. Please believe that I want to help you, and don't be cross with me again. I don't want you to be ever.”

The following shows the acuteness of Sally's mind in both observing and interpreting: —

[February 8, 1900. From Sally.] “If Becky has really reformed, why don't you make her write out some more things? For instance, the visions are presumably common to both her and B I. That is, B I remembers all that she herself has, and all that B IV has. B IV remembers her own, and we all believe that she remembers B I's too. But if she does remember

B I's, why is it that she insists that she has never had but one vision concerning ——? Do you believe it? . . . Is this a sensible note?"

[True initials signed.]

"Dicky says what I got Saturday is B n."

The instability of B IV is brought out by the varying moods which she would exhibit from day to day. One day she would appear contrite and reasonable, ready to cooperate and to do her part to bring about a synthesis of the dissociated mental states, and thereby effect a cure. Then the next day all would be changed. She would present herself as an angry, belligerent, unyielding, and uncompromising foe, and perhaps after having thrown into the fire the records of herself which she had laboriously written as a contribution to this study.

Sometimes the exciting cause of this change of mood would be found to be an emotion of anxiety or fear which had welled up into her consciousness from out of the nowhere, and was unconnected with any specific idea, but which could be traced to a similar emotion in the mind of B I, but aroused therein by some specific idea. As already pointed out,<sup>1</sup> though in B I and B IV there was a dissociation of experiences and of memories, the associated emotions were common to both personalities. Emotion is one of the most potent factors in producing disintegration; and so in this case an emotion of a depressing, anxious, or startling kind was one of the most common influences in producing instability and change of personality.

Per contra, we shall see when we come to study the neurasthenic state, and the methods by which the Real Miss Beauchamp was prevented from relapsing into her previous disintegrated states, that the induction of an exalting emotion was the most powerful agent in maintaining a state of integration and of mental and bodily stability.

<sup>1</sup> Page 298.

The induction of joy, of the emotion of well-being, of the excitement that goes with present pleasure and expectation of happiness produced a stability that resisted in a remarkable degree the disintegrating influences of a depressing environment. No better illustration could be had of the psychological law: "States of Pleasure are concomitant with an increase and states of Pain with an abatement of some or all of the vital functions."<sup>1</sup>

The striking difference between the psychology of emotions and that of ideas is worth noting. B IV and B I had amnesia for practically all the ideas and sensory experiences of each other, but the emotions awakened by such ideas and experiences were often retained, and were more or less common to both.

A perusal of the extensive records which were kept would make clear the peculiar instability of the disintegrated personality, the constant conflicts which in consequence were going on, and the difficulties offered in the management of the case.

<sup>1</sup> Bain's Mental Science

## CHAPTER XX

### DREAMS. B I AND B IV BECOME THE SAME PERSON WHEN ASLEEP

NOT the least interesting of the many psychological phenomena of this case were the dreams. The case is unique in one respect. Ordinarily, our knowledge of the contents of our dreams and of their relation to our environment is limited to our ability to recollect them upon awaking, and to inferences as to their origin, duration, etc. But in the case of Miss Beauchamp, one of the family (Sally), according to her own statement, was awake a large part of the night, while the main personality was sleeping, and therefore<sup>1</sup> conscious of the dreams that went on, just as she was conscious of Miss Beauchamp's thoughts during the day. She therefore knew when a dream began and when it ended, knew it in its entirety and often was able to connect it with its origin, external or internal.

The accounts which Sally has given me of the dream life of Miss Beauchamp contain, I think, some facts of value as well as of interest. They corroborate the theory that long and elaborate dreams may occupy a long or a short time between their beginning and ending. If what is true of Miss Beauchamp is true of the rest of us, what we remember as our dreams is but a small fraction of our psychological activity when asleep.

"I don't exactly understand what you mean by dreams," said Sally. "Miss Beauchamp's mind is 'going,' off and

<sup>1</sup> Sally insists upon this as a fact, claiming indeed never to sleep; at any rate Sally remembered dreams and other nocturnal experiences of which the primary personality had no recollection whatsoever.



on, all night long. She imagines then all sorts of things. Some of the things that she thinks [that is, dreams] she remembers when she wakes up, and some she doesn't. If she remembers them, you call them dreams, and the others you don't. I don't see why all the other things she thinks are not just as much dreams as what she remembers."

As to the amount of psychological activity that goes on during sleep, Sally made a statement which is of some interest from a psycho-physiological point of view. How far the evidence of her testimony, admitting that she correctly describes Miss Beauchamp's consciousness, is applicable to normal people is a question needing further investigation. It is probable that Miss Beauchamp's sleeping consciousness exhibits a very great exaggeration of what goes on in the minds of ordinary people during sleep; but even so, this very exaggeration, if corroborated by other observations, serves to bring out into relief the nature of dream processes and to show their relation to the personal consciousness. I am afraid it will be difficult to make Sally's statement intelligible without entering in great detail into the question of secondary subconscious states and thus anticipating what has been reserved as a problem for investigation in Part III. By secondary subconscious states, I mean not Sally's consciousness but those subconscious states which are supposed to form a part of the conscious experiences of normal people, — the true secondary consciousness. These include the sensory experiences which at one moment we are conscious of, and one moment not; which at one moment are synthesized with the personal consciousness, and one moment are left out of the synthesis, but which though left out still persist as secondary perceptions. The extent to which such conscious perceptions are present in normal people I pass by entirely for the present, until we shall be able to discuss the whole subject with all the data in hand.

In order to explain dreams Sally took up this subject of secondary conscious states as follows, without, I have every reason to believe, having previously had any knowledge of psychological doctrines:

"When you are writing out anything, when you are writing as you are now, for example [taking notes], you seem to think that the only thing you see is the thing you are writing. Well, it is n't so. You see and you know a great many more things. You see things out here and out there [referring to peripheral vision], and you hear the music which is now being played in the street, and you feel lots of things—the wind blowing through the windows, and the sounds in the house, and all sorts of things like that. Now while you are thinking of what you are writing these things go through your mind as images or sort of impressions. Some of them are not quite clear, but they are all there. They are not connected thoughts, but each makes its own image or impression, or sensation as the case may be. They are disconnected from one another. All this is going on all the time."<sup>1</sup>

Now these images or impressions, of which Miss B is not conscious, make up what Sally calls a second consciousness, which she has always called CII. (This is the CII to which Sally refers in her autobiography.<sup>2</sup>) It should be here stated that I made numerous experimental observations on the existence of such secondary conscious states in the Real Miss Beauchamp, and the results corroborated this statement so far as it goes.

Sally, after further elaborating the above statement with many details of the content of this secondary subconsciousness, made use of it to explain dreams. According to her observations, dreams are for the most part made up of ideas

<sup>1</sup> In writing Sally's explanation I supplied the technical words, but always after she had assented to their use as expressing her meaning.

<sup>2</sup> Page 371.

belonging to this secondary consciousness, although memorial images from any past conscious experiences may by association be woven into them. What is going on in the daytime is going on all the time during sleep at night. "It never stops the whole night long. The sounds from outside, the touch of the bed-clothes, the draughts of air, make sensory images or impressions in the same way as in the daytime." These weave themselves into dreams, but they also recall memories of what she has seen and heard and read, in fact, everything that she has ever been conscious of, so that in this way they arouse connected dreams. *When she is asleep, she hears every sound just as when she is awake and is listening.*<sup>1</sup> That is, the secondary consciousness hears. It feels the bed-clothes. The sensations sometimes give her horrible dreams. For instance, they sometimes make her feel as if she were smothering,

<sup>1</sup> This would explain the recognition and differentiation by a sleeping person of sounds, as the recognition by a mother of the cry of her child, or by a wife of the sounds of her husband's footsteps. The so-called premonitions through dreams would in some instances at least find an explanation in these facts. If the secondary consciousness has knowledge not possessed by the primary self, and if dreaming is done mainly by the secondary consciousness, then plainly a dream would convey information which would seem supernatural to the primary self. Suppose the second consciousness overheard a remark, or read in the newspapers by *peripheral* vision the news of some one's illness which was unknown to the primary self, then this fact coming out in a dream would seem miraculous. Indeed, Sally positively asserts that sometimes the images of words in the newspaper, for example, are seen by Miss Beauchamp *out of the corners of her eyes* while she is reading with central vision, and afterwards these peripheral images, of which she personally is not conscious, may come out in dreams. The peripheral vision, however, is limited and consists of a mere image of the printed words without any "meaning" (associated ideas?) being attached to it. Later the meaning becomes attached. By this, perhaps, is meant that in dreams the symbol recalls the ideas which are symbolized by the word. For herself, too, Sally claims, that while B I is concentrating her mind on central vision, she, Sally, need not pay attention to that, but can concentrate her own mind on peripheral vision and recognize things in the periphery. In test observations Sally has frequently described to me objects seen out of the corners of the eyes (peripheral vision), although B I or B IV was entirely oblivious of having seen them.

and then that brings up things she has read, that is, bits of different things.

Some of these ideas she remembers after waking, and then calls them dreams. (Hence it is that Sally thinks it most illogical "to call dreaming only what one remembers, because the same thing is going on all the time. If you call one thing dreams why should n't you call the other dreams?" To Sally, who remembered the whole dream, remembering a part of it was an inconsequential fact.)

Sally's statement, that she never slept, was difficult to prove or disprove, though the fact is unlikely, and it is probable that she is unaware of the lapse of time during which she sleeps. The conditions did not permit nocturnal observation, but there can be no doubt Sally herself believed her claim. More important is the question whether Sally is awake at all while the principal personalities slept. There is reason to believe that she was, or that some part of her was, a portion of the time at least. An analogous phenomenon which I personally observed has a bearing on the question: it was the persistence of Sally while B IV was so deeply etherized that she was unable to speak or move and was apparently unconscious. A good large quantity of ether was used. During this stage of etherization Sally gave prearranged signals, and afterwards *remembered* some nursery rhymes which I recited to her as a test of consciousness, it having been previously agreed that she was to repeat after coming out of the ether what I had said (see reference to "Hickory, dickory, dock," etc., in letter, Appendix O). On carrying the etherization still deeper the signals ceased. A possible fallacy in such experiments lies in the difficulty of distinguishing between unconsciousness from ether, and hypnotic sleep, the latter as the effect of suggestion.

The phenomenon of a dissociated consciousness, continuing in activity while the primary consciousness sleeps,

has been noted before. In the case of Anna Winsor, reported by Dr. Ira Barrows, it was observed that she was asleep while the secondary consciousness, nicknamed "Old Stump," was awake and performed many of its most striking feats. "Old Stump" was believed never to sleep. During sleep the hand, taken possession of by this dissociated state, not only wrote but conversed by signs, watched over the sleeper, summoned the nurse by rapping on the bedstead, and showed every sign of independent wakefulness.

If it were safe to generalize from the evidence of Sally in a particular instance like this, which, of course, is not the case, we should have to conclude that our minds must be in more or less constant activity during sleep; and that we are ignorant of the fact because for the greater part of the ideation there is amnesia on awaking. We recollect but a small part as our dreams. In this respect, the conditions are comparable to what occurs during and after hypnosis, trances, somnambulistic states, etc. Though those states are characterized by continuous mental activity, we fail to remember our thoughts afterward. It is improbable that in a normal person the ideation during sleep is as extensive as is the case with Miss Beauchamp, and hysterics generally; but it is quite likely that the flora of our dreams is much richer than we have any idea of.

Sally's statement regarding the time of origin and persistence of some dreams corroborates a generally accepted theory of psychology, namely, that very long dreams may occur at the moment only of waking up, and yet seem to the dreamer to have occurred during sleep. But, according to this testimony, it is not solely at such moments that these dreams occur: B I and B IV, according to Sally, had two different kinds of dreams; those that occurred during sleep, and those that occurred only at the moment of waking up, and either might be very long or short in content.

First, of the dreams occurring *during* sleep, some, though very long in content, might occupy a very brief moment of time. She had, indeed, known very long dreams to occur even while the clock was striking.<sup>1</sup> On the contrary, a dream very short in content might occupy a long period of time.

Second, at the moment of waking up, a very long dream might occur, which might give the impression to Miss Beauchamp that she had had a dream during sleep.

It sometimes happens that Miss Beauchamp wakes up frequently during the night, and at each moment of waking has a long dream which is continuous in content with the dream that she had at the moment of waking from the previous period of sleep. These are apt to be nightmares. Miss Beauchamp erroneously classes these continuous but successive dreams with those which occur during the sleeping period.

As to the origin of dreams, one curious and interesting statement which Sally makes is that Miss Beauchamp sometimes has dreams about what Sally is thinking of at the moment—Miss Beauchamp being, of course, asleep at the time—just as occasionally while awake Sally's thought comes into her mind. On such occasions Miss Beauchamp is surprised at having some irrelevant or incongruous thought thrust without apparent reason into her logical processes.

This interaction of the different consciousnesses is not surprising, but is what one would expect. The surprising thing is that this interaction occurs so rarely. The memory flashes coming from B I's mental life into that of B IV, or *vice versa* have already been discussed; this thrusting

<sup>1</sup> Note Sally's recognition of the clock's striking while Miss Beauchamp is dreaming. As Sally had no knowledge of time, the only way of measuring her time periods is by the time occupied by some event, such as the striking of the clock, or the act of waking up.

of Sally's thoughts into B I's consciousness (without previous "mind-fixing") is perhaps of the same order.

To return to the question whether Sally persists as a waking consciousness during the periods of Miss Beauchamp's sleep; it was difficult to prove or disprove this. There is no inherent impossibility in the claim. For after all, dreams are dissociated conscious states; they represent a persisting consciousness, persisting during the sleep of the remainder of the personal consciousness. Now dreams would differ from Sally's consciousness only in the greater organization or systematization of the latter's conscious states. If one group can persist in activity, there is no psychological impossibility in the other's enjoying a similar activity. In Sally's case perhaps the answer depends upon the extent of the field of subconsciousness which persists during sleep, and whether this field is sufficiently large to be entitled to be regarded as Sally. All the motor centres surely sleep, for Sally cannot move. Is what remains, if any, simply a limited group of subconscious states, or a personal self? This question must for the present remain unanswered.

However, wishing to have all the evidence that might be obtained from her own testimony, I got her at a later period to write out an account of her own thoughts and perceptions, and Miss Beauchamp's dreams, during several nights while Miss Beauchamp slept. They are curiously interesting, and warrant, I think, the records of two nights being given here. They are interpolated with a running fire of Sally's comments and philosophy and answers to B IV's criticisms. Sally used to write a paragraph or two at a time. Then B IV coming would read and comment aloud on Sally's production. Sally then would reply to the criticism, as appears in the text, interpolating her reply in the midst of her account. Each account is given just

as she wrote it. Those comments which form "asides" are printed between brackets in italics. C. (Christine) is used by Sally generally to designate a self which was a composite of B I and B IV, and which at this later period had been experimentally created. This C. had the memories of both I and IV. Sometimes, however, Sally speaks of B I as C. The distinction is not always clear, for when Sally spoke of Miss Beauchamp in connection with events prior to the hospital catastrophe of 1893 she always called her C. but she rarely gave the initial or name to B IV. In other words, C., in Sally's mind, was more intimately associated with the original Miss Beauchamp.

None of the other personalities had any remembrance of the events described by Sally as occurring while they slept.

*April 10th, 1902.* "Last night, B IV, after undressing and bathing, sat gazing into space for a long time. Then she got up and said, 'Good-night, Sally dear, you're another janitor,<sup>1</sup> I'm afraid,' and went to bed. Before she slept [B] I came. [B] I wondered what time it was — if she had seen you — if Mrs. Y.'s book had been returned — if I had been rude — if I had scrubbed her properly before getting into bed — why her photograph of Mrs. X. had disappeared, etc., etc., etc. It would take too long to write it all. She got up, saw that it was after eleven, but began bathing, nevertheless, and in the midst of it changed to [B] IV, who of course accused me at once of teasing her and went back to bed again, awfully cross. She fell asleep almost immediately this time and slept for hours. Part of the time she was very restless, — does that matter? — dreaming of London, running about there, you know. What you call dreaming, or at least what C. calls dreaming, is very curious. I don't see why you leave out so much if it's one thing, or why you put in so much if it's another. During this first sleep of C.'s there were students

<sup>1</sup> Jeanneton, a character in an old French book. This name, understood by Sally as janitor, hurt her feelings. "I am not a janitor," she protested. "A janitor is a person who makes the furnace fire and does that kind of thing."



going home, and trains and carriages passing, and once — this is really true — a man, walking very unsteadily, stopped beneath the window, and called, ‘Molly, Molly.’ No one answered for a minute, and he began to cry — *really* — and mumble. Then he turned to go back, but Molly had heard him and came running. She had clicky heels, and a horrid voice — not like his — and there was another man with her, following behind. Molly said, ‘O George, was n’t I good! I knew you way off there!’ Then George mumbled some more, and she kissed him terribly, and they all three went off together. C. did n’t wake up — would n’t wake up — though I wanted awfully to see them and tried to come.”

*April 10th, 1902.* [Letter to M. P.] “You must answer all my questions, please, no matter where you find them. B IV did call me another janitor, although she says now she did n’t, and pretends to be terribly amused over it. I think I ought to be amused instead of IV, for it was an extremely silly thing for her to say — utterly without meaning.”

*Another night:* “Last night B IV was very much disturbed over something, and kept walking up and down for a long time after she was all ready for bed. I did not know at the time what was troubling her, but I got it afterward, as you will see. The first time she stayed in bed only a few minutes, getting up then to take another sponge bath and tie her head up with hamamelis cloths. I came while she was doing this, but I did n’t finish it for her because it would n’t have been any use if I had; she always does things over after [B] I and me. I watched the people on the street instead, and wished I was out with them. It is so strange that other people are always much more interesting than C. Perhaps they are n’t if you come to really truly know them, as I know her. Because *they* think *she* is — [IV says I have omitted some things here, — that I hid the hamamelis bottle and tore her gown. I did n’t. I put the bottle in the drawer and covered it up so that it should n’t get spilled, and the gown tore itself when I was trying to curl up by the window] — awfully interesting. B I came while I was watching and meditating, and felt her head to see if it ached, and it did n’t! IV was only

pretending again.<sup>1</sup> [*IV says this is silly; that one does n't have to feel one's head to find whether it aches or not. I did n't mean just that. You see when C.<sup>2</sup> came I was sitting on her gown by the window, and the hamamelis cloths were tied on her arm so that they should n't get lost, and she thought at once that she must have had a headache, or some other sort of an ache, and she felt herself to see. And there was nothing, so she unfastened the bandages, put on her gown, and went to bed — as I wrote before.*] [B] I was tired though, and after praying, 'Keep him, dear God, for Christ's sake — always — and forgive me!' a very queer prayer, for it did n't begin or end as it should, and it is n't in the prayer-book, she kissed F. L.'s picture and went to bed.<sup>3</sup> But not to sleep. IV came again, scolding, 'O my head, my head! Sally, you're a little beast. Why can't you let things alone! O my head, my head! What in the world did you put that light out for? You knew I had n't finished. [*IV says you don't want any prayers in an account like this, and that if I think it absolutely necessary for C.'s reputation to put one in I'd better substitute one from the prayer-book. But C. did n't say one from the prayer-book. She said exactly what I have written, and it was a prayer, for it was said on her knees and in just the same way as at church. Of course if you don't want it in I can drop it easily enough. Some nights she says nicer ones, like other people.*] 'Where's the bottle? If I step on it I shall scream. You little, little beast!' Then she scrambled out, nursing her head (which did n't ache, you know), lighted the gas, sponged herself all over for the third time, tied the hamamelis cloths on, and went to bed. This time she slept, but very restlessly. I think she was not quiet more — [*IV says that I know nothing about whether her head ached or not, and that I've carefully omitted all mention of her long search for the bottle, and also of the difficulty her torn gown caused her. Well, perhaps I don't know, but at any rate when C.<sup>4</sup> herself came and*

<sup>1</sup> That is, IV had tied up her head to fool Sally.

<sup>2</sup> That is, B I.

<sup>3</sup> IV never says any prayers, prayer-book ones or any others. (Footnote by Sally.)

<sup>4</sup> The composite self, B I + B IV, above referred to, who had the memories of both B I and B IV.

remembered all about *IV* she remembered it that way, and I know *C*'s thoughts. And as for the bottle and her gown, I did n't mention them because I did n't consider them important enough. I can of course tell how *IV* turned everything upside down in the room in her search, and how she left things upside down for *C*. the next morning to put back. And I can tell too about how cross she got because in putting on her gown after her bath her arm got caught in the tear. She pulled it off furiously, threw it on the floor, and got into bed without it. I hope *IV* will find this quite clear now] — than a minute, and that in the very beginning, while she was asleep. There was a great deal of noise in the street, people passing, and carriages, with occasionally an automobile, but it was not that which made her restless. It was the memory of her conversation with *N*. in the afternoon. She dreamed that *N*. was a butterfly, she [*IV*] one wing — [*IV* says this is all nonsense — that there is n't a single thing to prove that the afternoon's conversation had disturbed her, and that the dream is probably pure invention. It is n't nonsense, and although it would take a lot of writing to prove what I have said, yet it can be done, and later shall be. As for the dream, what would be the use of my inventing things when her thoughts do it for me? Besides, whether *IV* remembers this dream or not, *C*. does, and would recognize it even in this cut-short form. All the dreams I may as well say are very briefly sketched in this account. It would take too long to write them out fully — as they really were — and I cannot see that it would be of any use] — a queer composite growth the other wing. She [*IV*, as the wing] was diseased, ought to be cut off — yet the cutting off would cripple *N*. So she struggled and kicked — literally — while it tried to fly, and the other wing kept changing in color and composition.

“She dreamed of being pursued by a huge cat, much larger than herself, which finally sprang upon her and tore open her breast. [*IV* says, ‘Interesting, if true,’ and it was interesting because you remember she had left her gown in a little heap on the floor, and the bandages had come off, and her hair was flying. And it is true, because I was there and not sleeping and knew all about it. I suppose she will be cross again now, but I can't help it. When she says some things like, ‘Really, Sally dear,

*how very interesting! How delightful! How sweet of you! — things that sound nice if you repeat them, but which you know are horrid — it makes me frantic.]*

“She dreamed of being lost in London — surrounded by a mob of the dreadful women there, who held her and forced her to listen to their vile talk.

“Then she dreamed of being dead, and in a coffin lined with hands which tried to clutch at her. Suddenly they all doubled up and seemed to be watching. C. wondered, but was so tired struggling to get away from them — [*IV says my notions of anatomy are mixed, or else my English is, and that what I have written gives the impression that the hands were watching. That is exactly the impression I want to give. They were watching, in C.'s dream. And IV knows that in dreams there are often much more curious things than that. I'm not making this up or writing for fun*] — that she leaned back, in her dream, on her brain, which was her pillow, to rest a minute. But the pillow moved — long freably worms wriggled out of it, covering her from head to foot, and she screamed with terror. When she tried to escape the worms, the hands clutched her. When she would avoid the hands, the worms went through and through her. Finally she awoke as C., whole, shuddering and cold, though — [*'freably' is n't a word, IV says. That does n't matter, if I choose to use it. When I say that she screamed with terror I mean that she dreamed she did. She really only made funny little gasping noises that one could hardly hear. Sometimes she does scream, and that makes her wake up, terribly frightened*] — simply dripping with perspiration. For a long time she could not pull herself together, but when she did she remembered everything, just as if she had been properly hypnotized in the afternoon. That is, she remembered all she had done and said and thought as [B] I and IV; she did not remember anything about me because that is not possible. I am different, and all that I do concerns just me. [*IV says it is absurd for me to make such a statement as this — that the facts do not bear me out, and consequently it would be better to omit this part altogether; that I am only a face [phase], and a passing one. She added something more to this criticism yesterday, but as I don't understand what she means I'm going to ignore it.*

“ Dr. Prince says she means ‘phase’ of her disease. It is true that two or three times she has in some sneaky way gotten hold of things that I’ve done and said, but never very correctly, and [B] I never has done it at all. Sometime I’m going to write out all that I think about this. Because, even if she were able to get a great deal, and get it exactly true, it would n’t follow that I am a part of her. Why, I get things belonging to [B] I and IV when both are dead, that is, things they know, like algebra; of course I know everything they do. It is hard, and I don’t like to do it much, for it makes me all squeezed. Dr. Hodgson said I could n’t do it, so I did it. As I am always alive, it ought to be loads easier for IV to get things from me. But she must get them in the same way that she would from J. or S. or X, Y, Z, and I think I know how to do that, although it will be very hard to tell how.] It was through her [C.] remembering when she awoke that I learned what had been troubling B IV in the evening, and why she was restless and pretended things. It was because she does n’t want to be a woman, because women are selfish and lay too much emphasis upon small things, and keep men from accomplishing their work in life— [This is weak all through, IV says. She thinks that as I did not know at the time what was troubling her and as I have said that I did not, all this rigmarole (I don’t know how to spell it, but that is what she said) should be excluded. She says her [C.’s] memory has been shown to be inaccurate repeatedly. Of course if she insists upon it, this can be cut out. I did not know at the time what was troubling her, and C.’s put-together-memory has been rather jumbly sometimes, but not lately; that is, she [C.] could not reconcile the memories and feelings of [B] I and IV. They were contradictory. Lately it has been all right for [B] I, and I think if IV were to stick to the truth, as she tells me to do, she would confess that it was her conscience and not her head that gave her so much pain that night. IV really misses the record I used to keep of her sins.] And because she had helped X, for whom she did not care, and could not help Y, whom she loved very much. And because Z was selfish, and inconsiderate, and exacting, making life very hard for Y. And because she could never be cured, . . . [IV says that X, Y, Z are delightfully mysterious, and that she wonders how I came to know them. They are n’t mysterious

*the least bit. Of course, you know, those aren't their real names. I just put them that way to make it more interesting, and because you must n't ever give names when you say things about people — it isn't a nice thing to do — but if IV really truly wants to know who they are, I'll tell her.]* It was twenty minutes after two when C. looked at her watch, but for all this part of the night I have chosen to record as dreams only those thoughts which hung together. The others, as far as I can make out, are not considered dreams. I do not know what you do call them. When I write my willing book I will try to find some name for them. [*IV says to please be exact here, and state just how many trains of thought, sets of dreams, etc., were going on at once. That is n't necessary ; it is all going into my willing book. Besides, there are n't 'sets' of dreams, and 'trains' of thought, at night, for 'sets' means two or three, and 'train' means together, and the night is n't like that if C. is sleeping — of course if she is awake it is different.*]

“As for myself, during this time I thought of heaps of things, but none of them were dream thoughts, for I never had a dream. Sometimes, when Dr. Prince makes me keep my eyes shut, and says that I can't open them, it makes me feel very queer, for I know I can, only that he is willing harder. [*IV says this is very i-n-t-e-r-e-s-t-i-n-g about Dr. Prince, but I've crossed it all out for the present. I don't wish to talk about it, because when you tell things some people always remember them — and then they make you do things so that you wish you had n't told, but you never can go back again to the time when they did n't know. I learned this myself since I got my eyes opened. Of course there are some who forget, and telling them about things does n't matter, but Dr. Prince is n't like that.*] As when people tell you to do things you do not wish to do you look . . . (Unfinished.)

“I thought mostly of the things I would like to do if I could. When some men who were quarrelling passed, I thought of them for a long while, and envied them, for it was very late — [*This would be much more interesting, IV says, if I would write out my thoughts, as I have attempted to write hers, and state whether it was the idea of a scrimmage which filled me with envy. No, it was n't. I do not like scrimmages. But I envied the men their freedom, and their clothes, and their ability to do as they wished*

*That was all. As for my thoughts . . . (Unfinished)*] — and they had the street to themselves. And when C. was dreaming about the coffin I wondered if there could be, as Dr. H. said, some part, some corner of her mind which I did not know about, for the dream had in it something of what I had thought and remembered while X was explaining about the Egyptian mummy images in the afternoon. It is very curious, and two or three times before I have been troubled by it. C. got up then and read until about four o'clock, because she was almost afraid to go to sleep again, but she did go, and slept until after six. She *dreamed* a great deal, but her dreaming was of a different kind — not distressing. She *dreamed* of being at Sorrento with J., and of living there day after day, waiting for some one, and the some one proved to be —, who had been exiled for some reason, and had come there to live because he loved J. and her. And she *dreamed* of living at home, and of watching for the sunrise on her knees in the empty room there — as she used to do — but not wearily, exultantly." . . . [For Sally's accounts of other nights, see Appendix K.]

[Received April 24 from Sally.] "I must talk to you. Don't you want six nights written out now? Nice ones, with dreams and all? If C. is n't ill she can't stay in bed and neglect everything — *can* she? *I must talk to you*, but Friday will do. I'm out of bed now, and it's not so bad. C.'s really herself now — her old self — although she has things rather amazingly twisted. Perhaps they'll come straight later. Don't make me help her, please. I'm not sure she's any better than [B] I."

The main point of interest at present about these dreams is whether they throw any light on the problem of multiple personality, and, more particularly, on the question of the relations of B I and B IV to the real self.

Now B I and B IV, of course, used to sleep, and to sleep meant, as Hamlet said, to dream. Did each have her own individual dream, of which the other had no memory, or were all dreams common to both? In the

former case it meant that the division of consciousness and corresponding cerebral disintegration persisted during sleep; in the latter case, that during sleep the two personalities reverted to a common consciousness. These latter findings, too, would be in harmony with the hypothesis that neither B I nor B IV was the real self.

On the other hand, if there was only one set of dreams and that was remembered by only one personality, say B IV, the implication would be that this personality was approximately the real self, and that the other was only a somnambulistic condition.

Now, as a matter of fact, as a result of the inquiry into dreams, it transpired that however distinct and separate was the ideation of B I and B IV during the waking state, during sleep these personalities reverted to a common consciousness and became one and the same. That is to say, the dreams were common to both: each, B I and B IV, had the same dreams, and each remembered them afterward as her own. The logical consequence of this was that the dreams might have their origin in the waking experiences of either B I or B IV. If in those of B I, then B IV on waking, though remembering the dream, would have no idea of its source; and *vice versa*. For instance, the dream might be of a person seen in the street by B I, B IV would then fail to recognize the origin of the dream person, though B I would do so.

The fact that Sally knows B IV's dreams also indicates that B I and B IV revert to a common consciousness, which is probably the real self asleep. Of course, all Sally knows is that B IV, of whose thoughts she is ignorant, falls asleep and then begins to dream; when she begins to dream, she (Sally) knows her thoughts.

The dreams of B I and B IV are also those of B II. Ask B II what her dream of last night was, and you will find that it is the same in every particular as that of B I



and B IV. So that all these personalities become one, so far as their thoughts are concerned, when they are asleep. It is when they wake that they become differentiated. This all harmonizes with the hypothesis that B II may be the real self hypnotized. And yet the experiment of waking B II had been a failure.

## CHAPTER XXI

### THE PSYCHOLOGY OF SUDDEN CONVERSION: MISS BEAUCHAMP FALLS INTO A STATE OF ECSTASY AND BELIEVES HERSELF CURED

ON February 16, 1900, the following ecstatic letter was received from poor Miss Beauchamp, telling of the great joy that had come into her life because, as she believed, she was cured at last:

"I want you," the letter ran, "to be the very first to hear my glad tidings of peace and joy. They have come to me at last, after all these years of unrest and suffering, come despite my impatience and unbelief, despite my little faith, my much sinning. Are'n't you glad for me? — very, very glad? But I know that you are. You have been so good, so patient always. I cannot thank you. Words are all too poor for that, even though they would come at my bidding, but I shall never, never forget you nor what you have done for me. And if I have made things very hard for you, especially during this last year, I beg that you will forgive me now."

I had been prepared for this announcement by an interview the previous afternoon with Sally, who, in a state of discontent, had come to air her woes. The family, Sally said, was kicking up didoes, and she was n't going to stand it, and that was all there was to it. B I thought herself cured and was trying to get into a convent; B IV had taken half the contents of a two-ounce bottle of laudanum, but it had made her sick and she had vomited, which was perhaps what saved her life. Sally did not understand the meaning of it because not only did she not know B IV's thoughts, but "IV was not that kind of a

person." As to B I's going into a convent, Sally was disgusted at the idea; it was perfectly absurd, she insisted, for Miss Beauchamp was not fitted for it; nevertheless Miss Beauchamp was making her preparations, and was trying to bring the matter about. Evidently, underlying Sally's views of fitness was the fear that possibly she herself might be shut up in a convent, a life not to her liking.

Here was a new tangle into which the family was getting and which required to be straightened out. So I despatched a letter to each of the senior members separately, asking for an interview.<sup>1</sup>

B I arrived in a state of mind different from any in which she had ever appeared. She was in a high state of mental exhilaration, because, as she averred, she was cured at last. All her symptoms had vanished, and she experienced a feeling of well-being and physical health. She believed herself well. No letters had been received of late from Sally, and from this she inferred that that lady had disappeared for good. (She did not know that, for a wonder, Sally had kept her promise not to write such letters.) To be sure, she had slight relapses when she "lost time," as she admitted. But these periods were of short duration, and she did not consider them of importance. She plainly interpreted every event through her dominant idea of physical, if not spiritual, "conversion." She thought she was more like her old self, as she had been before this trouble came upon her, and was supremely happy. She was also highly excited over the scheme of joining the Catholic Church, and going into a convent. The recovery of her health would allow her to follow a religious life in accordance with her ideals. Besides the religious satisfaction which a convent promised, it would solve the problem of the practical difficulties of her present life. She argued, very logically, that she was not fit to

<sup>1</sup> Sally arranged that each should get her own letter.

take care of herself. She might, under the strains of life, have new attacks of her trouble, and here, at last, was a haven of rest, a life serene and congenial to her ideals and tastes. She was plainly in a state of exaltation. Although she had not slept for more than an hour a night for several nights, nevertheless she was not a bit tired, although under ordinary circumstances she would have been a physical wreck.

Her happiness would have been delightful to look upon, had it not been that it was an abnormal condition, and one that could not last. Psychologically, this new mental condition was interesting, as it afforded an opportunity to observe an example of that state of exaltation into which notoriously so many religious enthusiasts have fallen when the feeling of a new spiritual life has been awakened in them. At such moments, under the influence of a dominating idea which has surged up perhaps from somewhere within them, or has been suggested by their own conscious thoughts, they have been filled with a strong emotion of joyousness, and have interpreted their relations to their environment, to the world, and to God, in accordance with this imperative idea, often to the extent of creating hallucinations and illusions which to them appear as supernatural communications.

Inquiry into the origin of Miss Beauchamp's belief proved an interesting study, throwing light as it did upon the psychological mechanism of those sudden miraculous conversions which have played so important a part in religious history. An account of how Miss Beauchamp's ecstatic belief was brought about was obtained from B I a and B II.

B I a, who, it will be remembered, is simply Miss Beauchamp hypnotized, stated that B I in a condition of hopeless despair had betaken herself to church, thinking that through self-communing and prayer she might find some

way out of her difficulties. What particularly distressed B I was her transformation into Sally, who seemed to be absorbing more and more of her life, and the feeling that sooner or later she herself would become too great a tax upon the patience and care of her friends. What, she asked herself, would become of her when thrown upon her own resources. The church was empty, and, as she communed with herself, her feeling of self-despair and hopelessness deepened. *Then, of a sudden, all was changed, without her knowing how or why.* She became filled with a great emotion of joyousness and of well-being; a "great load seemed to be lifted from her;" she felt "as light as air." A great feeling of peace, of restfulness, and happiness came over her. She felt well and believed herself well. With these emotions came religious memories, memories of her own experiences and of religious visions which she had had a long time ago. She remembered, for instance, visions of the Madonna and of Christ and scenes of a religious character (Appendix L). Her cure seemed miraculous, and she felt and believed that she had had a Visitation. Under the influence of these exalted religious feelings the idea naturally came to her of entering a convent. The life appealed to her and she thought that the freedom from care and anxiety which it offered would solve the problem of her own life, and that she would remain well. This was all the light that B I a could throw upon the change in Miss Beauchamp's condition. She was able to state the facts, but was unable to explain by what psychological process the transformation had been suddenly made from the state of hopeless depression to that of religious exaltation and happiness. The complete explanation was obtained from B II.

*There was a gap in B Ia's knowledge, that is, between the ending of the depressed state and the inrushing of the exalted state. This gap B II was able to fill. (This*

hypnotic personality clearly recognized Miss Beauchamp's condition as purely one of ecstasy, indeed so clearly that she analyzed her mental condition for me. The point is worth noting that Miss Beauchamp hypnotized into B II became a perfectly rational person who recognized the previous quasi-delirium of herself.) B II's account of the origin of Miss Beauchamp's ecstasy was very precise and as follows:

While Miss Beauchamp was communing with herself, her eyes became fixed upon one of the shining brass lamps in the church. She went into an hypnotic, or trance-like state, of which neither Miss Beauchamp nor B I a has any memory. In this hypnotic state her consciousness was made up of a great many disconnected memories, each memory being accompanied by emotion. There were memories of religious experiences connected with her own life and other memories of a religious character; and these memories were accompanied by the emotions which they had originally evoked. There were also memories of her early life, memories of happy times when she had been well; these memories also were associated with the emotions which she had at the time experienced. For instance, to take a few specific illustrations and tabulate them with the accompanying emotion:

MEMORY	EMOTION
of a scene at —, a view of the sea with the light of the setting sun playing upon the water.	of well being; peacefulness, and happiness.
of walking with a friend near the same place and conversing.	of peacefulness and rest.
of driving in the country with same friend.	of peacefulness and rest.

[The above were all real incidents of her girlhood.]

of different visions of Christ and the saints. [All or most of these she had had at different times in the past.]	of exaltation, of lightness of body, of mental relief, peacefulness, and joyousness.
---	--

of a vision of herself shut up in a dungeon.	of restfulness, happiness, lightness of body.
--	---

of music which she had heard in a church.	[Not the usual emotional thrills of music, but] of lightness of body and great joy.
---	---

There was no logical connection between these memories — all were jumbled and without order, but the accompanying emotions were very strong.

After a short time Miss Beauchamp awoke, and on waking all the memories which made up the consciousness of the hypnotic state were forgotten. At first her *mind was a blank so far as logical ideas were concerned*. She thought of nothing definite, though soon ideas rapidly flitted through her mind, and yet she was filled with emotions. They were the *same emotions which belonged to the different memories of the hypnotic state. These emotions persisted*.<sup>1</sup> They were of lightness of body,<sup>2</sup> of physical restfulness, and well-being, besides those of exaltation, joyousness, and peace, largely of a religious nature. It is probable, reasoning from analogous phenomena that I

<sup>1</sup> We have already seen examples of this persistence of the emotion belonging to a dissociated state after the subject has changed to another state. That is, the emotions of B IV were often felt by B I, and vice versa. When we come to study the subconscious state, or the secondary consciousness, we shall find that it is made up of disconnected memories and emotions, and that the latter may be common to both the primary and the secondary consciousness. I frequently made use of this principle for therapeutic purposes, that is, creating in B II emotions of well-being. When she awoke the same feelings persisted in the waking state though everything said and done during hypnosis was forgotten.

<sup>2</sup> Lightness of body may possibly be, strictly speaking, a sensation rather than an emotion, and yet it is probably a complex feeling, and so interwoven with emotion that it may for practical purposes be regarded as an emotion.

have witnessed, there were *subconsciously* present a number of disconnected images, or memories, — remnants of those which had been experienced in the trance state, and associated with the emotions (p. 298).<sup>1</sup> Presently ideas began to come into her mind. The emotions were now accompanied by a lot of ideas and memories of religious experiences, those which B I a had described. It is significant that these ideas were not those originally associated with the emotions in hypnosis, but newly suggested ideas. At least they appear to have been suggested by the emotions. She felt well and believed herself cured at last.

Naturally, as Miss Beauchamp did not know what occurred during the time-gap when she was in the trance-like state, she thought that the sudden change in her mental condition and physical health was miraculous and was due to a "Visitation." The idea of a convent life logically followed her religious exaltation.

Before discussing further the psychological mechanism of Miss Beauchamp's "ecstasy" I should like to point out the striking psychological similarity between her experience and that of M. Alphonse Ratisbonne, whose case William James quotes in a chapter on Conversion in his very interesting lectures on "The Varieties of Religious Experience." For several days Ratisbonne had been unable to banish from his mind the words of a prayer given him by a proselytizing friend, and the night before the crisis had had a sort of religious nightmare. Then after entering a church some kind of a psychical accident happened; all the surroundings vanished and the crisis came.<sup>2</sup>

It would seem clear from Ratisbonne's own account that he must have gone into a trance in the church at the moment when "the dog had disappeared, the whole church had vanished," and he "no longer saw anything"

<sup>1</sup> See Appendix R; also *Journal of Abnormal Psychology*, Vol. I, No. 1.

<sup>2</sup> See Appendix M.



about him, and that he had a religious vision accompanied by ecstatic emotions. At any rate, he went into a state which was abnormal, and presumably identical with the state into which Miss Beauchamp fell, except that it was followed by partial memory, that is, of the vision of the Virgin. I would say here, parenthetically, that any one who has had experience in catechising persons who are the subjects of psychoses must feel great scepticism about accepting their statements of their psychological experiences without subjecting them to a very critical examination. Such subjects generally describe their experiences under the dominating belief of their own interpretation. A searching cross-examination will generally bring out lacunæ in either their memories or statements, and numerous additional facts which put an entirely different interpretation upon the phenomena.

Thus Miss Beauchamp exhibited a hiatus in her memory and was unable to give a complete account of what happened in the church. To obtain such a complete history it was necessary to resort to hypnosis, and even the hypnotic state, B Ia, knew only a part of the mental facts. It was necessary to obtain a larger hypnotic state, B II, to obtain a complete memory of what had taken place in the subject's consciousness. Similarly the mere statements of people who have experienced "conversion" can scarcely be regarded as sufficient to determine the psychological processes involved. An examination under hypnosis in most cases probably would bring out all the details of the process. The mental condition of the subject in such supreme moments is summed up by James as follows:

"It is natural that those who personally have traversed such an experience should carry away a feeling of its being a miracle rather than a natural process. Voices are often heard, lights seen, or visions witnessed; automatic motor phenomena occur; and it always seems, after the surrender of the personal will, as

if an extraneous higher power had flooded in and taken possession. Moreover the sense of renovation, safety, cleanness, rightness, can be so marvellous and jubilant as well to warrant one's belief in a radically new substantial nature."<sup>1</sup>

James's theory explains "the phenomena as partly due to explicitly conscious processes of thought and will, but as due largely also to the subconscious incubation and maturing of motives deposited by the experiences of life. When ripe, the results hatch out, or burst into flower."<sup>2</sup>

According to this theory there is a gradual growth of ideas which have been dissociated at some previous time from the primary consciousness, and when these subconscious thoughts reach a certain development they burst into the field of the waking self. It is possible that this may be the mechanism of the processes in certain minds, particularly those of the hysterical type, in which a subconsciousness is readily formed, but the weak point in the theory is that no positive evidence has thus far been brought forward that there is such a large doubling of normal minds; and even in hysterical minds, though the theory may well be true, it still lacks, as does that of Sidis, experimental verification. I am inclined to think that when sufficient data have been collected to explain completely the psychological process, it will be found that, though the subconscious plays a part, James's theory needs considerable modification. It will be noticed in B I that the process resulting in the state of ecstasy was quite different. In her case there was no incubation or flowering of subconscious ideas; it was simply that the emotions of the trance state persisted after waking as a state of exaltation, and of themselves, through their naturally associated ideas, suggested the beliefs which took possession of her

<sup>1</sup> *The Varieties of Religious Experience*, p. 238.

<sup>2</sup> *Ibid.*, p. 230. Sidis ("Psychology of Suggestion") earlier expressed the view that the phenomena manifested in religious revivals are due to dissociation of consciousness and suggestions to the subconscious.

mind. So I think it will probably be found that the part played in other cases by the subconscious mind consists in furnishing emotions (which primarily belong to its disconnected memories), rather than logical ideas.

The fact that in times of sudden conversion voices are often heard, lights seen, visions witnessed, etc., together with an overpowering emotion, is evidence that these people at such moments are not in a stable state of mind, but rather, it would seem, in a trance-like or hypnoid condition, or whatever name we may choose to call it by. In this state a complete recognition of the surroundings may be lost, and the subject is dominated by hallucinatory ideas and emotions.

There is no difference fundamentally between such a state and certain so-called hysterical states which quite commonly are observed following emotional shocks. The emotional factor in producing the hysterical state is generally of a startling or terrorizing character, and hence this state is frequently observed as the onset of traumatic neuroses, which are most commonly caused by terrifying accidents like railway collisions. Or, the emotion may be simply part of an intense apprehension or idea of danger, or it may be simply the sequence of a startling piece of news, such as would shock the natural feelings of affection, or awaken intense jealousy, etc. Thus, Fanny S. was thrown into such a condition on hearing the news of an accident to a relative who had been hit by a passing railroad train, though the injury was not serious; and Mary H. went into a similar condition when it was announced to her that her husband had eloped with another woman. After waking there may be complete, partial, or no amnesia, but in any event the ideas belonging to the crisis with their emotions, like fear of fire, or of disease, or of danger of one form or another, may persist or recur subconsciously, and then from time to time enter the per-

sonal consciousness; or the personal consciousness may be continuously conscious of the emotions without being aware of their exact source or meaning. In the latter case, the sufferer may be the constant prey of depressing fears — true obsessions. In all such psychoses the emotional element causing the split in the normal integration of the mind is of a distressing character.

But it may be that effects psychologically similar may be produced by powerful ecstatic emotions which the religious imagination calls forth. The development of such exalting emotions becomes easier when preceded by the mental strain ordinarily induced by the doubts, fears, and anxieties, which go with the intense introspection which religious scruples call forth. Torn and distracted by doubt, the personality is easily disintegrated, and then the ecstatic emotions associated with religious hopes and longings take root. At this crucial moment the subject, like St. Paul when he heard the voice of Christ, perhaps half oblivious of his surroundings, sees visions which are apt to be the expression of his new belief, and hears a voice which speaks his own previous thoughts. On coming out of this hysteroid, or hypnoid, state the exalting emotions persist, along with an incomplete, or possibly complete, memory of all that took place in the hysteroid state. These emotions then give an entirely new shape and trend to the individual ideas, just as the distressing emotions following hysterical accidents determine the form of the mental content. Psychologically, the ecstatic state following is as much an obsession as is one in which fixed depressive fears are dominant. I think that it will be found that in sudden conversions of the type we are considering, this is substantially the psychology of the matter, and that the succeeding mental state of ecstasy is conditional on the development of a hysterical state at the onset, as it plainly was in the case of Ratisbonne.

The analysis of a large number of cases made *at the time of the crisis* is essential for a proper study and understanding of the phenomenon. The memory of a person who narrates his experience afterwards is unreliable, as he notoriously may be the victim of amnesia, and it is unsafe to trust statements purporting to give the psychical state of the subject at a moment when he was under intense emotional excitement. If it was the fact that he went into a trance state, he probably, like B I, would be unaware of it. Such personal accounts, too, are always written from a religious and not from a psychological point of view. It is to be hoped that at some time in the future a psychologist may have the opportunity to examine critically a number of such cases at first hand, and particularly by the hypnotic method. It is probable that this method will bring out facts now scarcely suspected.

## CHAPTER XXII

### SALLY PLAYS MEDIUM (SUBCONSCIOUS WRITING)

**A**FTER solving the problem of B I's ecstasy, I brought Sally, who was in high spirits, notwithstanding the fact, which she admitted, that she was herself disappearing, going back to whence she came. She was being locked up again in the subterranean vaults of the consciousness of Miss Beauchamp, and was "deader now than any one of the family." She did n't like it, and she did n't want to go into a convent, and she "was n't going to, either." Then Sally became very naughty, and said a lot of impertinent things, largely as an outlet of jealousy, putting a childlike construction on various things she had heard. But the fit did not last long, for that evening she wrote a repentant letter, of which the following is an abstract. I wish I could give the letter in its entirety, as it shows the sweet side of her character, but it would not be fair to her.

"I am so sorry," she wrote. "I was perfectly horrid this afternoon, but now I am all repentant and I want to listen." Then she goes on to describe her own point of view. "I cannot bear," the letter continued, "to think of going off under Papa Leo's wing, never seeing anybody again. . . . I can't do it, Dr. Prince, I can't and I won't, . . . I don't want any nasty old priestly man. I hate them all! Are n't you the least bit sorry for me? . . . Because I have behaved badly to you I am going to take B I to the cathedral thing to divert her mind. You like that, don't you? . . . Do poodles have morals too? Is n't there *any* place free from them? I don't want

them, nor anything but . . . and I can't see why it should be wrong . . . but, right or wrong, I don't care. Please forgive me again . . . and let me *stay*. *Please, please, please.*"

The following letters from IV and Sally illustrate the way in which one got into hot water in consequence of an inconvenient change at the wrong moment. Sally, owing to her childish ignorance of worldly wisdom, had misinterpreted the meaning of something said by "Jones," and had quoted him accordingly. When afterward Sally told "Jones" how she had quoted him he naturally was annoyed, and charged her with a message correcting his reported statement; but just as he was delivering himself Sally changed to IV and got the message, which was entirely unintelligible to her and not flattering to her vanity, as it referred to her worldly ignorance as Sally. (It is, naturally, impossible for either B I or IV completely to realize her character as it is portrayed by her subconsciousness.) IV's letter runs as follows:

"Thanks for your note, which I hoped to acknowledge personally on Friday, but could not because of an urgent summons elsewhere—to Mars or Saturn, I think, from which I have but just returned. You do not consider laudanum experiments interesting? Neither do I *now*. But they might have been, you know, and at any rate I am loads wiser than before. Which reminds me that one thing I am particularly charged to say to you had better be said now. It is in connection with my wisdom—or rather lack of it—through which it seems I have been misrepresenting J. He regrets exceedingly that it is not possible for him to appear personally in the matter, but wants you to know that he never made, nor dreamed of making, any such statements as I credited him with. He also says further that he is sure you will agree with him in absolving me from all evil intent, as it arose from my 'almost incredible ignorance concerning certain things, an ignorance which by this time you must be quite as conscious of as he is.' Delightfully

flattering, is n't it? But I promised you should have the message as he gave it.

"I have not accomplished anything this morning, nor have I finished the accounts you asked me to write out. I know what you will say — that I have not really tried — but it is not true, and you, wonder-worker, should know that it is n't. I *have* tried and I shall keep on trying to the end; if not with you, then with some one else. Yet I hope with you.

"I shall come Wednesday, unless you write me to the contrary. If you do, please drop the IV. It is so absurd.

"Monday.

"Don't you think the odds are tremendously against me in this attempt to conquer Sally?"

Here is Sally's letter of February 20, 1900, on the same subject. These letters bring out the contrast between the two personalities:

"I must write this in the greatest haste, but I want you to know that I did n't tell her anything — *really*. She got the message because J. was so anxious to be quoted correctly that he repeated it again after she came. I'm so sorry! I can't seem to keep out of hot water with any one except Dicky. . . . He wants me to write him now, and IV is simply raging about it. She will probably tell you when you see her, unless she is in one of her proud fits. I cannot understand her. She is the most puzzling, contradictory creature I ever saw. I want to tell you about J. tomorrow, and about Dicky's letters and experiments. You are dear to pardon all my offences, but I knew you would. B I is still in the clouds, and still fancies herself cured. She's doing all sorts of things so that IV and myself are awfully squeezed. We don't have any time, nor amusement, nor anything that we want, but IV keeps on fighting just the same. She simply won't give in. It is amusing, and sometimes I rather like her. She snubs D—— most unmercifully when he tries to assume a protecting air. He is n't so scientific now."



Only a few days passed before there was more trouble. Sally had not only appropriated again most of IV's money, but had spent it and put the latter on a short allowance of a few cents a day; in addition to this IV had discovered that Sally had accepted a present of money from some acquaintance, presumably Anna. IV was much annoyed in consequence of the false position in which she was placed. Unwilling that Sally, much more herself, should accept a gift from this source, IV insisted that the money should be paid back. I pass by all this and the troubles it led to, as well as what appeared to be a surreptitious attempt on the part of Anna to induce Sally to secure possession of the "Autobiography."

I was, of course, called in to bring Sally to account and to rectify affairs. In desperation, IV had prepared an ultimatum,<sup>1</sup> which, if Sally and Sally's friends did not accept, she proposed to put into effect. It provided that all communication between Sally and her friends, Anna and Jones, was to cease, there were to be "no more nonsense letters, no more appeals to me, no interference with her mail, with money, with papers, with clothes." Sally was to have a fixed allowance of money each week, a certain stated time to herself for certain purposes, and she was to finish the autobiography immediately. Full authority was given to myself and one other person to take action in IV's affairs if Anna and Jones did not give up all communication with Sally; and if Sally on her part persisted in going on in the way she was doing, she, Sally (which, of course, included the family) was to be locked up in an asylum. It mattered not that IV would necessarily be locked up too. She was in earnest now, her blood was up. Whatever the consequences to herself, Sally must be controlled.

<sup>1</sup> I have a rough draft of this ultimatum in my possession.

The following was received from Sally the day after IV disclosed her woes and wrote her ultimatum:

"Are you going to send *me* away too and never, never let me see you again? I have n't been bad enough for that, have I? really and truly bad? wicked? I did not mean to be. I can't bear to have you cross with me! I can't! It's worse than everything else. Oh, so much worse. B I is good, is n't she?

"Will you talk to her? . . . I'm sending you what IV has been scribbling, because it's psychological and I thought you'd like it. Please say you are glad. I want you to be always glad. Some day you will be old, won't you? very, very old I mean, and not be able to do things — the things that you wish for now. And tell me, will it be soon or on some far, far day? I want to know.

"Sincerely and entirely,

"Your repentant,

"S. B.

"Friday."

A day or two later IV had what must be accounted a very remarkable experience in what the ancients would have called demoniac possession, and which to-day we are familiar with in minor forms as subconscious mental action. I am certain that in Biblical, and perhaps in early Salem days, when they hung witches, if a person exhibited the peculiar manifestations which I am going to relate she would have been considered to be literally possessed by the devil (I hope Sally will not take offence if her eyes ever rest on this), and perhaps would have been burned at the stake if the devil (or Sally) could not be otherwise cast out.

This is what happened, substantially in B IV's own words as I took them down:

B IV, in a depressed, despondent, rather angry frame of mind, was looking at herself in the mirror. She was combing her hair, and at the time thinking deeply over

the interview she had just had with me in regard to her ultimatum to Sally. Suddenly she saw, notwithstanding the seriousness of her thoughts, a curious, laughing expression — a regular diabolical smile — come over her face. It was not her own expression, but one that she had never seen before. It seemed to her devilish, diabolical, and uncanny, entirely out of keeping with her thoughts. (This expression I recognized from the description to be the peculiar smile of Sally, which I had often seen upon the face of B I or B IV.) IV had a feeling of horror come over her at what she saw. She seemed to recognize it as the expression of the thing that possessed her. She saw herself as another person in the mirror and was frightened by the extraordinary character of the expression. (Here she broke off her story to ask if it was possible to see oneself as another person in this way.) It suddenly occurred to her to talk to this “thing,” to this “other person,” in the mirror; to put questions to “it.” So she began, but she got no answer. Then she realized that the method was absurd, and that it was impossible for her to speak and answer at the same time. Thereupon she suggested to the “thing” that it should *write* answers to her questions. Accordingly, placing some paper before her on the bureau and taking a pencil in her hand, she addressed herself to the face in the glass. Presently her hand began to write, answering the questions that were asked, while B IV, excited, curious, wild for information of the past, kept up a running fire of comment on the answers of Sally, for, of course, the “thing” was Sally.

The following is a partial record of the questions and answers written out, with comments by B IV from the original, which I have:

First, questions, to which no answer is given; then speech setting forth Sally Beauchamp’s responsibility for the face [in the mirror] and threatening laudanum, etc.,

unless questions are answered immediately. Still no response — then pencil and paper.

(Who are you?)<sup>1</sup>

*A spirit.*

(Stuff! Tell the truth. Why did I forget?)

*Forget what?*

(From Providence. What happened then? What does it all mean?)

*Jones spoke to you and you died.*

(Answer me.)

*I have answered you. Ask Dr. Prince.*

(Why do you dislike Dr. Prince?)

*I don't. I like him. Amen.*

(Indeed! How very interesting! Shall I tell him? What about A— M—, then, and why have you been gossiping?)

*I won't tell you.*

(You will tell me.)

*I won't.*

(You will.) The pencil is pressed down so hard that it breaks; then it is flung violently across the room. I feel as if I were losing consciousness, but by a great effort I hold myself, take another pencil, and repeat:

(You will.)

I get nothing, however, for several minutes; then a lot of curving lines, then,

*What do you want to know?*

(What I said, what Dr. Prince said, what you said.)

*I won't tell you.*

( . . . . . )

Only a threat concerning J., which I had not the slightest intention of putting into force. It acted like magic on the "spirit," however, and I got the following, written very rapidly:

<sup>1</sup> The questions asked by B IV are enclosed in parentheses; the replies written by the hand are printed in italics.

[Here the "spirit" told the substance of the conversation between Sally and Jones, which afterwards was the occasion of the latter's reproving Sally and sending the message which IV got by mistake through an untimely change of personality.]

. . . *When I told Dr. Prince he said, "Nonsense, it is n't true, and you must have misunderstood Jones." And I asked Jones again and you got the message yourself.*

(When did you repeat this stuff?)

*Ten years ago last Monday.*

(Answer me.)

*I have answered you. Ask Dr. Prince.*

(Why have you dropped Jones and Anna?)

*You dropped them yourself.*

(Why do you hate me?)

The answer to this question was a rude sketch of a girl seated by an open fire. It was wholly without suggestion as far as I could see. I have received similar ones in the past.

(Have you been telling Dicky what I said about him? Don't you know any better?)

*No.*

(You have, too. Can you make me hear things?)

*Yes.*

(You can't. You shall help me to remember them. Don't write. Go back, back, way back to Providence and Jones, and make me remember everything, everything. Do you understand?)

*I won't do it. You shall not remember. Amen. Amen.*

Again I feel as if losing consciousness, and again I exert my will to the very utmost to prevent this. A great many things come into my mind as memories, not very clearly, however, and not in a sequence. I ask about A—M— as a sort of test and then is written —

*I won't. I won't. I won't.*

Another struggle (mental), then certain things come to me; whether they are true or not, I do not know. I get intensely excited, then I remember about the experiment connected with A— M—, which you had wished to try in the morning. If I can get that it will be more satisfactory, more convincing, for it can be verified. I repeat again certain phrases, mentally, to Sally, with this in view, but I get nothing. Then I repeat them, the phrases, aloud, and there come to me slowly, not very clearly, certain things — those which I wrote you — which you said were approximately correct. Then in writing I get:

*Devil, devil, devil. Amen. You'll be sorry when I'm gone. Amen. You don't care.* Then a lot of wild scrawling lines.

B IV, further commenting on this experience, writes:

“I was intensely excited, talked much more than was necessary, and could not help commenting on everything that was written. The writing was very poor, difficult to decipher, and spread all over the paper. The whole thing occupied about two hours, as nearly as I can judge.”

The fact that the writing was spontaneous, like that which I had an opportunity to personally observe and which will be given in the next chapter, deserves to be emphasized, because this spontaneity removes it from the class of artifacts unwittingly manufactured by the observer. B IV, as she testifies, was not in an abstracted state while the writing was done, but was alert, conscious of her surroundings, excited and extremely curious to know what the hand was writing. It is to be regretted that she was not under observation at the time, — though this would have given rise to the suspicion that the doubling of consciousness was an artifact, — but I have seen the same feat performed under substantially similar conditions.

*Under these conditions of alertness* the content of the writing indicates that the authorship was that of some sort of a self which at the moment was co-conscious and possessed of wide memories and of a peculiar individuality. Beginning with the smile in the glass, followed by the desire to tease, the evidences of dislike, and the knowledge exhibited on the part of Sally, we find, running throughout the episode, evidences of a very different kind of mentation in the subconscious self from that peculiar to the primary consciousness. But besides this difference in quality, the wide extent of the field of the subconsciousness, as revealed by her replies, is worth noting. A study of Sally's replies shows a knowledge of facts, which, from my personal familiarity with them, there is reason to believe were not known by IV. They belonged to Sally's life or to that of B I. The field of subconscious ideas would seem to rival in extent what she possesses when present as the dominant consciousness. There are also evidences of humor, logical reasoning, and volition.

Let us not forget, however, that when automatic phenomena are obtained while the subject is in a state of deep abstraction, as is probably most often the case, they will not, from my point of view, bear the interpretation that they are wholly the manifestation of a subconscious mind. Under such conditions much of this sort of automatism, whether in normal or abnormal persons, is only in *appearance* a subconscious manifestation. In reality it is in large part, if not wholly, due to *alternation* of conscious states. The state of abstraction into which the subject goes is so deep that there is little left of the principal consciousness. A new personality is formed and this personality is more of an alternating than a subconscious one. It does the writing while the original personality is reduced to a few automatic thoughts and actions, like reading aloud. The real automatism is that of the distracted, and often blind, deaf,

dumb, and anesthetic extract of the former self, while the second self is a quite awake person. From this point of view the following observation of Dr. Janet's belongs to this type:

"She [Mme. B.] was seated at a table and held in her left hand the piece of knitting at which she had been working, Her face was calm, *her eyes looked into space with a certain fixity*, but she was not cataleptic, for she was humming a rustic air; her right hand wrote quickly, and, as it were, surreptitiously. I removed the paper without her noticing me, and then spoke to her; she turned round wide-awake, but *surprised to see me, for in her state of distraction she had not noticed my approach. Of the letter which she was writing, she knew nothing whatever.*"<sup>1</sup> [Italics are mine.]

In the case of B IV both sorts of writing have been observed, — the purely co-conscious, and the alternating variety.

<sup>1</sup> "Les Actes Inconscients dans le Somnambulisme Psychologique;" Rev. Philosophique, March, 1888. (Translation by Myers.)



## CHAPTER XXIII

### THE AUTOBIOGRAPHY OF A SUBCONSCIOUS SELF

SOMETHING has already been told of Sally's autobiography and of the catastrophe to which it was subjected. Some further explanation of the conditions under which it was written will make its import clearer.

In view of Sally's often repeated assertions that she had always existed as a separate and independent mind from early childhood, it was plainly of psychological interest that she should write an autobiography of her own mental life. She could therein describe her own relations to her environment, and contrast them with those of the primary consciousness. An account of this kind, in which the two streams of thought, feeling, and emotion, that of the primary and that of the "Hidden Self," should be described, so that the two selves could be contrasted, would be of value. In it Sally could tell of her own feelings, hopes, and desires, which she asserted were independent and distinct from those of Miss Beauchamp.

It would necessarily involve an account of the daily and petty doings of her life, and even the little secret thoughts that fill the recesses of a girl's mind. As Marie Bashkirtseff told every little secret emotion of her soul, so Sally would have to tell her own and Miss Beauchamp's. This Sally agreed to do and after many difficulties succeeded in doing, although she was careful not to disclose the secrets of others. Many things she told of which even Miss Beauchamp was ignorant, many things she saw which Miss Beauchamp did not notice, and many things she heard

which Miss Beauchamp never heard, for as a dissociated consciousness she claimed to see and hear much that did not enter the consciousness of the primary self. A good deal of this, of course, is too private to put into print.

The autobiography, then, is a descriptive history of a dissociated mind; but it also gives an introspective record of a well-organized secondary mind, of thoughts, feelings, emotions, and even of a "will," of which the personality whom we call the primary consciousness has no knowledge whatsoever, excepting of course so far as she has learned of it by the revelations of this study. Putting aside for the moment the question of the interpretation of the evidence, this record is a descriptive account of the alleged persistent flow of the two streams of conscious life from childhood to the present time. The subconscious stream has often been tapped by other observers, but I believe that this is the first occasion where a secondary self has spontaneously attempted to narrate its own subconscious biography. It is highly desirable that such a history should be confirmed by the accounts of other cases recorded by independent observers, in order that the degree to which the doubling of consciousness may take place may be determined. This duality, to whatever degree developed, whether rudimentary, or well organized as in Miss Beauchamp, is one of the most significant facts which modern psychology has revealed.

Miss Beauchamp, the saint that she was, was quite willing to put aside all her own feelings and allow Sally to write the story of her life, as has already been related. B II, also with the same sense of loyalty and a desire to aid those who were aiding her, gratefully made the sacrifice of her feelings.

With B IV, however, it was another story. She had no sense of duty or self-sacrifice. She felt that every hand was against her and she was against every one in turn.

Sally had dubbed her the "Idiot," and this sobriquet she thought reflected my early sentiments as well, especially as she knew that I disapproved of her ways and had sought to change her into another personality. This was enough to make her disbelieve all professions of interest in her welfare. It was not possible, therefore, to take IV into our confidence, since she would certainly do everything in her power to thwart us. "IV won't like it," Sally would say in warning, but we thought nevertheless that her wishes were not of much consequence, for, as Sally said, it was probable that she was n't "real anyway," even if she was more than a picture card, as Alice discovered her people in Wonderland to be, and if we succeeded in the end in changing her to the real one, the views of this somnambulistic lady would then be past history and belong to the land of unreality. It seemed unwise too, as a matter of discipline, to consult IV, although she was sure to discover what was being done. B IV, then, was not taken into our confidence at first. Sally endeavored to write the story without IV's knowledge, hiding the manuscript each day that IV might not see it. But this could not be very successfully done, for sooner or later Sally would of course be sure to change to IV in the midst of her work and then the jig would be up. This was in fact what happened.

IV of course flew into a rage at finding that her private life was being written out in cold ink, if not print. She bore it for awhile, but finally in fury and rebellion, as already narrated, she tore into bits the manuscript when this was nearly finished.

I had been so anxious to obtain this account of Miss Beauchamp's life, that when I saw this evidence of psychological vandalism I made no effort to restrain my indignation, unphilosophical as this may have been. My disappointment was too great for me not to be human as well as a physician, so B IV, I am afraid, was indignantly

reproached for her conduct. My discourse, if not just, was at any rate effective, for she agreed to allow the work to be rewritten, and never again to interfere; and this promise she kept, though at first it was in no gracious mood that she set about the task, but in an outraged spirit of indignation, as of one sentenced to penal punishment. Later she became largely reconciled, and I think was more bored than anything else by the work. At any rate, she did it pleasantly enough. It was agreed that an attempt should be made to reproduce the manuscript by "automatic writing," as Sally *claimed* to have a much better memory while she was a subconsciousness than when she was present or awake as the dominant personality. So Sally again began the task, making use of the hand of IV (or I) just as she carried on the colloquy with IV narrated in the last chapter. Several pages were reproduced in this way, but it was slow work; so IV agreed to allow Sally to devote a part of each day to the task, — Sally to write as the waking personality. Nevertheless from time to time some pages were written "automatically." It is necessary to bear this in mind in order to understand the comments of IV and the irrelevant interjections of Sally which are interspersed throughout the account and by which it is interrupted from time to time.

IV used to come to my study for the purpose of allowing Sally to complete the task. Sitting at the desk, pencil in hand, she would wait either for Sally to use her hand to write automatically or to be herself transformed into that young lady. Often becoming impatient for her other "subliminal" consciousness to begin, she herself would write some remark, generally personal, to Sally, who in reply would subconsciously write a pertinent retort, or IV would rub out a running fire of sarcastic comments on Sally's statements, muttering her criticisms under her breath for Sally to hear, — a most effective method for her purpose.

Or, again, IV would interrupt the account by writing comments on Sally's work or criticisms on her literary style, a matter on which Sally was particularly sensitive; indeed the latter was always quick to resent IV's assumption of superior wisdom and learning. IV at times became furious at some of the statements, declaring they were not true. These for the most part concerned events which occurred when IV was not in existence and of which she had no knowledge. Some of these interruptions have been preserved and inserted in the text. With this explanation they will be understood. Another matter it will be well for the reader to keep strongly in mind: it is the dissociated consciousness which is writing, and therefore it is the world as seen by this Self, and the feelings and thoughts as experienced by this Self which are described, and not the mental experiences of Miss Beauchamp, though the external facts were common to both.

After the autobiography was written I went over it with Sally, criticising and questioning some of her statements. Her replies, giving further information on certain points, are printed as footnotes.

### SALLY'S STORY

[The autobiography begins in a somewhat flowery, childish style with a few brief memories of infancy, while she was in her cradle. When I refused to accept the accuracy of her memory she went on as follows:]

(Revised for Dr. Prince, who questions the statements I have made and thinks I have not been sticking to the actual facts. I insist that I have, that everything I have written is fact, and that I do remember the night described when I cried for such a long time and some one tried to comfort me.)

I have not succeeded in drawing the bars of the cradle, I know, but that is immaterial. I remember the thing itself.

And the other days and nights too I<sup>1</sup> remember, when real and unreal things began to be strangely confused, and about learning to walk and talk. It was so hard at first. Afterwards I liked it better, for it was "willing," you know, — the first that I was conscious of. It was at this time too that I was conscious, not exactly of being a different person, but of being stronger in purpose, more direct and unswerving than I appeared, and of being in a certain sense opposed<sup>2</sup> to myself. This feeling was much stronger at some times than at others. Why, I do not know. Then first began my impatience with C., who instead of attending to whatever she might be doing would suffer herself to be distracted by a thousand and one things. For instance in walking, just as I would get most interested and eager to go on, down she would flop in a heap to study her shoes, to gaze at the people in the room, or to play with some treasure she had discovered on the floor. *Then* I was conscious both of the child on the surface, so easily affected and diverted, and of the other<sup>3</sup> child who was years and years older (I insist I was older) and stronger.

[Sally, when cross-examined about these statements regarding the date of the beginning of double consciousness, and asked for specific instances, made the following additional statement:]

"She was just a very little girl just learning to walk, and kept taking hold of chairs and wanting to go ahead. She did n't go ahead, but was all shaking in her feet. I remember her thoughts distinctly as separate from mine. Now they are long thoughts that go round and round, but then they were little dashes. Our thoughts then went along the same lines because we had the same experiences. Now they are different; our interests are different. Then she was interested in walk-

<sup>1</sup> There was no separation as yet.

<sup>2</sup> Beginning of separation of two consciousnesses. This separation was not continuous, but stronger at times.

<sup>3</sup> Myself as a personality distinct from C.

ing, and I was too, only I was very much more interested, more excited, wildly enthusiastic. I remember thinking distinctly differently from her; that is, when she tried to walk she would be distracted by a chair or a person or a picture or anything, but I wanted only to walk. This happened lots of times.

“Learning to walk was the first experience of separate thoughts. I remember before this there was n’t anything but myself, only one person. I don’t know which came first. I remember when I was there farther back than *she* can, and therefore why was n’t I the person?

“I remember lots of little things. When she was a little bit of a thing (so small that she could n’t walk very well) she had visions very often. I did n’t, but I was conscious of her having them. Her visions did n’t represent real things as they do now. I thought they were interesting and enjoyed her having them. During all her childhood I remember enjoying many of the things she did. She was awfully fond of out-of-door things, — climbing, running, etc. I enjoyed them and wanted to go farther than she did. Some people she liked I did n’t. Some people she went to see and talked with I did n’t want to see, but could n’t help it.

“I suggested things to her sometimes by thinking hard. *I* did n’t really do them; she did them, but I enjoyed it. I don’t know that I made her; I thought about them very hard. I did n’t deliberately try to make her, but I wanted to do the things and occasionally she carried out my thought. Most times she did n’t when my thoughts were entirely different from her own. Sometimes she was punished for doing what I wanted; for example, I did n’t like going to school; I wanted to play ‘hookey.’ I thought it would be awfully exciting because the boys did it and were always telling about it. She liked going to school. One day she stayed away all day after I had been thinking about it for a long time. She did n’t want to do it, but she did. She was punished and put to bed in a dark room, and scolded in school and made to sit on one end of the platform; she was shy and felt conspicuous.

“I always knew her thoughts; I knew what she was thinking about on the platform. She was thinking partly of being penitent and partly of fairy tales, so as not to be conscious of

the scholars and teacher, and she was hungry. I was chuckling and thought it amusing. I did not think of anything else except that her fairy tales were silly. She believed in fairies, that they were real. I did n't and don't. At this time she was a little girl. I was there during all the life with J—— and at —— College. I never forced her to do things till lately. Lots of times when she was a little bit of a thing I was angry when she was n't."

Finally this "double consciousness,"<sup>1</sup> or whatever you choose to call it, became fixed and continuous, although never reaching C I, or perhaps I should say, never felt as C I.<sup>1</sup>

It was only as C II that I felt it, but as C II it did not help me very much, for at that time I could not get my eyes open.<sup>2</sup> I have not expressed this well, I know, for in attempting to express it I get hopelessly "squeezed," the Idiot appears, and everything vanishes before her wrath,<sup>3</sup> since she does not approve of me or of Dr. Prince, or indeed of any one save Mr. "Teddy Jones," an old friend of the family, of whom I shall write more fully later.

In all this time until our first going to school there was little of importance that happened. C. was even then shy, nervous, and imaginative<sup>4</sup>—terrified by the appearance of her father, but worshipping, literally worshipping, her mother, who did not however care for her and paid her slight attention.

<sup>1</sup> That is, C I was not conscious of me, as she is not now.

<sup>2</sup> By this I mean figuratively, not literally; that is, I cannot be always present as the dominant personality. [By C II Sally here means herself, B III, not the C II she later mentions, p. 381. — M. P.]

<sup>3</sup> That is, she tears up my manuscript. [This refers to the interesting psychological fact, that when Sally thought deeply on intellectual subjects such as belonged to the primary consciousness she tended to change to I or IV. — M. P.]

<sup>4</sup> During all this time my thoughts were different from hers. We thought about the same things at the same time, but differently about them. Now we think about different things at the same time because my life is different from hers and I know things she does n't know.



(Not to be quoted to C., who will deny it, but it is a fact nevertheless, and one which I consider of great importance, inasmuch as it has deeply affected her whole life.)

The first day we were sent to school we ran away, and also the second day, so that it was long before we went again, but when we did go we stayed. C. liked it immensely and used to get awfully enthusiastic over her lessons and over her teachers, but I never cared for either. They were so tiresome and uninteresting. The school life and being brought into contact with different people changed C. very much. She was happier and not so shy and frightened, although at home things were just as bad as ever, and we were at home a great deal, for she was often ill. Then in the long vacations before J. came we used to be awfully lonely, for there was no one to play with, little to do, and we did not seem to be especially wanted at home. C. used to spend much of her time curled up in the garret away from every one, and then she was quite happy with her books and day-dreaming and visions,<sup>1</sup> but I did not care for them, for I knew they were n't true, — they never are. I liked much better being out of doors, climbing trees, etc., for it was more as if I and C I were "willing"<sup>2</sup> and doing it.

<sup>1</sup> Whenever C. had a vision she lost all consciousness of herself and her surroundings — not living, as it were, until the vision had passed. This was true, I think, in all instances except when she herself seemed to be a part of what she saw, and then, though equally lost to her real self and her real surroundings, she lived, but only in the vision. But I was always conscious, both then and now, of the *vision* projected against the *reality*, and was never confused, even for a second.

<sup>2</sup> In saying that I enjoyed such things as climbing trees, etc., I mean that doing them seemed to call for stronger "willing," which gave me a certain sense of power over C. and at the same time a certain feeling of being one with her. Our thoughts were the same except that she was not conscious of my existence. We were both "willing" together the same thing. But this feeling of unity lasted so short a time — only while we were actually making the *mental* effort required to overcome a physical obstacle. Other things she conquered alone, for they did not concern me — mental and moral things, I mean — I was not interested in them [e. g., lessons, trials, and tribulations].

The nights were horrible always, for C. either did not sleep at all or if she did she would have the most distressing dreams,<sup>1</sup> usually about her mother —

(Here the autobiography was interrupted for the day. When about to be continued B IV seated herself at the desk, with pencil in hand ready to have Sally make use of it to write automatically; she began as usual with a comment, and Sally of course retorted.)

[B IV. "Amanuensis, Sally dear, quite at your service."]

SALLY (to B IV). "Pig!"]

—and these dreams would send her flying from bed in perfect terror to listen for her mother's voice. If she heard it she would be quiet for a time — comforted — but if she did not hear it, then would begin one of those dreadful excursions through the house, through the streets, such as C. saw in the crystal a few days ago —

[B IV (to Sally). "*Months*, Sally."]

—and did not recognize. At least I am not sure whether she did or did not recognize it, for it was B IV who saw it, and B IV *never, never* tells the truth.<sup>2</sup>

<sup>1</sup> I knew they were dreams for the same reason that I have mentioned before in speaking of visions, — namely, that I am always conscious of things as they are and at the same time am conscious of things as they seem to be to C. and although of course the dreams are very different from the visions, yet they are equally absurd, and I do not know why C.'s fancying herself in dreams running about London should confuse me any more than her fancying that she sees London before her in a vision. In both instances I know that she is she, that I am I, and that this present is Boston.

There is a difference between her visions and dreams. In a vision she sees the scene, even though it includes herself, without any self-consciousness, *i. e.*, of her own actual body, though she may have the same feelings that she sees expressed by the vision body. It is the same when she sees things in the streets; *i. e.*, she has feelings suggested by the scene. In dreams she takes part in the scene and thinks and feels and does everything just as if she were awake in her actual body. I (Sally) never dream now, but when I was a wee little bit of a thing and learning to walk, before the double consciousness became fixed and when we were one part of the time, then I dreamed or she dreamed, for we were one at that particular time. This was in the little black cradle.

<sup>2</sup> [B IV insists that she did recognize the vision-child, but she has seen pictures of herself at 4-5 years of age. The rest of the scene she probably did recognize as the original scene. — M. P.]

The vision was of a long narrow street, snow on the ground, starlight, lots of trees, in the distance two men, very fat, half reeling along, and nearer, close to the first tree, a little shivering, frightened-looking child<sup>1</sup> with a small bundle in her arms —

[B IV (to Sally). “Provisions, Sally dear? Do tell me. And do, for goodness’ sake, ‘hump’ yourself. We can’t spend the summer here.”

(Here entered Dr. Prince: After reading the manuscript, I asked the subconscious Sally whether Miss Beauchamp ran about awake or as a somnambulist, and also whether the vision was true.)

The hand wrote, “Not somnambulistic.” “Open your eyes, stupid, I can’t see.” [B IV had closed her eyes.]

“Open your eyes, eyes, eyes,  
Open your eyes, I can’t see to write.”

Then, “God will punish your levity — I am a spirit. You know it is true.”

B IV. “Stuff! Write sensibly and answer Dr. Prince’s question.”

DR. P. “Was the vision true?”

SALLY. “The vision is true, and you know it, and I won’t write another word.”

(After this interruption B IV changed to Sally, who, no longer a subconsciousness, went on with the manuscript.)]

C. was not in a somnambulistic condition at the time of the incident seen as a vision. She had wakened in the night, and not finding her mother in the house went out in search of her, taking with her, not “provisions” as B IV suggests, but the old black cat which she had wrapped up to keep it warm. I remember it distinctly. The som-

nambulistic things were quite different. She was asleep then as a somnambulist — and B 2 went about and B 2 did all sorts of curious things different from dreams — different from visions. She usually had her eyes open too.<sup>1</sup>

Although there were many other nights when the same thing happened, she never took the cat but twice, and then only because she fancied that it was ill, and she did not want to leave it alone.

All this running about at night was the most absurd thing, and I mention it simply as showing how differently we felt. I was not nervous. I knew that the dream which had frightened her so was not true; that it meant nothing; that wherever mamma might be she would come home safely, as she always did; and that, if we were caught out of bed, we should be severely punished. But knowing all this did not help me in the least, I had to go in spite of it and in spite of my “willing.”

(At this point the “auto” was interrupted for the day. And when it was taken up again the next day I came upon B IV seated at the desk, pencil in hand, waiting for Sally’s humor either to go on with the writing automatically, or else to come herself and do it; but the hand had refused to write. It had pleased Sally for the moment to do nothing. B IV had become impatient, and as usual had occupied the time in writing messages to Sally:)

[B IV to Sally. “It will be for all the week, and Sunday, and start again on Monday, Sally dear, if you fail to do what M’sieu requires.

“This is serious, deadly earnest, too.” — “All the king’s horses and all the king’s men cannot help you then.” — “Come yourself and do it, if you prefer. Come, come, come!” — “Do you understand me?” — “Write yes or

<sup>1</sup> This is all right. “It was B 2 as far as I know. Only there was no B IV then, just “she” and I. B 2 I considered “she” asleep. — S. B.

[This B 2 is not the same as the B II of this study. — M. P.]

no." — "Write pig, write anything." — "Are you dead?" — "Were the scalpels and cupids too much for you, Sally carissima? Write, write, write."

(Here I also became impatient, and wrote the following message.)

DR. P. "Now do, Sally, hurry up. I am awfully busy and must get this done, so that I can do my work."

SALLY. "Copy it first; open your eyes."

B IV. "Copy what?"

SALLY. "You know."

B IV. "I don't. Everything?"

SALLY. "Yes, everything. Dr. P. said to."

B IV. "Punctuation, too?"

SALLY. "Everything, stupid!"

B IV. "I am charmed. Don't get stuffy. I wish you'd come yourself. Your constructions are simply barbarous. May I correct them?"

SALLY. "No, no, no, no. You let them alone."

B IV. "This, too? Next sentence?"

SALLY. "Yes, this too, next sentence. I wish you'd write decently."

B IV. "If you won't come I am ready to go on again. And if you will *think* 'decently,' I will endeavor to write 'decently.' Consider the beautiful tombstone you are going to have. Bee-yu-ti-ful! Does n't it inspire you?"

SALLY. "You are the most hateful person I ever saw."

B IV. "Thanks. I don't mind in the least, if you'll only write. Let's begin.

"You're a purple cow, Sally dear. Won't you begin?"

(No answer and a long silence.)

Here, being appealed to by B IV, I again took a hand and interviewed Sally, who wrote in answer to my appeals, "I won't, I won't," again and again.

I directed B IV to close her eyes, whereupon the hand wrote, "Open your eyes," objecting every time she closed them.

Finally, DR. P. (to Sally). "What do you want? Do you want to come?"

SALLY. "Yes, yes, yes."

So I brought Sally, who immediately broke out into complaints against B IV, charging that she bothered her by making all sorts of comments on her writing, and saying under her breath all sorts of disagreeable things; that she criticised her construction, her language, and so on. All this rattled her badly. Sally was much put out about it all, and very angry with IV, whom she abused roundly. Afterwards, when I accused IV of this, she excused herself, like a naughty child, on the ground that Sally did the same. So it was pretty much of a muchness. Each taunted the other unmercifully. [The seriousness with which each took it was quite comical.]

. . . We felt differently about everything, I think, until J. came. C.'s whole life, all her thought and action and feeling, centred about her mother. She believed that God wanted her to save mamma from some dreadful fate, and that in order to do this she must, before the day should come, have attained a certain ideal state mentally, morally, and, I think, spiritually. Everything that came up was tested in its relation to this; she was always fretting about it, always dissatisfied with herself, and fancying that she fell short (as she did).

This impossible ideal *haunted* us day and night — there was no escaping it, although I must state, in fairness to C., that at that time it was not perfection as an end that she strove for, but perfection as a means of attaining something else. Now it is different; she has grown morbid, unreasonable, and most exacting, not only with herself but with others, and this, although she no longer believes that she is fitting herself for something. I think that after so many years she has acquired a habit of thinking along certain lines and cannot drop it. People who know

her (B I) would probably say that I am entirely wrong in stating that she is unreasonable and exacting, but she is, nevertheless. Not in the ordinary way, perhaps, — that is, not outwardly. But if one believes one's friends to have certain qualities —

(This train of thought was not finished.)

. . . We grew farther and farther apart in our thought and feeling, and finally it was almost as if we had changed places again. I hardly know how to explain it better. For you know in the beginning I used to be conscious of the child on the surface, easily affected and diverted by her own thoughts and by all the little happenings about her, and of the other child (that's me) years and years older, who held steadily to her purpose and was unwilling to be diverted by anything. *Now* it had all changed; although I was still conscious of them both, it was the one on the surface that was steadfast and unswerving and the other (myself) that was interested and attracted by the thousand and one things of no particular importance that were passing about us. So that as a rule in any given scene or incident C. would take in only what might be expressed as or the thing itself. C II<sup>1</sup> would be conscious of more details, while I would be conscious not only of the thing itself with all its details, but also of much beside. So that in trying to recall anything, if it comes as a *memory* C I sometimes gets details that were noticed only by C II. She *never* gets any that were noticed only by myself. But if the scene or incident is recalled by a *vision* then she does sometimes (not often, I think — I am not sure) get it as I saw it, and then she (I, not IV) says and believes either that the vision is not true or true only in part.

<sup>1</sup> I say C II because I do not know how else to express what was in C.'s mind as apart from mine and which she was not conscious of at the time, but which she remembers when hypnotized. [This C II corresponds to the normal subconsciousness. — M. P.]

[SALLY (to B IV, referring to some copying of manuscript that Sally was to do). "Did n't do it, did you? Amen. Amen."]

C. was always in hot water then, because she used to go mooning about, not knowing half the time what she was doing; and, although I knew perfectly well, it was not often that I could help her. Now since I got my eyes open I can and do help her a great deal by finishing what she is doing and writing letters for her and to her for her information. Sometimes she is so absentminded she forgets; then I help her out sometimes. Sometimes the only way I can do anything is by coming myself, and this kind of help she (C.) does n't appreciate, but she ought to. It is infinitely better than the way things used to be when we were growing up, and it relieves her of lots of responsibility. I tease her too, of course, but not so much now, — not since B IV quarrelled with J. and refused to see him again; because it was always things about J. that teased her most. She never wanted me to go anywhere with him or even speak to him, although she herself has done exactly the same things that she complained to Dr. Prince of my doing. She used to dress for J. all the time, and once she cut all her hair off short for him so that she looked like a curly-headed poodle, and afterwards she was going to do it again, and would have done it too if Dr. Prince had not shut her up in the hospital. The only difference there has ever been in our relations with J. except at first (after mamma died and he came, I mean), when I did not like him particularly, because he was so tiresome and because he did such queer things which C. was not conscious of but I was, things which people do only when they are cross, yet he was never cross with her apparently —

[B IV. "Such constructions, Sally dear! Won't you, *won't you* make them the excuse for sacrificing this! Let Jones alone. Take me."]

— The only difference there has been —



[S. B. "My constructions are perfect, and I don't think you agree with me to-day. I prefer Jones."

B IV. "'Is that the wind dying,' Sally dear?"

SALLY. "Bah! you only threaten."]

— They used to read together and then —

[B IV. "I never read with him in my life."

"You did, B IV, you<sup>1</sup> read to him by the hour when you were n't chattering like a magpie. You could n't see him then — but I could, and sometimes C II saw him do things too, like cross and angry people. That is,<sup>2</sup> you half consciously saw him while you were reading and talking, without your knowing it, but I did. So that one part of your mind read and the other saw J. unknown to the first part (I was separate). You were so absorbed in the reading, you did not notice what you saw at the same time. I call this part that saw, C II. I saw and recognized things at such times independently."

B IV. "Your English pains me, really. Destroy this and make some excuse to M'sieu. You know I cannot."

SALLY. "It's Jones that's painful, not my English, and I'm afraid he'll be even more painful before I've finished. I'm going to tell everything, all about — and all — because it's interesting psychologically. Amen — Amen —"

B IV. "Stop — stop!"

SALLY. "He did things as if he were cross, lots and lots of times. *You* would n't have known if he'd been standing on his head — you never knew any of the things

<sup>1</sup> ( That is, Miss B. as C.)

<sup>2</sup> The next five sentences in the text are an after elaboration made at my suggestion. In illustration of this fact that a part of B I's mind saw while the other part did not see, Sally mentioned the following incident: "Last night B I saw Dr. P—m in the car. She looked at him straight. He was sitting opposite, and there was no one else in the car. She was thinking of something and was not conscious that she saw Dr. P—m, but there was something in her that did see and recognize him apart from me. This part is what I call C II."

that I knew, and you don't now. You are n't real anyway. 'Teddy' was *just* the same then that he is now, only you were too stupid to see it. And it proves what I said before, that you are unreasonable and exacting with people because you believe them to be other than what they are and then are disappointed and broken-hearted and everything else because they don't, because they can't, live up to your absurd expectations — and I don't believe a word of what you say. You have n't got B I's memories. You don't know anything about her, you don't. . . ."]

. . . I cannot analyze C's absorption, preoccupation, whatever it was during all those years that prevented her from seeing things as they really were — as I saw them — and which got her into such an endless amount of trouble. I think there were several reasons for it —

[To B IV. "If you talk to me any more<sup>1</sup> — if you say another word I shall tell Dr. Prince."

(Here B IV twitted Sally with being afraid of Dr. P.)

"I'm not. *I am not*, but I won't have you spoiling everything I do."

B IV (aloud). "What does 'Amen' mean?"

SALLY. "It does n't concern you the least little bit in the world. — No, I won't!"

— some of which still exist. The chief one of course being her fancy about mamma. But there were others too. She was dreamy and visionary, as I have said, seeing things always rather through her own thought than clearly and truly; and at the same time, despite her dreaminess, she threw herself with great intensity into whatever she might be doing, so that in all her relations with J. before I got my eyes open she saw him and thought of him in an entirely different way from what I did. So with Mrs. X., with

<sup>1</sup> B IV kept coming and going and talking aloud for Sally to hear as yesterday. This refers to B IV's slanging her.

Dr. P., with nearly every one we knew. There were a few people whom we both liked, but even then we liked them for different reasons — C. caring for them for what she *fancied* they were, I for what I *knew* them to be. . . .

As I said, she used to read to him by the hour thinking that he was entirely absorbed in it, but he was no more absorbed then than he is now when B IV rows him for thinking of her instead of what she is saying. — [To B IV. “I won’t come unless I choose. Ask Dr. Prince if he’s cross with me — ask him, stupid — ask him, ask him, ask him.”] . . .

I haven’t yet told about J.’s first coming, nor about mamma’s death, nor any of those things, although I suppose they ought to have gone in long ago. I think before I began writing about J., I was trying to show how by C.’s allowing herself to be ruled by one idea we grew farther and farther apart until by the time I got my eyes open, and even before that, we had scarcely anything in common. Sometimes I used to feel sorry for her, but more often impatient. There were so many things that she was unreasonable about, so many things that she could not or would not see — would not, I think, for it is the same still. She holds to certain beliefs and ideas with unwearying patience. It makes no difference that the facts are all against her. It makes no difference that people never or very rarely live up to her expectations. She still ignores the facts, still idealizes the people.

By “she” I mean always B I. I know nothing whatever of IV’s thought and feeling — *if she has any* — she does n’t belong here anyway. . . .

Perhaps there were other reasons besides the one about mamma for our growing apart. C. always does things very differently from me. She is so tremendously in earnest, and I don’t think I am — not often — for it makes me feel squeezed. [*Please — please — please — find me*

another word, Dr. Prince. I don't want B IV to see this.] — And her being so in earnest helped to separate us too, and accounts, I suppose, for her knowing so much more in certain directions than I do, about books and pictures and those things, I mean. . . . But when I came J. was glad enough to drop all that and be simply himself. He was perfectly bewildered, though, at first; he could not understand how I had changed so suddenly and so completely. It was amusing too, his saying often that he did n't know whether — [unfinished] . . .

[SALLY (to B IV in answer to some remark, probably protesting). "I won't, I won't, I won't. I don't care *that* for you."]

. . . Mamma was very ill for a long time before she died, and during this time C. did all sorts of absurd things so that I did not know for a long time what she was thinking about. No, she was not at all like B IV, but she had hallucinations of hearing and sight very much like the pneumonia delirium, and the doctor said she was threatened with brain fever. She was not "real," you know, not herself. I hardly know how to describe it — it was so dreadful — worse than anything that had ever happened. I used to want to come — to be outside again<sup>1</sup> — but I never could, and I did not know then how much it is possible for me to influence C., even when she is in this queer state, without coming, without being outside. When I am outside now they seem to be dead. At least if they are n't I don't see what has become of them. They are n't in me because I am always just one. If they were, I should have all their knowledge as well as their memory and feeling, and I have n't. But B IV must be C. rattled, even if I don't know her thoughts, for we are still connected in some way, else I could not make her see and hear things and not see and hear them. Perhaps it's through B II, yet it can't be

<sup>1</sup> Referring to the period of infancy.

the real B II, for I always know what she thinks — always — although Dicky says he thinks I don't when it's B IV that is hypnotized. He says there is a part I cannot get. . . .

However, to return to the time of mamma's illness. C. fancied that it had all come because of her; that she had fallen short of God's requirements. She tormented herself, and me too, night and day with going over, and over, and over, everything that had happened since she was born, thinking this, that, and the other, — that she had not been earnest enough, that she had not loved mamma as deeply as she should, that she had been dreaming away her life instead of acting. It was all rubbish. She had never done anything then. And as for mamma, she never wanted C. near her after we grew older. She didn't even want to see her, but was always saying, "Keep out of my sight." And I know why, because of something that happened once when C. had been taking medicine and was sound asleep — If I had been asleep too I should n't have known it. . . .

. . . Just before mamma died C. had a severe nervous shock which affected her in some way, so that I did not know, except occasionally, what she was thinking. We were separated just as B IV and I are now. C. had been very restless and nervous during the day, had been scolded and sent to bed several times that evening, but had finally managed to steal unnoticed into the room where the baby was kept to prevent its disturbing mamma, for it cried incessantly. She took it in her arms — nasty squally little thing<sup>1</sup> — to soothe it, and after a time it grew quieter; then still more quiet, until finally it gave a curious little gasp and stopped breathing altogether. But C. had not noticed it, for she had entirely forgotten the child in going over and over for the ten thousandth time her sins. She sat there gazing into

<sup>1</sup> B IV and I do not like babies; C. does. B I and I do like animals; B IV does n't. I like toads, spiders, etc.; B I and B IV do not.

space until morning, until the nurse came, and for a wonder the nurse was n't cross. She simply kissed C.'s forehead and took the child out of her arms. Then she started a little, asked C. how long she had been there, and how long since the baby had stopped crying. But she did n't say it was dead. She said it was better, but that C. herself would be ill unless she slept, and she begged her to go and lie down. C. did not know until late that afternoon, when she heard the nurse telling some one, that the baby had died in her arms, although I knew immediately that it must be dead.<sup>1</sup> . . .

Soon afterward mamma died too, and then I lost C. for a time — for weeks, I think — during which she went about and did things much as usual, apparently. But it was only apparently, for at night when we were alone again —

(The "auto" being interrupted, the account of C.'s mental condition following her mother's death is unfinished. She was in a disintegrated condition.)

. . . Have I said enough about mamma's illness, death, etc., and C.'s curious mental condition at that time? . . . The next thing of any great importance that occurred was the beginning of C.'s<sup>2</sup> friendship with J., which was really the beginning of a new life, so much fuller was it in thought and action than the old had been. We saw him first shortly after mamma's death, and C. both at that time and often afterward fancied him unreal, sent as a sort of heavenly messenger to reassure her about mamma. And not only was she puzzled and confused with regard to him, but with regard to everything else that happened during that year. Her account of that time as given to J., to Mrs. X., and to Dr. P. is *false* in nearly every particular,

<sup>1</sup> I always see and know most things more quickly than C. does, but I do not seem to *know* them more quickly than B IV guesses them.

<sup>2</sup> My own did not begin until years and years afterwards.

although she herself and, I think, the Idiot still believe it true. J. believes it also and fancies that he remembers certain things as having actually occurred. But he does n't, nevertheless. He was for the greater part entirely dependent upon C., and what he now thinks he remembers as having occurred then he really remembers only because it was told to him then. He used to believe everything C. said before I came. He does n't now.

I do not mean that C. deliberately planned to mislead him, but that she herself could not distinguish between her visions, hallucinations, impressions, whatever you call them, and the reality. She honestly believed herself the victim of fierce persecution, and her intensity, together with his absolute faith in her, forced this belief on J. also. It was very funny. He used to sympathize so heartily and give such amusing advice, never questioning anything. I find it most difficult to try to make you understand clearly her mental condition at that time. Things did not happen at all as she says, yet in her account of them the hallucinations are so cleverly interwoven with real happenings that it is hard to distinguish between them. J. could not, and I think you have n't<sup>1</sup> . . . I could not tell J. all this, for I never talked to him then, but I knew it just as perfectly as I do now.

Despite all this mental confusion and inability to recognize her hallucinations as such, C. was on the whole very much more reasonable, more like other people, I mean, from the time of first meeting J. until the time he frightened her. She gradually ceased to think of mamma as suffering, of herself as being responsible, although there were times when the old feelings seemed to return with great force and I was afraid she would give in to them. But having so many other things to think of and J. to talk

<sup>1</sup> All these details of her early life have been omitted in the biographical account given in the first two chapters.

with helped her. She dreamed of devoting her life to him, of being always with him. To express it differently, he was the second divinity to whom she did reverence, mamma having been the first. Mrs. X. was not the third, but a continuation of mamma, and so first, I think. The others, greater and lesser, may be arranged some other time. They are n't very interesting except perhaps as showing how differently they were ranked in our respective minds. We always saw them differently and hence cared for them in different degrees. I'm not sure, though, that I do not like myself best of all the people I have known. By myself I do not mean I or IV, I mean just Sally Beauchamp. At any rate I do not get tired of myself as I seem to sooner or later of every one else. . . . To return to C.'s fright, however. Dr. P. seems to think it changed her to B IV.<sup>1</sup> But it did n't. IV came years and years and years afterward in Boston. She never saw "Providence." As for C.'s being profoundly affected by that night's experience, it is absurd. . . . If she had n't been so stupid she would have listened to his explanation instead of repeating over and over again like a parrot, "Oh, go away, go away, do go away!" She did n't hear anything he said, but I did and know all about it now. No one else does, except possibly C II, who often sees and hears things which B I and IV know nothing about. But seeing and hearing do not make her real. The only "real" ones are C. and myself, II being C. asleep, and IV, C. rattled. Sometimes she is more rattled, sometimes less, but that does n't alter the fact that she is still C. It is confusing to have so many names for her and I do not like it. . . . J. did "go away" finally and did n't come back. He sent a great, great many letters to tell C. how sorry he was, but she would n't open any of them, even when they were directed in different handwriting. She sent them all back at first,

<sup>1</sup> This, of course, is an error on Sally's part. It changed her to B I.



afterward she dropped them into the fire, and I was simply aching to read them. Not because I cared particularly about J; I did n't, but neither did I care about C., and of the two he was certainly much the more interesting, for C. was "off" again, just as after mamma's illness and death. C. became much as she had been then, only she did not have hallucinations, visions, etc. She became B I. No one seemed to recognize this change, however, as she kept on with her work just as usual. They would have been much more likely to notice her eccentricities had she been brought into closer contact with them, but coming on duty, as she did, when every one else was going off, and being alone all night save for an occasional visitation from Miss Y., she escaped criticism. They commented on her pallor and on her extreme nervousness, but these things were nothing new, and were ascribed to her inability to sleep. Miss Y. indeed used to hint that she feared for C.'s reason, but she never said anything very definite. I think she was puzzled and interested, and wished C. to believe that she knew a great deal more than she really did. . . . Miss Y. appealed to her sympathy, besides having a peculiar sort of fascination for her in being different from any one else she had ever known. She interested herself in all the things C. cared for, devoting herself to the children, telling of her experiences among the poor and discussing books, music, etc., by the hour. She had to do most of this at night after every one else had gone to bed, as Miss E. watched her constantly during the day. She would appear about one or two o'clock with a book and urge C. to lie down and rest while she kept watch over the patients, but as C. never would do this she finally contented herself with sitting and talking, sometimes until daylight. (This was really very curious, for now she has to have ten hours' sleep *every* night.) All this to account for Miss K.'s presence in the room when J. came [at the window]. Earlier

in the night there had been a heavy shower which had made the children, and some of the other patients as well, quite restless. . . . C. herself was nervous and excited, questioning almost for the first time the [course which she ought to pursue.] . . . She had been wanting for weeks to write Miss D.<sup>1</sup> about it and J.'s refusal to allow this troubled her greatly. I should have said before, I suppose, that knowing Miss D. entirely changed C.'s conception of many things. . . . As a child and as a girl she had been so much alone, so dependent upon herself for the solution of all problems that troubled her, that she had gradually come to be guided by laws of her own making, ignorant of those already existing for mankind. This despite her early belief in God and her desire to live and die for mamma. However pious and devout all that nonsense may seem at first, when analyzed it resolves itself simply into an expression of the same feeling which later led to her devoting herself to J. . . .

Of so-called "religious instruction" and "ethical training" we never had any. Until after mamma's death we had never been to Sunday-school but once, as a visitor, and never to church but twice. I think that's why I hate it all so much now. Mamma had told C. that she must never, never tell a lie, never be in any one's debt, and never do a mean or cowardly thing. This was all that C. had with which to build until J. came and afterward Miss D. I am not forgetting her school life. That brought greater problems rather than added knowledge in this respect.

When J. came, although he was familiar with such things, he seemed infinitely to prefer listening to C.'s fancies to expressing any opinions of his own. He thought her awfully good, but "the most unconventional child" he had ever seen. Occasionally he would correct and suggest, but not often. With Miss D. it was very different. She cor-

<sup>1</sup> Later Mrs. X.

rected, suggested, marched C. off to church, laid out a course of reading for her, and in various other ways helped to develop her infant mind, greatly to J.'s amusement.

(The remainder of the autobiography was carried off by Sally and secretly buried in her box of treasures in the woods.)

Aside from the interest pertaining to the biographical account of the early influences which tended towards the disintegration of the primary personality, the value of this autobiography, if substantiated, lies in the description of a dissociated mind, and of the alleged cleavage of consciousness dating back to early childhood, and of a fairly continuous and organized subconscious life from that date. According to Sally's memory the separation began somewhere about the period when the child was learning to walk, whatever age that might have been. Sally, having no notion of time, does not realize the significance of age, or have any idea of her own age at different periods. To say she was two years old, or ten, would have the same significance to her. We cannot be too cautious in accepting introspective statements of alleged phenomena, and however difficult it may be to explain the statements of the "autobiography," judgment should be suspended until we have a wider knowledge of the possibilities of abnormal psychology than we have to-day. It should be pointed out, though, that in *kind* the phenomena do not differ from those recorded throughout this study.

In interpreting this account we must entertain a critical scepticism on several points: first, the truthfulness of the writer; second, the reliability of her memory; third, the nature of the cleavage of consciousness.

As to the intentional truthfulness of the writer. On this score there are two kinds of evidence: first, that which pertains to a belief in the honesty of the witness, as in court a jury is called upon to decide the truthfulness

of a witness from the impression of honesty made by his character, personality, and manner of testifying. Unfortunately it is not open to the reader to form a judgment from this kind of evidence. Speaking for myself, I can only unqualifiedly state that it is my belief that Sally firmly believes in the truthfulness and accuracy of her own statements. The second kind of evidence of the honesty of the writer is to be found in the content of the writing. This kind of internal evidence must be judged by each one for himself.

As to the second point — the reliability of Sally's memory — although I have often experimentally proved Sally's memory to be in many respects far superior to that of an ordinary primary consciousness, — a peculiarity, I believe, of subconscious phenomena, — nevertheless it must be open to tricks and hallucinations, like the memory of ordinary people. Every one is liable to hallucinations, commonly called illusions of memory, by which events which have simply been learned by hearsay seem to be remembered as events which have been actually experienced. Sally indeed thinks she can remember events in her life dating back to a time before there was a separation of consciousness and which she places in infancy. But the date is an inference, and the facts of perception, like that of her cradle, she could well have acquired and probably did acquire at a later date. She might well have been placed in her cradle on some occasion when comparatively quite an old child. It is not uncommon, I believe, to find people who remember events which happened at three years of age. But a memory going back to infancy is without doubt an hallucination similar to what many people have.

More important, however, for critical examination is her memory of the beginnings of division of consciousness. This separation was gradual, and at first, even by her account, seems to have been ill defined, embryonic. She

dates the earliest beginning at the period when she was learning to walk. It was apparently towards the end of this period that, according to her memory, which may here err, the *development of a secondary consciousness* took place. This would appear to be somewhat young for the development of pathological secondary states and the division of consciousness. Yet automatic phenomena indicative of doubling have occurred at a very early age; hysteria sometimes occurs in childhood. Catherine of Siena had visions at six years of age, according to her own letters.

As to the nature of the cleavage of consciousness, we may ask, Does Sally's statement, assuming that it is not an error of memory, necessarily mean that a subconscious personality had developed at the early period given? To my mind a rational interpretation would be that the present subconsciousness (Sally) remembers a number of isolated subconscious perceptions and feelings which as subconscious phenomena were more or less normal. Remembering them now, they seem to be her own personal experiences, just as I have explained the hypnotic consciousness remembers isolated absentminded perceptions, or the lost isolated tactile sensations of anæsthesia, as its own. Indeed this is just what occurs with those perceptions which make up the fringe about the focus of our ordinary conscious attention. This fringe we are only half aware of or not at all, but in hypnosis the hypnotic self remembers it as its own conscious experience. I have made numerous experiments proving this, and have shown that when all the personalities are synthesized into one, there is a wide fringe of this kind in Miss Beauchamp's case. So I conceive it is possible that Sally, as at present organized, may now synthesize the memories of normal subconscious states belonging to childhood, and remembering them as the experience of her own personality, seem to herself to have lived as a whole in the past. This is suggested, for instance, by the follow-

ing sentence: "I was conscious both of the child on the surface, so easily affected and diverted, and of the other child (Sally) who was *years and years* older (I insist I was older and stronger)." This looks as if she were *retro-jecting* her present self into the past. On the other hand, it must be confessed, it is difficult to reconcile this explanation with the fact that Sally clearly recognizes the normal subconscious states of her childhood and designates them as C II, distinct from her own thoughts. It is interesting to notice how distinctly some of Sally's statements of subconscious life embody the teachings of modern psychology.

It is difficult to accept without further and positive proof that such a large systematized self could have been organized subconsciously in early childhood; and yet if this interpretation be rejected what view shall we take of the similarly systematized self apparently manifested at the time of this study: like that of sane Sally while B I was delirious (Chapters VII and XI) or that described in Chapters XXII and XXVI.

A second alternative hypothesis is that Sally's whole memory of her subconscious experiences during childhood is a hallucination. If this were true it would be almost equally interesting. But to my mind this theory involves too much. It is incredible that such an enormous systematized hallucinatory memory into which are woven a mass of true memories, as corroborated by Miss Beauchamp, could possibly arise particularly in a mind possessing a memory as accurate, precise, and large as Sally's. It should be said that the main social facts of Sally's autobiography are corroborated by the Real Miss Beauchamp as well as B I and B IV, though the point of view taken by the different personalities of many of these facts is characteristically different. This of itself is of psychological significance.

Finally, it may be pointed out that the automatic subcon-

scious phenomena exhibited in my presence during the writing of the manuscript and recorded in it are of a very unusual character and worth preservation.

Sally's autobiography must stand as it is, open to various possible interpretations; yet it deserves to be put on record to await the observation of future cases.

## CHAPTER XXIV

### HOW B I AND B IV WERE MADE ONE PERSON, AND THE UNEXPECTED CONSEQUENCES

TOWARDS the end of April, 1900, there was a lull in the storm. The barometer had risen and it seemed a good opportunity to make another attempt to fuse Miss Beauchamp and B IV into one personality, and thus, on the hypothesis tentatively adopted,<sup>1</sup> regain a complete and presumably the original self. The early attempt to do this, begun some months back, had been interrupted by various vicissitudes of family strife. But at last B IV had become convinced, for the moment at least, of the impracticability of the present family arrangement, so she agreed that a systematic effort should be made to amalgamate B I's memories with her own.

My idea was that if B I and B IV could be fused into one character, a fusion which would be the resurrection of the original Miss Beauchamp and the restoration of the original mental relations, Sally would sink out of sight and disappear into her original subconscious abode, if she had one.<sup>2</sup>

To dispose of Sally in this way after our long friendship seemed cold-blooded, and I confess to certain qualms. But what was to be done? All three could not live. The

<sup>1</sup> See Chapter XVIII.

<sup>2</sup> Because, among other reasons, with the synthesizing of the dissociated personalities into one personality, a considerable part of Sally's field of consciousness, e. g., the motor part, would also be amalgamated with the main personality, and Sally's field would be so far despoiled that there would not be enough left to constitute a personality capable of independent spontaneous activity.



choice had to be made, and the law of psychology condemned Sally. Sufficient only of this plan was told B IV to obtain her co-operation. More than this I did not dare disclose, for if Sally got wind of the whole scheme, as she certainly would if I revealed it all (for she heard whatever was said<sup>1</sup>), she would do everything in her power to thwart my endeavor to get rid of her. This, in fact, was always an obstacle in the reconstruction of the original self, for whenever Sally found herself sinking out of sight, "squeezed," she bent all her energies to frustrate my work. The ingenuity which she displayed in devising schemes to circumvent every attempt to bring order out of chaos would have done credit to Machiavelli. Miss Beauchamp she easily checkmated by suppressing her letters and by innuendoes, hints, and even by forging letters,<sup>2</sup> which gave her to understand that I had had enough of her and was unwilling to bother myself further with her case. IV she terrified by perverting the statements of B II, making it appear that II revealed in hypnosis private matters which as IV she would almost sacrifice her life to keep secret; she also told IV that as B II she yielded that obedience against which IV had constantly struggled; while both B I and B IV she tormented until they were physically worn out. In this way they were kept in a nervously unstable condition in which they could be easily controlled by the subconscious self.

On this occasion, when the plan for amalgamation was explained to IV, this personality insisted upon asking awkward questions about what was to be done with Sally; whether she would be suppressed for good, and whether IV would know all her thoughts, etc. These were very awkward questions, considering that Sally was ready to

<sup>1</sup> This would be practically true whatever theory of Sally be adopted, — whether that of a continuous subconsciousness or of an alternating self.

<sup>2</sup> E. g., see letters of October 5, p. 434, and October 8, Appendix N.

take the bit in her teeth at the first sign of danger to her freedom. Fortunately, I succeeded in parrying the questions sufficiently well not to excite Sally's suspicions.

Accordingly, B IV or B I, as the case might be, was hypnotized daily and the proper suggestions given to B II. The results in many respects came up to my anticipations. Space will allow only a brief résumé of these experiments, enough to make the consequences intelligible. A character was obtained which had all the memories of the daily life of B I and also of B IV. But more than this, this character seemed to be, as far as one could prove, neither B I nor B IV, but a composite of the two, although more like B I than B IV, just as the Miss Beauchamp of early days in character more nearly resembled B I.

Differences of character are much more easily recognized than described. It is still more difficult to substantiate the evidences on which the determining of character depends, for psychological characteristics are not subject to mathematical measurement. Still the difference between good temper and bad temper, between frankness and reticence, between good-will and bad-will, between the desire to help and that to hinder, between a tendency to idealism and one towards cynicism, between emotionability and calmness,—differences like these are easily recognized and even proved by simple test reactions.

By such differences, which obtrusively forced themselves upon one and which had to be tactfully accepted in handling the case, it was easy to see that the new character was neither B I nor B IV. She had lost the reserve, the depression, the emotionability, and the idealism of B I; but she had also lost the quick temper, the lack of faith, the resentment, and the cynicism of B IV. She was a person of even temperament, frank and open in address— one who seemed to be natural and simple in her modes

of thought and manner. Yet she more closely resembled B I, and might fairly be regarded as B I restored to a condition of healthy-mindedness.

But it did not often happen that the new personality was as complete a fusion as this. Sometimes "It," as Sally humorously called her, was distinctly B I or distinctly IV; more or less modified, but with the memories of both. At such times the fusion of memories was not always complete; that is, it did not include the whole life of B I and B IV, but only specific events or periods of time. Between these two extremes many variations were observed, the mixture at one time partaking more of the characteristics of B I, and at another time of the characteristics of IV, and sometimes being a mixture difficult to identify as either. The exact kind of person one would get as a final product was always uncertain. It depended largely upon the status of the family concord and upon the acquiescence of Sally and B IV; but also upon the formula used to wake the new person. If B II was told to wake as B I with all the memories of IV, the new person was more like B I; and *vice versa*. But when the most finished product was obtained the fusion was a character which was neither B I nor B IV. She remembered herself as B I; she remembered herself as B IV. When asked, "Which are you?" she would say, "I don't know which I am"—a reply dictated by the fact that she knew both her other existences, and recognized the likenesses and differences between them and herself.

It would be confusing to designate with a single name a person who varied in character within such wide limits,—from a completely fused personality to a modified B I, at one end of the scale, and to a modified IV at the other. If we name the complete or a relatively complete fusion "The new person" as I did, then the less complete forms may be termed the New B I and the New B IV, these

being more or less modified B I and B IV, with more or less synthesized memories. Such terms are necessary for a clear explanation of the experiments.

Although the most finished product—The new person—was only occasionally obtained, *nevertheless getting such a person at all was a demonstration of the fact that a synthesis of B I and B IV could be obtained, and that to all appearances this synthesis was a normal individual.* It was plainly more stable and less suggestible than either B I or B IV, and better adapted to resist the disintegrating effects of the environment. It was much less subject to the little “traumatic neuroses,” the nervous shocks to which Miss Beauchamp was subject. The ordinary frictions of life, a hasty word, or annoying action, which would have caused in either B I or B IV an emotional disturbance with all its dire results, tended to pass off leaving the surface of the new person’s mental life scarcely ruffled. In this she approximated normality. This degree of stability diminished according as the fusion was less complete and the new personality approached B I or B IV in character. Still even “New B I” and “New B IV” were more stable than the unmodified B I and B IV.

The new personality tended to remain fused for varying periods, lasting from a day to a week. Here again, the more complete the fusion the greater the stability. The modified B I and B IV generally persisted but a few hours, relapsing soon to their original states.

A matter of importance, as we shall see, was the memory on the part of B I and B IV for the new person. *When the fusion was complete both B I and B IV had complete amnesia for this new self.* Neither of these disintegrated personalities had any recollection whatever of the periods of time when they were transformed into the completely fused and most stable personality. The same was found later to be true in respect to the Real Miss Beauchamp

when finally obtained by another method. But when, as was most often the case, the fusion was incomplete, and we had only a New B I or New B IV, then, after reverting again to old B I and B IV, each of these latter personalities retained a memory for the thoughts and actions of the new personality. This proved to be a matter of considerable importance, as it had dire consequences which will be presently related.

The characters of the various new personalities were clearly recognizable in their letters, in which one missed the morbid saintliness of B I and the vigorous pertinacity of IV. They exhibited rather a healthy-mindedness, though this varied with the stability. The modifications of personality may be thus summarized:

(a) New B I, modified by the ideas, memories, and traits of IV.

(b) New B IV, modified by similar acquisitions from B I.

(c) Intermediate states.

B IV and B I each, after returning to herself, remembered all these new states.

(d) The new person, an apparently complete fusion. Neither B I nor IV afterwards remembered this state.

That the new person was the original Miss Beauchamp did not necessarily follow. That was a matter for objective identification. Theoretically, she might be only an artificial creation. Yet the possibility of artificially fusing the elements of the two groups of conscious states into one personality, much as one might by a chemical synthesis make a new chemical compound, is not without interest.

This synthesis is an interesting study in itself, aside from the story of Miss Beauchamp's fortunes. The modes in which the peculiarities of each character were modified by the acquisition of the ideas, memory, and one or more character traits of the other personality, is in itself well

worthy of inquiry. Such a study is bound to throw light upon the meaning of character, but it is not easy, — perhaps as yet not possible, to interpret the results correctly, or to trace the resulting alterations of character to their true psychological basis. Limitations of space prevent my entering upon a detailed description of the modifications observed, but a few general conclusions may be stated. As far as *memory* went the synthesis was simply a combination of the memories of both personalities. The same was true of the faculties and educational acquisitions which one or the other character had lost. For example, it will be remembered that sometimes B I and sometimes B IV lost her knowledge of languages while the other regained it. In the fused personality this knowledge was retained.

Some other characteristics of the new personalities, particularly of the completely fused new person, were plainly to be regarded as the resultant of the fusion rather than as simple additions. The characteristics referred to are perhaps to be summed up by what we include in the term *mood*; the absence, for example, of morbid depression, of emotional impressionability, of exaggerated points of view, idealism, etc. Other characteristics again appeared to be feelings and emotions which were introduced into the resultant consciousness apparently by the force of the law of associated ideas. As when, for example, the mere awakening in New IV of the memories which belonged to Miss Beauchamp brought at the same time all the associated feelings and emotions of the latter, though toned down and modified. Other characteristics again seemed to be the resultant of a return to normality; as, for example, the disappearance of the neurasthenic symptoms and the return of physical and mental states of well-being and healthy-mindedness. The new person was comparatively well and healthy-minded.

It was also noticeable that the New B IV, even when

largely IV, resembled in moral character Miss Beauchamp more than B IV; that is to say, it seemed as if it was strong, vigorous-minded IV — a character that could be as a whole still recognized as IV — that took on the moral characteristics of Miss Beauchamp, rather than the reverse. It was IV who became amiable and gentle-mannered, and not Miss Beauchamp who became quick-tempered and rude. It was IV who became amenable to control, open-minded, and practical, and not Miss Beauchamp who became hostile and rebellious. It was IV who acquired the points of view of Miss Beauchamp, and not *vice versa*. (A further discussion of the experimental syntheses will be reserved for a future study.)

But what happened to Sally, it will be asked, as a result of all this? From a psychological point of view the effect upon this dissociated personality was not the least interesting result. In the fusion of B I and B IV, Sally, as had been anticipated, tended to become “squeezed,” to disappear, to go back to whence she came. The more complete the fusion and the greater the stability, the more was this the case. At times, when the fusion was most complete, she even lost the power of influencing the “new person,” as she used to call her; and although she still “came” she could not do so voluntarily, but only by accident. She could not by “willing,” or by any of the secret devices which she had invented, change the new person into herself as she could change B I and B IV. In other words, she returned once more to her true function — if she had one, which may be doubted — that of a subconsciousness, her wings clipped, and her powers stripped from her. She was, to all appearances, fused in the new personality.

We had pieced together the débris of personality into a whole; we had sent Sally back to where she belonged. Was this new personality the Real Miss Beauchamp? If so, we had obtained a verification of the hypothesis that

B I and B IV were only quasi-somnambulistic personages, disintegrated portions of the real self. If we accept as criteria of normality, freedom from amnesia, even temperament, stability, health, and absence of suggestibility and of abnormal phenomena, then we may conclude that on a certain number of occasions glimpses of the Real Miss Beauchamp were obtained. Nothing permanent, however, had been accomplished, though if these experiments had been allowed to proceed unhampered, without interference from any of the personalities, and above all, if the personalities could have been induced to co-operate, the problem of disintegrated personality, as far as exemplified by this case, might at this time have been solved, much tribulation and sorrow spared to Miss Beauchamp, and much trouble to myself. But this was not to be. It seemed as if each step forward brought new difficulties.

For the acceptance by the psychologist of much of that which has just been said, the details of the experiments should be studied with all the recorded evidence bearing upon the conclusions arrived at. But inasmuch as at a later period I succeeded in obtaining the Real Miss Beauchamp by another and much more reliable method, which was more certain in its results and produced a much more stable personality, and which besides solved the problem of B II, further evidence will be deferred until the time comes to describe these later experiments. It remains only for the present to narrate the consequences of the experiments which, whatever their success from a psychological point of view, were destined to be ill-fated.

When the new personalities awakened with all the memories of the other selves, everything would have gone well perhaps if each had learned in this way about only her external acts as Miss Beauchamp and as B IV. But each learned more than this. It will be easier to explain what happened if I simplify the complex psychological condi-



tions which resulted from this "putting together" process describing those occasions when the new personality was only B I more or less modified, and those when she was IV similarly changed (that is, not complete).

When Miss Beauchamp became possessed of the memories of IV, they awakened within her a consciousness not only of IV's doings, but of the thoughts, the feelings, and the emotions by which IV had been dominated. (IV from her point of view was, after all, herself.) There surged up within her a consciousness of how she herself, as it seemed to her, had acted and thought; she saw her attitude of mind, her rebelliousness, her anger, her subterfuges, her prevarications, her fibs, her plots to thwart every effort to aid her that was not according to her wishes, her attempts to avoid control, her unyielding determination to carry out her own will,— all this she remembered. It came as a revelation to herself of a part of her life which had so far been hidden from her. It was a blow to her pride and to her self-respect. She remembered her thoughts as IV just as any one of us might remember moments in our lives when we had lost control of ourselves, being for the time perhaps the sport of our emotions, or when, under the influence of circumstances, we had been dominated by thoughts and feelings which ordinarily were foreign to our natures. So the life of IV at such times seemed to the new Miss Beauchamp to be her own past life, but one of change of mood.

More than this, when Miss Beauchamp returned to herself again, reverted completely to B I, she remembered herself as the New B I, and therefore still retained the memory of this revelation. For the first time she, the saint, saw herself in her other character, IV, a character almost the antithesis of herself. She was inexpressibly shocked, humiliated. Unable to look upon it as a mere psychological phenomenon, a freak of consciousness, she insisted upon regarding that other character as herself. "It is my-

self after all," she would say, and yet that other character was so foreign to her own that she felt humiliated and ashamed. On such occasions when, as the result of my suggestions, the memories of herself as IV poured in upon her, a great wave of remorse would overwhelm her. "I am sorry," she would meekly say. "I do not know why I behaved so! Will you forgive me?" She looked upon herself as one who had sinned, and so the revelation brought distress as well as possibilities of health. Even when the personalities were most completely amalgamated, the new person took the same view, although in a more reasonable, self-contained, and less emotional way, for she was in her ideals much like disintegrated Miss Beauchamp.

Something of this is expressed in the following note, written at my request by IV, who remembered the thoughts of the incompletely fused personality. It is an analysis of Miss Beauchamp's thoughts on one occasion when I had made her remember herself as IV. The fusion being incomplete, she was for the most part B I. As one of the results of the experiment, when IV returned to herself she also retained a recollection of her experiences as the New B I, and was therefore able to describe them. The occasion selected is one of the earlier experiments when the first realization of herself as B IV was awakened in Miss Beauchamp.

(The words in parentheses are interpolations to which IV assented to make the matter clearer.)

"I remember everything that happened yesterday afternoon until you tried to hypnotize me. Then, although I did not lose consciousness, I felt as if I were changed — as if I were becoming my old self again. . . . I fought against the feeling and against you. . . ." <sup>1</sup>

<sup>1</sup> In the first attempt B IV was only partly hypnotized, but her eyes closed and she was strongly influenced.

[The letter here gives a brief account of certain specific mental states characteristic of B I, which surged up within IV as she felt herself slipping back, and which caused her to resist. Then repenting, as she saw that I was about to give up the attempt:] "I begged that you would try once more, you remember, and this time I gave myself up entirely. I remember only your saying 'Sleep, sleep,' and then, 'Who are you?' I could hardly answer, 'Miss Beauchamp,'<sup>1</sup> (New B I) I felt so confused. I wondered how I came to be standing there. I had not the slightest recollection of what had gone before. Then, as you questioned me, and I remembered what I had been doing the last day or two (as B IV), I felt ashamed, humiliated, and frightened. I longed to beg your forgiveness, to throw myself at your feet, to do something that would blot out the memory of my sins. . . .

"After leaving your office I felt troubled and distressed. I kept going over and over certain things, trying to find out why I had acted in one way (that is as B I) rather than in another. I kept thinking of you, too, recalling many things in connection with you (for example when I was B I), which I have never (consciously) known (as B IV). They may or may not be true. I cannot (as B IV) say. Yesterday it seemed as if they were. But to-day everything is changed, and, as I told you, I cannot understand now why I should have felt and acted as I did twenty-four hours ago. Yet at the time I was perfectly sincere. I did not realize how very absurd it all was until I had slept and rested and become my normal self again (that is, B IV). You see I could not have been B I.

"April 28, 1900."

When she wrote this note B IV had become herself again and "everything is changed," but she remembered herself as the New B I and it seemed absurd that she ever could have thought and felt like that.

The effect, then, upon Miss Beauchamp of the realization of herself in her other character was humiliation; how was

<sup>1</sup> She had now become the New B I whom I had awakened with remembrance of herself as IV. In the interval between the words "Sleep, sleep" and "Who are you?" she had been B II.

it with B IV, the one whom Miss Beauchamp looked upon as her Mr. Hyde?

As long as IV was fused into the new personality, and even when she was not completely fused but had acquired through my suggestions the memories belonging to B I, she became modified so as to take on more or less of the latter's characteristics; and her sympathies, thoughts, and feelings became practically those of Miss Beauchamp. Along with the awakening of the memory of specific acts in the life of Miss Beauchamp, there was also an awakening of the associated feelings and emotions that had accompanied those acts; and just as the acts—mental and physical—seemed now to have been her own, so did the associated feelings and emotions. All were synthesized with and became a part of her own personal consciousness. Those feelings and those points of view to which she had been a complete stranger a few moments before, now seemed to be remembered as her own, and they continued to be her own points of view and her own characteristics. The two personalities were substantially one, and all was well.

But later, *when she became her old self again*, this self, like Miss Beauchamp, remembered, as I have said, the sort of person she had just been and what she had thought, said, and done; more than this, as the *New B IV* remembered herself as Miss Beauchamp, and as IV retained a memory of the thoughts of the *New B IV*, so IV became possessed in a double fashion of a knowledge of Miss Beauchamp. That is, IV remembered both the character of the New B IV and the New B IV's memories of B I. It was like a mirror reflecting itself in another mirror over and over again. In this way she, our old IV, remembered everything that had happened internally and externally while she was possessed of Miss Beauchamp's memories, *but she remembered it without any revivification of the associated feelings and emotions, just as one would remember a deli-*

*rium of the past.*<sup>1</sup> She went back to herself as IV, retaining only memories of herself during the fused state (limited to a definite period of time), and the amnesia for all else became absolute again.

Now when IV woke to this knowledge of herself in her other character, herself as Miss Beauchamp, her feelings were far from those of humiliation. No repentance or remorse for her! She was made of sterner stuff. She felt only disgust and anger. When she remembered the emotions by which she had been thrilled a moment before, remembered her attitude of mind towards others, and the thoughts by which she had been dominated, she felt only contempt for herself — whether as the new character or as B I, although, as a matter of fact, this new character was identified in her mind both with B I and with herself as she had been in days gone by. They were all, in her eyes, substantially the same. She called the new personality B I. The consciousness that she was the kind of person she saw herself to be aroused within her anger and rebellion. (Indeed it was for this reason that she resisted the first attempt to hypnotize her, referred to above in her letter.) What particularly annoyed her was her passive obedience. To this she constantly referred.

One day after the usual experiment, when B IV had been changed to Miss Beauchamp with newly added memories, I found the following note on my table :

<sup>1</sup> This difference in the synthesis of memories is important for the understanding, psychologically, of character. The various alterations of character which were experimentally induced in B I and B IV showed that a remembrance of the facts of a past event, even when the memory included the associated mental mood, feelings, ideas (points of view), did not result in an alteration of personality. IV might be made to *remember* such events in B I's life without being modified in character. Besides the memory as such, another kind of synthesis, difficult perhaps to explain, was necessary: An alteration of "mood," etc., had to be made. In other words, memory (retrospection) alone is not sufficient to determine personality, which is a mode of reaction of the organism.

"*Don't make me B I*, Dr. Prince. It is giving me all that I most dread."

An explanation of this note came from B IV the next day. In giving it she remonstrated emphatically against being made into Miss Beauchamp. B I, she said, was sensitive, morbidly impressionable, and yielded a passive obedience which she as IV keenly resented. It maddened her to think she was that sort of person. "I feel very strongly about this," she insisted. "It is a very serious matter with me, for I don't want to be that kind of person. Please don't make me B I."

She remembered, too, B I's mortification, including the expressions of contrition with which she had apologized for her conduct as IV. IV saw herself a character whom she despised; and she saw herself repentant for herself as IV — IV who yielded to no one, who demanded to be mistress of herself. Was it any wonder that she resented being changed into such a person? Even before this revelation she had considerable knowledge of herself as Miss Beauchamp (B I), a knowledge gathered from her journal, from the discovery of letters written by Miss Beauchamp (all of which were promptly destroyed before they could be mailed), and from the information furnished by Sally. She also, of course, remembered herself as a girl, as she had been before the accident which disintegrated the original self in 1893. IV even objected to the kind of person she used to be. She had escaped from the chrysalis, and she was n't going back if she could help it. As Cinderella, when the princess' robes were stripped from her, found herself suddenly in rags, so did IV, when her own emotions and thoughts — her own individuality — was stripped from her, find herself in the rags (as she thought) of her other self.

So this revelation which came from the fusion of the two characters only intensified her dislike to becoming

her other self, and her meaning was plain when she wrote, "Don't make me B I! It is giving me all I most dread!"

The following extract from a letter, written by IV, gives a glimpse into the points of view of the different personalities and the way in which the memories were amalgamated: (Enclosed in brackets are explanatory interpolations.)

"All the early part of the morning I remember perfectly up to the time of your hypnotizing me. [From hypnosis as II she was changed to the "new person" (with completely fused character and memories), who later changed to IV, who found me going over some records. As already explained, IV did not remember this preceding period when she was the "new person."] I [B IV] waked [from the "new person"] to find you going over some records. You accused me almost immediately of having changed [that is, from the new person], which, of course, I denied, although I knew I had lost myself. But seeing in your face how useless any such denial was, I acknowledged it (I really had no memory of the time when the new personality was here) and then went on to dispute the account with you, you remember? And then, upon your finding that I could not recall what had happened a few moments before [while she was the "new person"], you again hypnotized me. It must have been very long this second time before I came to myself.<sup>1</sup> When I did I found that I was seated at your desk, reading one of Sally's notes, which I hastily destroyed, thinking that you had only left the room for a minute, and that on your return you would not fail to demand it. But you did not come. After waiting a little, I remembered what you had been going to do [that is, make me remember B I], and thought—rather impatiently, I am afraid—that you had not succeeded very well. But almost with the thought came the memory<sup>2</sup> of myself [as New B I and B I] . . . and, with memory, emotion—that same strange, overpowering emotion of which I told you, which seems to take one's very life,

<sup>1</sup> In the meantime she had been successively B II, the New B I (whose feelings, etc., she afterwards remembered), and finally Sally.

<sup>2</sup> With these specific memories a lot of confused memories of things I don't know about even now.

to sway one irresistibly, — and jumbled memories, confused, of which I knew nothing. It frightened me. I felt again as if I were changing, slipping back, becoming my old self, in spite of my struggling, perhaps because of it. I wrote you that hurried note and left the house. . . . To-day [May 5, 1900] I know that I must have lost myself in that world I told you of [that is, become New B I], so wonderful, where . . . [all is idealism]. Perhaps it's true and perhaps . . .

[P. S.] "I cannot find the 'Story of Teddy Jones'<sup>1</sup> anywhere. You must ask Sally if she has eaten it. . . . Possibly she has repented her indiscretion."

[P. S. by Sally.] "Am I a brick still, Dr. Prince? I don't see why you want all this, for she is n't real, you know. But you may have it. Don't be cross with me. I haven't written to you for ever so long, and I don't talk to you very much.

"S. B."

The discovery by IV of the sort of person she was destined to be, or that she believed she was destined to be, and the realization by Sally that the resurrection of the original Miss Beauchamp meant her own doom, that she would have to "go back to where she came from" and never again have an opportunity to play her pranks, to enjoy her life in her own way, and to do the things she liked, but instead would have to sit inside, "below the threshold of consciousness," dissociated and helpless, forgotten by every one, while Miss Beauchamp read "nasty old books,"<sup>2</sup> did "stupid old things," like going to church and serious work, — these discoveries by IV and Sally, respectively, eventually put an end to all hope of reconstructing the original Miss Beauchamp by the method of suggestion to B II. Both determined that the reconstruction should not be brought about, and both resisted with every means in their power. They threw every obstacle in the way, and

<sup>1</sup> Sally's Autobiography.

<sup>2</sup> Sally's opinion of the serious books of the day.



during the time that the attempt was continued it was one constant struggle against the diplomacy, the secret plotting, and open opposition of the Two. By contrast Miss Beauchamp, the saint, was content to place herself absolutely in my hands; hers was an attitude of perfect faith and confidence, whatever the consequences, whatever the cost. Even though it meant annihilation, she would accept it all. This attitude of self-subordination particularly angered IV, and she would have none of it. The one thing B I could not accept was to be like Sally or IV. This she dreaded, and required constantly to be assured that in becoming her real self it should not be.

To reconstruct the original Miss Beauchamp it was necessary to obtain B II, to whom the suggestions must be given. B IV could make it difficult for me to do this through herself, but could not prevent my getting B II through B I, who offered herself freely for the purpose. To meet this weak point of attack, Sally brought all her influence to bear to prevent my gaining access to B I. The many ways in which the Two could frustrate my efforts and which led to numerous contests with myself will later appear. To take a mild illustration:

One day, not long after these experiments were begun, I unearthed a plot on the part of IV to get away from control, and thus avoid being reconstructed. IV arrived in a belligerent state of mind. She was *not* going to stand this sort of thing any longer, she asserted; she was *not* going to be hypnotized, and she would *not* be made into B II, and so on. Nevertheless, it was evident that she was in a peck of trouble and that she had gotten herself into a mess, from which, as usual, I should have to extricate her. It was always so.

B II was finally obtained, and thereupon gave the whole thing away. B II was very much disturbed by all that had happened and repeatedly begged me not to leave her,

not to let her go her own way, but to protect and control her. Voluntarily she told the story, although frequently interrupting herself and showing qualms of conscience at betraying IV's secrets, which she was loath to reveal. She was torn by two conflicting desires, one coming from IV and the other from B I.

The substance of her story was that IV, desiring to escape reconstruction, had concocted a plot with her friend Anna, by which they were secretly to go off into the country to a house belonging to Anna and there live together, after Mrs. X. (who acted as a sort of guardian friend to Miss Beauchamp) and myself had left town for the summer. Anna had proposed the plan. It was thought that we should thus lose sight of IV and then she would be free of us all. Of course, as was learned, poor B I had come to herself at different times in the midst of the plot just long enough to learn a part of it and to fear the rest. She was trembling for what she supposed she had done, and what she would do, not knowing either clearly. What little she knew corroborated II's statements. Sally confirmed these and later IV herself made a confession.<sup>1</sup>

Sally, in her customary way, was having one of the times of her life, enjoying both the plot and its marring and the discomfiture of the family. Now the simplest way to put a stop to everything of this kind was, first, to reveal the whole to B I and give counter-suggestions to B II. But this was more easily said than done. When I attempted to give the suggestions to II, Sally took a hand in the affair.

"You shall remain B I all the time," was commanded; "you shall never change to B IV." For the purpose of enforcing this suggestion she was directed to repeat it.

"I shall remain B IV all the time," was the way she did it.

<sup>1</sup> Two years later the Real Miss Beauchamp gave me a similar account of the plan.

“No; *B I.*”

“Yes, I said *B IV.*”

“No, you shall stay *B I.*”

“That is what I said — *B IV.*”

She could hear me say only *B IV.* Over and over again I tried to make her hear and say “*B I,*” but in vain. In saying “*IV*” she ran the two numbers together, thus, “four-one,” making them sound like one word, but also as if it was intended that I should hear the word “*one,*” and *B II* the word “*four.*” Of course this was Sally’s doing. *B II* was all unconscious that she did not hear and repeat my suggestion exactly as I had given it. Thus Sally, as she later confessed, circumvented me for the moment. Sally’s confession was accompanied by the usual insistence that Miss Beauchamp should not stay, that she did not like her, but preferred *IV*; and so on.

Thus through plots, counterplots, and interferences these experiments were destined to come to naught, as far as they were aimed at bringing about any permanent restoration of the family to its primitive head; yet they served a valuable end. They showed that a single personality could be created by the fusion of the two personalities, and that as a result of the fusion the subconscious self tended to disappear from sight, that is to say, to become fused with the others, so that all three selves were largely amalgamated into one. This synthesis also demonstrated that the hypothesis which had been tentatively accepted was correct; namely, that Miss Beauchamp and *IV* were only disintegrated groups of conscious states, and that both would eventually have to bid adieu to their friends. Finally, it seemed to have been shown, although not so conclusively, that the new person thus created was the original self, the true Miss Beauchamp, for whom we had been hunting so long.

## CHAPTER XXV

### SOCIAL LIFE IN 1900

IT was now April, 1900. Two years had elapsed since Sally's first appearance, and nearly a year since the birth of B IV in June, 1899. The autumn and winter just past had been occupied chiefly in studying the different personalities, with the results which have been stated. The case was a perfect gold mine of abnormal psychology, and offered a rare opportunity for experimental study. Many studies of this kind were made, and the results I hope to make still further use of at some future time. As one result of these studies we had a fairly accurate conception of the pathology of the case, though the riddle of B II was still unsolved, — who she was and the relation she bore to the other selves, — and we had accomplished little in the permanent synthesis of the disintegrated selves. Progress was slow, but the obstacles were many.

During the last ten months the Beauchamp family had worried through life after a fashion. It had attended lectures in a local college, had performed a certain amount of outside duties, not perhaps very systematically, and had attended to the daily routine of its own life; for, like other families, the Beauchamps required three meals a day, a proper amount of dressmaking, a reasonable amount of household duties, and the maintenance of a certain degree of social intercourse with its friends. Most of Sally's autobiography was written during the winter and spring. This was slow work, subject to many interruptions, and, as we know, it had to be almost entirely rewritten once and

partly rewritten twice. All these duties had to be done, and were done, even if in an eccentric way; the surprising thing is that they were all done without exciting the suspicions of those not in the secret of the case. Miss Beauchamp was known to be a semi-invalid, liable to periodical break-downs,—and that is all that was and is known excepting to a few.<sup>1</sup> Yet the family managed to get on somehow.

The home life was probably the most trying to B I and B IV. To begin with, dressing was a labor. It was apt to mean two or more baths, for IV would never believe she had had one unless she took it herself. This may seem a trivial matter, but what answer was she to make to the other inmates of the house when she was reminded that she had just taken one bath? Then the afternoon bath was likely to be similarly duplicated and similarly commented upon. She did manage to give apparently satisfactory answers and avert suspicion, but it was trying. B I, too, was often in the same predicament. Then, after the bath, came dressing. Suppose it was B I who began, and suppose Sally had not hidden some of the most important articles. When nearly dressed, B IV as likely as not would come and then off would come everything, to be replaced by clothes of B IV's liking, and the hair would be done all over again another way. Lucky it was if B I did not come again before finishing, and all did not have to be done over again for a third time. Then came the family breakfast involving new difficulties; and then the family papers, exercises, and letters had to be found. Where were they? Had Sally destroyed them, or IV, or B I? (for somebody always objected to something) and so on. Before the day began it was three hours' hard work, requiring unending patience and much strength. And so it went on during the day.

<sup>1</sup> The case has, however, been exhibited to several psychologists and physicians.

It is not without interest that about this time B I and B IV both learned to write shorthand and to use the typewriter. Sally can do neither. During the instruction B I and B IV would often change with each other, and of course, each would be oblivious of what had gone before. Yet they managed to become proficient. Sally, when she happened to be present, took no interest in this instruction, and claimed not to pay attention, though she generally sat decorously enough during the lectures. Sometimes she played truant. This knowledge of shorthand became a great help afterwards, enabling B I and B IV to keep notes of engagements and duties, so that when a change of personalities took place either on "coming" could go on with what was in hand. A memorandum was made of every message or task; this enabled either with the help of a few inferences, and, when necessary, a little "fishing," to go on with what she found herself doing. If a letter, it was not difficult, from what had already been written and the memorandum, to finish it. If the clue was insufficient, a note in shorthand to herself would await the change of personality. At times, however, in the absence of a memorandum, no amount of inference or guessing would suffice.

It would seem at first sight to have been impossible for Miss Beauchamp to successfully disguise her infirmity from her friends, and maintain her social relations; but a little consideration will show that although difficult it was not impossible. Both B I and B IV were unusually reticent about themselves, having the faculty of keeping people at a distance and repelling every inquiry into their private life. The former always tried to conceal her anxieties, her depression, and, we may say, her morbid sorrows. The latter did the same for her peculiar troubles, and neither gave away the thoughts which were a part of the moods. Sally was only too anxious to be thought Miss Beauchamp

to disclose the secret of her own existence. While the varying moods, therefore, of the three personalities made Miss Beauchamp appear a "strange, incomprehensible" character, no one suspected that they represented alteration of personality.

As to the amnesia, even this was not as difficult a matter to conceal as would seem at first. The content of our minds is constantly changing from moment to moment; and the number of memories of specific events required at any particular instant to avoid social embarrassment is not large. At any given time of the day we do not keep in mind many of the preceding events of the day; we recall them only when required. When B I or B IV could not do this, an evasive reply, an inference, or a guess would answer the purpose. When the questioner believes that as a matter of course a person is familiar with a specific event, his suspicions are not easily aroused, especially as few people have any knowledge of alterations of personality. I have known a patient with continuous amnesia, *forgetting after an interval of a few minutes everything as fast as it occurred*, to attend the hospital clinic for three months without the loss of memory being suspected by the attending physician.

The chief difficulties lay, not in carrying on her outside life, but in the hostilities of the personalities to one another. IV's determination to manage her life in her own way, even to the arrangement of the furniture in the room and her mode of dress, was one of the great difficulties, and came next to Sally's interference.

It is difficult to describe a typical day, as scarcely two were alike; nor is it easy to state the frequency with which changes of personalities were made, so much depended upon the state of health of B I and B IV, and upon treatment. When the health was bad, when insomnia and anxiety had done their work, the successive transforma-

tions might be a dozen a day; while after treatment, a good night's sleep, and relief from anxiety, Sally might be suppressed for several days, and the changes limited to infrequent alternations of B I and B IV. When treatment was systematically given every day or two, the peaceful periods might be prolonged to one or two weeks. Then, with the relaxation of treatment and the consequent onset of disintegration, would come the outbreak of Sally with all its consequences.

The greatest tranquillity and stability followed the complete fusion of I and IV, and then the resulting "New Miss Beauchamp" would enjoy several days or a week of peaceful life and strength.

The letters of the fused personality showed a mental balance which contrasted strongly with the extravagant points of view of I and IV. Lacking the individuality exhibited by the letters of the other personalities, they are not as interesting in themselves, but are important as evidence.

It will thus be seen that Miss Beauchamp's life was not all trial and tribulation. Through treatment she was given many peaceful days, and often rather long periods of comparative mental and physical health. It was quite interesting to see the transformation that would, almost in a moment, come over her as the result of suggestion. The replacement of neurasthenic symptoms and mental depression by feelings of well-being and mental peace, was instructive. The difficulty was that these results did not last, roughly speaking, over two or three days, and were always liable to be undone by the disintegrating effects of the strain to which her life was continuously subject. It was one of those cases which require freedom from every sort of responsibility and care, material and mental; and yet Miss Beauchamp's circumstances were such that a life of that kind was impossible. Easily fatigued,



she was obliged to continuously exert herself beyond her strength; in need of the assistance of a nurse, or companion, she was required to depend upon herself; mentally fitted only for peace, she was constantly subject to anxiety and fears. Her psychical make-up required that she should be under constant advisory guidance in meeting the every-day demands of her life; but that same make-up prevented her disclosing those demands, and threw her upon her own resources. B I could not by nature voluntarily discuss her private life, and IV would not do so. Thus it was that the effects of treatment were constantly being undone, even long after the Real Miss Beauchamp was obtained by a method which always awakened a definite and the same personality. To keep Miss Beauchamp in comparative stability required constant supervision, exacting more time than it was possible to give. To obtain the relief which always immediately followed treatment meant at this time, and for a long time afterward, a preliminary contest with Sally and IV, generally lasting an hour and sometimes two or three hours. There was a limit, therefore, to the supervision that could be given, and it was practically necessary to leave Miss Beauchamp to a large extent to her own resources until extreme disintegration made interference acceptable as well as obligatory.

What would have happened if the case had not been subjected to this long-continued study and supervision, can only be surmised from the disastrous effects which attended the summer vacations, or Miss Beauchamp's visit to Europe in 1901 under apparently favorable conditions. The strain incident to such experiences when she was thrown on her own mental resources well-nigh undid all good previously accomplished. It is probable that, deprived of continuous supervision, Miss Beauchamp would have ended in some "Salpêtrière;" where, after being reported in the conventional fashion as an instance of "multiple personality," her

case would have been soon forgotten in the list of incurables, as has been the case with so many of her prototypes.

It has already been pointed out that the psychological situation changed soon after IV's advent, in that previously the family difficulties grew out of Sally's efforts to live her own life and to torment B I, while now the wrangling lay almost entirely between IV and Sally. Poor Miss Beauchamp was no longer a factor in the controversy. Sally simply disregarded her as too insignificant to waste time upon. Besides, Miss Beauchamp was "no fun," as Sally often remarked. She would not battle, as would IV, but patiently, religiously, sought to do penance for her sins, the sins of her other selves. In a previous chapter (XIX) all this has been mentioned in a general way, and the social relations of IV and Sally are recognizable in the autobiography. A few specific details and some of the letters will give a better idea of what was going on. IV and Sally had been squabbling all winter, but in the early spring formal war was declared. The ostensible cause was the autobiography; but underlying this was the determination of IV to down Sally, — to "conquer this thing," as she expressed it, and to continue the sole personality and obtain her freedom. "You cannot hold me," she wrote; "nothing can or shall. I want my freedom."

An amusing side of the contest was the strategy with which B IV deceived Sally, not only as to her own character, but as to her tactical intentions and moves. Sally, always gullible, would be taken in time and again, though she affected to despise her adversary. I used to hear the complaints of both sides: Sally, in narrating her troubles, would call IV all manner of names, saying that she had no sense of honor, no moral sense, or anything else. IV was equally intolerant of Sally, who, she declared, was untrustworthy, a child without sense; in fact, nothing but a delirium. Of course they showered each other with letters

and criticisms, written, on Sally's part, sometimes automatically and sometimes in the ordinary way. IV really, in her heart, I think, enjoyed the contest and egged Sally on. She had the advantage, in that she could mutter all sorts of nasty comments about her opponent, who of course heard them but could reply only in writing. If all this had affected only Sally and B IV, it would have been comical enough, for neither of the two possessed feelings to be hurt; but the worst of it was that poor Miss Beauchamp often caught a blow intended for one of the others. For when she awoke she would find letters addressed apparently to herself; at any rate, she accepted them as applicable to herself, holding that after all was said all the personalities were herself. She would wince under the stings and jibes meant for IV, but which she thought were her own self-dissection, and became the unintended football of the other two. Sally resorted to many of the old methods by which she had formerly tormented B I. It was a cat-and-dog life.

One night Sally, to make IV miserable, piled all the furniture, everything movable in the room, upon the bed and then changed herself to IV. But IV foiled her. Instead of putting the room to rights, as Sally imagined she would be obliged to do in order to go to bed, she rolled herself up in a steamer rug and slept on the floor. A huge joke on Sally, IV thought, but it was really on Miss Beauchamp; for, instead of waking up in the morning as IV, she woke as Miss Beauchamp, to whose lot it fell to be the drudge and put all the furniture back in place. The following letters, too, give an insight into the condition of the family relations.

Some one had sent B IV some theatre tickets for one of Ibsen's plays. Sally at the theatre changed IV to B I, who thus saw the play while IV lost it. The following, from Sally to IV, is *à propos* of this victory:

“How awfully clever of you to roast D——, was n't it? But it cost you Ibsen all the same! I don't believe you know what decency is, you bad lot! You're hipped.”

[From Sally to M. P.] “I have decided to send you the other note to-night, for B IV may destroy it if I don't. She has such an ‘onsartain’ temper, and ever since you left this afternoon she's been exercising it on me and on poor B I. She rows us for thinking certain things which are exactly identical with her own unexpressed thoughts. So! Am I to let her do everything just as she chooses? B I won't like it if I do. And am I to send *all* the letters they feel inclined to write? They *are n't* worth reading, really. Please tell me this, and tell me when you are coming back. I miss you awfully now. And whether I may write J. another letter. Don't forget about it.

“B I is buried in the blues. I do hate her just as much as ever.”

[“Thursday, April, 1900.”]

[From Sally to same.] “I know you want me to work more rapidly, and so does B IV, but I really can't do it. Don't be cross with me, will you? I am awfully squeezed, and it makes it hard. The enclosed note is hers. Will you read all she sends me if I turn them over to you? She *can't* be real. C. *never* was horrid like that, — either before Providence or since.

“S. B.”

[From IV to Sally.] “What a very charming mouse,<sup>1</sup> Sally, dear; but don't you know he'd be loads more interesting if you'd give him a tail and whiskers. All well-regulated mice have them. It saves time, you know.

“Amen. Amen. Amen.

“SALLY BEAUCHAMP,

“Aged 49,

“Amen Corner.”

[A postscript to one of IV's letters.] “Sally, dear thing, took four pills last night.<sup>2</sup> You can imagine how affectionately I think of her to-day.”

<sup>1</sup> Referring to the autobiography. “You see what a tiny mouse it is,” Sally had written, in reference to her MS.

<sup>2</sup> Calomel!

[P. S. by Sally.] "Will you forgive me, too, Dr. Prince? Please do, for letting you have this."

[From B IV.] "I cannot come to-morrow. Sally must work here or not at all. But I will give you Friday and Saturday for finishing up the thing. I am so angry with you. I think seriously of getting a waxen image, with pins, etc., and retiring with it into the country. Shall I, or will that, too, be useless? You cannot hold me, Dr. Prince. *Nothing* can or shall. I want my freedom.

"Sincerely,"

[P. S. by Sally.] "This is her own letter, Dr. Prince, really. She did all the revising and abridging herself and tore up the other. I have n't touched it, except to add this. But I'm glad she's unhappy. And she's still fibbing, for I know she is n't cross with you. I think she's the very queerest person I ever saw. *She can't be* real. She could not do and say such extraordinary things if she were. I am so sorry for you.

"S. B."

[From Sally.] "You need n't pay the slightest attention to anything B IV says, or does, or writes. I shall finish the Autobiography if I choose, and I shall say just as much about Mamma and about Jones as I think necessary. You could n't understand it, could you, if I did n't put all that in? And I want you to understand. But I forget that you don't know about B IV's destroying all the last part of what I wrote. She did it because it was about Mamma, and she does n't want me to speak of her at all. She flew into a perfect rage about it, called me 'Shylock' and 'devil,' and everything. But it is true, nevertheless, what I said. I should think she'd be glad to remember that time when she used to be so different, should n't you? But she's not at all.

"About the rest of the Autobiography, Dr. Prince, why must I hurry so with it? You said at first that I could take loads of time if I wanted to, and write it just any way I chose. Now you keep saying, 'Make haste,' and B IV keeps saying, 'Hump yourself, Sally, dear;' and between you I get so squeezed that I cannot write at all. Won't you let me alone, and let me do

it my own way? I'm coming up to-morrow to go on with it, if nothing happens.

"I am simply aching to write B IV. Won't you please, please let me? or at least tell me why she does such odd things if she's real? For instance, you know about her eating — how she's always hungry — yet she has n't been to a single meal since she got out of bed. Not one. I have to go, or else C. And she's like that about everything. I don't understand her.

"You are n't cross with me for writing you all this, are you? I don't mean to vex you, you know, although it is this being good all the time that squeezes me so terribly.

"Hoping you are much better and rested, I am,

"SALLY BEAUCHAMP."

[From B IV, April 23, 1900. I had written on the outside of the envelope of a letter addressed to her, "For IV."]

"DR. PRINCE, — Will you be good enough to address my letters properly."

In April a lull in hostilities allowed the experiments described in the foregoing chapter to be carried on, but the war soon broke out again. Harmony was about as stable as that of the South American Republics, of which one is constantly reminded by the repeated revolutionary outbreaks against the psychic autonomy of Miss Beauchamp.

One day in June, 1900, IV appeared, looking as if she had been dragged through a knot-hole, tired, jaded, and crestfallen. Of course she had been fighting with Sally, and equally of course she had got the worst of it. The consequent insomnia had done its usual part, and her strength had gone. Miss Beauchamp, of course, was in the same condition.<sup>1</sup> Interviews with the various members of the family, including B II, brought out the facts. The

<sup>1</sup> The mental disintegration to which Miss Beauchamp was reduced by troubles of this kind may be seen by her letters which often at such times were incoherent and unfinished (see Appendix N).

statements of each corroborated those of the others. When Sally's turn arrived, she came bouncing into existence, and, evidently expecting a scolding, began to beg off to avoid confession. But a severe scolding and threats of punishment brought her to terms and to a full confession of her sins.

In the first place she had drunk some wine, to which Miss Beauchamp was unaccustomed, and then changing to B I instead of B IV, probably by accident, Miss Beauchamp found herself disagreeably dizzy; or, to call a spade a spade, a wee bit tipsy. Then again, Sally had obtained some morphine and, undertaking to play the part of the friendly physician, had given it to IV for insomnia. As I had previously suggested that morphine should produce nausea, Miss Beauchamp and B IV were going about as if they were passengers on a trans-Atlantic liner. But though Sally's prescription was based on sound medical practice for the purpose for which it was intended, Sally had no such purpose in view. To her mind a peaceful night was not essential; particularly as, if the remainder of the family slept, her own wings would be clipped and her power over the other members of the family would be curtailed. So, partly to counteract the effect of her prescription, and partly to insure proper moral discipline, Sally made a night of it for B IV, and incidentally for B I, who changed with each other. She made them see visions of centipedes and horrible animals running about the bed, and she set up little hobgoblins, grotesque figures who sat upon the bedstead and grinned at them. Miss Beauchamp was so rattled that, as in a delirium, she thought them real; but IV recognized them as hallucinations. Nevertheless IV was frightened, as one is by a nightmare.

Sally did not rest content with this material world, but let her imagination run riot in the realms of the supernatural. She made them see faces and hands at the win-

dow, — not real faces and hands, but ghostly ones. Both B I and B IV were afraid to go to sleep, and lay awake, reading, the whole night, — or such part of it as was left to them in peace. These pranks were carried on not one night, but several; so that little sleep could be obtained.

Automatic writing, too, Sally found effective in hazing. In this she was an adept, as we know. But now she thought it in keeping with her part to imitate the style and manner of the mediums. She found it much more effective, she said, to fail to cross her t's and to dot her i's, and to write in rather a scraggly way as the mediums do. Then there were letters innumerable telling them of things that she thought it would be particularly disagreeable for them to hear.

After a few days of such contests, a night's rest obtained through suggestive treatment would restore IV's shattered nerves; and she would reappear with new courage, reinvigorated, ready for the fray. And so the war went merrily on. All this was nuts to Sally, who enjoyed life hugely. It was the greatest amusement she could have, so long as she could n't lead her own life.

Being out of town during the summer, I saw little of the family, but was kept fairly well informed of events through correspondence, besides being occasionally called to town to set matters right. Miss Beauchamp was at the mercy of the Two. They destroyed her letters and confiscated my letters to her, while Sally continued to write the usual messages to make her believe that I did not want to be bothered with her case any longer. Receiving no answers to her appeals, she believed Sally's tales, and felt herself isolated, helpless, without a soul to whom she could turn. Then Sally, knowing that insomnia and a sparse diet tended to keep the family in a disintegrated condition, systematically prevented their sleeping at night, and kept them from their meals. Miss Beauchamp had a miserable time of it.



Some of the letters received during the summer and autumn (1900) [see Appendix N] give an idea of the situation.

When the experiments were resumed in the autumn, I was again confronted with the opposition of the Two. The members of the opposition were not united among themselves, and their mutual bickerings were still going on. Yet IV, though unwilling to be reconstructed, was dissatisfied with the conditions of her triple existence. She declared her unwillingness to continue this state of things, yet at the same time she was unwilling to be "put together." She was told that if she would co-operate she could be made whole; but co-operation meant the acceptance of all that she bitterly disliked, and to this she declared she would never consent. A true feminine that she was, she wanted to have her cake and to eat it too, — "to be herself," and to be "whole" at the same time.

The result of it all was that for two years it was not possible to continue reconstruction.

[From notebook, *October 5, 1900.* "This was an eventful afternoon, and for the moment threatened disaster to the family. I was giving B II suggestions in the usual way. Finally, when I said, 'You will awake as B I and remember everything that you have done as IV,' I suddenly heard the voice of Sally saying, almost fiercely, 'She sha'n't come, she sha'n't come.' B II was all unconscious of her lips having spoken, nor did she hear the words. A sharp rebuke to Sally at once brought that young incorrigible. In an injured tone she objected to Miss Beauchamp's being allowed to come; she liked IV much better; she did n't want B I; she would n't have her, and so on. Remonstrances, scolding, persuasion had no effect upon this infant subconsciousness; she was angry and rebellious.

"Finally, to end the scene, I authoritatively informed her that B I was to come to me three times a week to be put together. Sally's cup of bitterness ran over. Her answer was a positive refusal to allow it.

"As I was called away at this point, Sally asked permission to remain in my absence, though refusing to give a reason for her request. Something plainly was up. I left her in deep dejected thought. It was transparently clear that she was plotting a new scheme to encompass my defeat, and it remained only to watch developments.

"On my return an hour later, I surprised not Sally but IV, holding two letters in her hand. She was disturbed, angry, resentful. She burst out with reproaches, saying that if I had anything to tell her, any objection to her visits, or any criticism of her conduct, I might at least say it to her face, not write it, and above all say it to her direct and not to Sally. Sally plainly had been at work. Developments were coming. IV handed me one of the letters. It was her answer to a supposed letter of mine and ran as follows":

"DR. PRINCE:

"I have your note and 'prescription' and *prefer* to acknowledge their receipt. It may simplify matters for you to have this in black and white.

"CHRISTINE L. BEAUCHAMP."

The other letter, to which this was her heroic answer, read as follows:

"Will you be kind enough to remain at home unless your presence at my office is especially requested? I have other patients, also other duties, which, unfortunately, require *time*.

"I would suggest your taking a little sense to quiet your senses, hourly, until you are relieved. Nothing more will be needed in your case. Do not answer this."

On the back was written:

"For Miss Beauchamp when she wakes."

B IV was palpably under the delusion that this letter had been written by me.

"'Is that my handwriting?' I asked. She insisted that it was. It was a good half-hour before she could be convinced

that the letter was a forgery, a trick of Sally's, and that it was by a hallucination that she had perceived and even still saw the handwriting as mine. 'I think I know your handwriting,' she haughtily insisted."

The finale of this affair came October 8, three days later; but in the meantime Sally took her revenge for the disclosure of her plot. She wrote IV innumerable letters, each of which was a stab in a sensitive spot; and IV wilted under the attack and showed she felt the sting. When, three days later, suggestions were again given to B II, Sally again objected, speaking at first, as before, as a subconsciousness; and then, coming in person, "I have two bottles of poison," she threatened, "and if you go to X——Y—— [my usual threat in extremities], I shall give it to IV and make her all dead."

Who could tell what a disintegrated personality might not do? And yet I knew Sally's weak spots, and knew she could not be unkind for long, if only those spots were touched. So it came about that under alternate threats and cajoling Sally was soon repentant and submissive, sorry for all; and I soon had before me Miss Beauchamp (B I), whom I had not succeeded in seeing for many weeks. To my surprise, instead of showing pleasure at finding herself present, she became at once painfully apologetic. She expressed regret for having intruded, disclaimed any intention of taking my time, was sorry for having come, and so on. She sought to escape from the room. Her attitude, while dignified, was, to an onlooker, pathetic. She seemed like one who had appealed for life, and to whom help had been refused, one who, against her will, had been made to appear to be forcing her unwelcome presence. As she was leaving the room, I was obliged to take her by the hand and lead her back, a sad, pathetic, but dignified figure. Soon the whole story came out, told by both herself and shortly after by B II, who filled the gaps:

During the previous months she had received letters from Sally saying that I objected to her taking my time, and now she had received a similar letter ; for, it appeared that on October 5th when Sally, left alone in the room, wrote the letter that had made IV so wrathful, she first changed herself to B I, whom she allowed to remain long enough to read it, and then promptly changed B I to IV, whom I found with the letter in her hand. So both had read it. The letter was so addressed that it would do for both.

The difference in the behavior of the three personalities I, II, and IV on receiving the letter was characteristic.

B I did not answer, because she was instructed not to do so ; she was obedient, apologetic, regretful, hurt, cast down.

B IV at once replied defiantly. She was angry and resentful.

B II begged pathetically not to be sent away, that I would help her, protect her from herself, from every one, from Anna, from what I prefer to call "outside influences" which were largely responsible for Sally's conduct.

## CHAPTER XXVI

SALLY SUCCEEDS IN BECOMING CONSCIOUS OF B IV'S  
THOUGHTS, AND IS ASTOUNDED AT WHAT SHE  
LEARNS

ONE day, June 12, 1900, Sally arrived with angels' wings, as it were, fluttering in the breeze. She had turned over a new leaf and was in a saintly mood. She was going, she said, to be always good hereafter, and to do anything and everything that I wished. To prove that she had creased down the leaf, she proceeded to disclose a great and secret discovery she had made, one that she was anxious should not be imparted to B IV. At last she had got hold of IV's thoughts, and her astonishment at the discovery of the latter's real character knew no bounds. To understand the reason for her astonishment it is only necessary to recall that in teasing IV, who always retaliated in kind, Sally could play quite a game. They were like two children tormenting one another from morning till night. But in this game IV had an advantage over her child-like and gullible opponent. As her thoughts were not known to Sally, who, as she believed, was watching<sup>1</sup> her every movement and listening to every word that might give an inkling as to what was going on in her mind, it was easy by a little strategy to hoodwink her "subliminal," and throw her off her track. For this purpose IV used to resort to every kind of artifice that would disguise her real thoughts and keep Sally in the

<sup>1</sup> This phraseology which connotes *continuous* co-conscious activity, expressed IV's attitude and the theory to which she was practically obliged to conform her conduct.

dark. She would throw out a remark for Sally to hear that would be the direct opposite of what she was really thinking. She would show signs of disliking that to which she was strongly attached, and pretend that her feelings were unaffected when she really had to use all her will-power to maintain self-control. She would feign being unmoved by emotion when she was boiling over. She would even feign illness. At first Sally used to swallow it all, bait, hook, and line, so that IV did not find it difficult to make Sally believe that she was a different person in her feelings and tastes from what she really was. She succeeded in making Sally believe that she disliked people whom in reality she liked; that she was devoid of sentiment and emotion which were strong elements in her nature; and in short that her character was very different from what it was. By degrees Sally "got on" to IV's methods and became suspicious, though it took a long time for her to acquire this wisdom.

Sally had often attempted to get hold of IV's thoughts, but without success. At last her efforts were rewarded. By an ingenious artifice, after first "rattling" IV, she penetrated within the secret chamber of her mind, and on several occasions became conscious of what IV was thinking. But—*horribile dictu*—like Bluebeard's wife, after that lady had unlocked the forbidden door, she was astounded by what she learned.

"Why, she is not at all what I thought she was," Sally often said. "She is a terrible person. I never dreamed she was like that." On one occasion, after discovering in IV's thoughts a drastic ultimatum which she threatened to carry out, Sally remarked: "Why, she is a terrible person; she is not at all like B I. She actually does these things. B I would only say that she was 'very sorry'!"

The fact is that Sally was not only frightened but astounded when she found that IV was not in play but in

dead earnest when she fought. It was a game only, just fun for Sally, that meant nothing more than is meant by children's "scrapping" with one another. But now Sally discovered that with IV it was a different sort of thing. She discovered that her other hot-tempered self really was angry and meant to destroy her if she could; that she planned direful things and meant to carry them out, and that she would let nothing, not even her own comfort, stand in the way of accomplishing her ends. To Sally it was a surprise to learn from those thoughts, so long concealed, that when IV threatened to shut herself up in an insane asylum to punish her demon she meant it. Then too the child Sally could not understand why IV pretended not to like persons and things when the reverse was the case, or why she disguised sentiments which were implanted deeply in her nature.

The truth is that Sally was too undeveloped and too unsophisticated to understand that trait in IV which was almost the strongest element in her character, namely, to suppress, to trample on at all costs every emotion and feeling that tended to arouse that idealism and impressionability which belonged to I, and which threatened to place her under the influence of others. Though she had no idealism, yet she had emotions as well as B I, and she felt herself swayed by them at times. If she gave way to them they would rise and overwhelm her as they did B I. "I will be myself," she would exclaim, and so she denied, fought against, and suppressed her own nature. No wonder she was a puzzle and a surprise to a child like Sally.

When at last Sally learned what kind of person she was dealing with, found out that IV meant what she said, and that she would carry out her threats regardless of consequences, whether to herself or any one else, she became actually afraid of her, and did not even dare to let her know that she could discover her thoughts. But it must

not be imagined that Sally after her first success continued to be conscious of IV's thoughts, as she was of Miss Beauchamp's. She could become conscious of them only as a result of an effort of will and of a certain process she had to go through, and then only at certain times when IV was in a perturbed condition of mind, which, however, Sally could encourage by inducing hallucinations. All this must be gone through with every time. So altogether Sally did not often resort to the trick.

The procedure she explained as follows:

If IV is in a sufficiently perturbed condition of mind, Sally proceeds to give her suggestions internally, copying the mode in which I am in the habit of doing it, and using the following three formulae:

(a) You shall stay IV. (Unless this suggestion is given, Sally's knowing IV's thoughts changes IV to I.)

(b) You shall not become hypnotized. (If this is not said IV changes into the half-hypnotic confused condition of B IVa.)

(c) I shall know everything you are thinking.

Sally wrote out an account of the first experiment she made to learn B IV's thoughts. Like most of Sally's accounts it is unfinished (Sally always tired of such tasks before they were completed), but it is sufficiently instructive to be worth giving. It very neatly although apparently unconsciously describes two contemporary streams of consciousness similar to what was described in the autobiography. I also give Sally's letters which preceded and followed her description of the experiment.

"I do hope," she wrote, "this will help you to understand B IV, and please don't fancy that I was unwilling to write it. I *want* to keep my promise, really, yet when you ask me to do certain things, I feel so perfectly sure I cannot do them that there does n't seem to be any use in trying. So in regard to



this, I am not unwilling but unable to make her thought clear to you. And then, too, she is so entirely different from what I fancied her that it is like being brought into contact with another person, almost an entire stranger, as you will see from what I have written. It was her attitude towards J. that you most wanted to know, was n't it? It puzzles me awfully. I can see no reason whatever in the whole thing.

“Yours,

“S. B.

“P. S. Please put it all away” [so that IV will not see it].

[Sally's account of her experiment.] “When C. [B I]<sup>1</sup> left here yesterday she changed to IV at the foot of the stairs and remained IV all the way to the Fens. She seemed much more subdued in her manner than usual, and I kept wondering what she was going to do, for it was late and she ought to have gone directly home. I thought possibly she was going to walk to Brookline to keep the appointment with Anna which she had made. Yet that seemed most unlikely after all that had passed.

“Then I wondered why it was that knowing C.'s thoughts as fully as I do it should be so impossible for me to get at anything in IV's mind, or to understand her motives in doing the very simplest things. We must be connected in some way, I know, else it would be impossible for me to make her see and hear things or to do things against her will. Then I tried, as I have so many times, to get hold of her, repeating, ‘You shall tell me everything, everything —’ but it only changed her to C.; and although I knew everything in her mind then, I knew too that her mind was not IV's mind, so that I really was no wiser than before. Then I made her IV again, and after a minute repeated, ‘You, B IV, shall tell me everything, everything. You cannot help it.’ But, as at first, it only changed her to C., with all C.'s thoughts and feelings. It seemed as if there were really no way for me to reach IV save through B II, and I have always believed that I did not get the true IV then because having all C.'s memories, feelings, etc., she *must* necessarily be modified. I wanted to get her just while she was

<sup>1</sup> As in the autobiography Sally means B I by C. (Christine).

doing and saying some of the erratic things in which she seems to take such delight. I thought if I could do this I could understand her so much better than anything I could get through B II. So I tried again, but started this time in a different way with experiments which I knew from experience would prove successful.

“First, I changed C. to B IV; then I made B IV walk in a different direction, away from Brookline, instead of toward it, as she had been going. Then — she had been walking very rapidly — I made her go more slowly, finally stopping her altogether. She looked around for a minute or two in a puzzled sort of way, then shrugged her shoulders and began to study the shrubbery. When she got tired of this she scolded me — at least I know she meant it for scolding and that she was very angry although she only muttered under her breath phrases like these: ‘So it is you again, Sally dear! I have missed you so! How thoughtful of you to call my attention to the view. The beauty of those clouds, such a misty gray! Who said promises were “sacred,” Sally dear! Bah, we know better!’ etc., etc.

“It does n’t sound exasperating to you, perhaps, but it was awfully exasperating at the time and made me more determined than ever to get hold of her and keep hold of her. After a time we walked on, leaving the Fens by way of Gainsboro Street, and took a car for the — Restaurant, where as you know she has absolutely refused to go for months past. On the way there I made her have two visions, not as I often do by simply willing, but by saying, ‘You, B IV, see a huge toad on the path directly in front of you. You touch him with “Billy” — and she did see it and did apparently push it aside. Again I said, ‘You, B IV, see J. coming. You see him signalling this car. It is *not* a lady. It is J. He sits there in front of you, but you dare not make the slightest sign. Now, he is going — you may . . .’

“She saw him and sat perfectly quiet, doing exactly what I had suggested. After this she left the car, entered the dining-room, and ordered and ate her dinner, although one could see from her impatient manner that she was acting strongly against her will. After dinner she went directly home and took up a

book ('Sartor Resartus') to read. But it did not seem to interest her particularly, for she held it a long time, looking at it without attempting to turn the pages. Finally she threw it from her, exclaiming, 'Not for our sins, but *by* them, Sally dear; thus saith the Fra who knoweth.' Then she began walking up and down, up and down, as C.<sup>1</sup> used to do and as B I does now when she is very much distressed about anything. Not quite like that either, for B IV seemed much more scornful and impatient than distressed, and she stopped occasionally to say things out loud to me about 'The Walrus and the carpenter' and such stuff. I could not see that it had any special significance, and think she did it simply that I might not guess at anything going on in her mind. At length when I got tired of this I tried again to reach her, saying, 'You, B IV, will stay IV. You won't change. You won't become hypnotized, but I shall know everything you are thinking, everything, do you hear?'

"Then it seemed to me (but wrongly) that she became C. immediately, for she was repeating certain verses which I did not suppose B IV ever knew. This was awfully stupid of me, of course, but I did not stop to think at the moment that if it were really B I (C.) her first thought on coming to herself would have been of the difference in her surroundings (that is, between the Fens and her room, and she would not be repeating a poem).<sup>2</sup> I did not think of anything save my own disappointment in losing B IV so quickly. I was discouraged. But suddenly I realized that 'she' had dropped the poem and was talking of me. Not as B I has always thought of me, but in a disdainful sort of way that yet had something of fear in it, which I can only try to express by quoting exactly what seemed to pass through her mind. Her thought when formulated took *very* different shape from C.'s but was perhaps easier to follow —

"She broke off the verses and began to think of me and the past, and the following about me:

[Referring to Sally.] " 'Not know what I think? Not know? How can that be? [Thoughts change to another.] Oh, God have mercy upon me! [Thinking of Sally.] I must throw her

<sup>1</sup> In this sentence C. is used for Miss Beauchamp before the hospital episode.

<sup>2</sup> B I, like B IV, is always a little confused and puzzled on coming to herself.

something, I am forgetting — [Again thinking of another, but quoting] “Never again, never again shall I trust you!” O my love. I see you still, with — [Aloud.] Sally! “If all God’s creatures could be fed,”<sup>1</sup> Sally dear, you know.

“ ‘Devil-ridden that I am — ’”

[Note from Sally.] “I haven’t finished it, as you see, and I’m afraid it’s not very interesting from your point of view, but I want you to keep it away from B IV until to-morrow if you will. She does n’t know that I can tell her thoughts, and I’m afraid she’d better not know it ever, although I should love to tell her. But I won’t; really I won’t.

“S. B.”

The synthesizing of B IV’s consciousness with that of the subconsciousness (Sally) has more of a biographical than scientific interest, as it was not open to experimental corroboration. Sally’s testimony must be judged in connection with the remainder of the phenomena exhibited by this dissociated personality. It has, however, been partially corroborated by the primary consciousness, B IV, who testified that her own vision and thoughts occurred just as described by Sally; so that to this extent Sally’s statement has been verified. The difference in the relations of Sally’s consciousness to B I and B IV opens up some very puzzling problems. Why should the subconsciousness be able to synthesize the thoughts of B I but not those of B IV? To do the latter it became necessary to produce further disintegration. Why? These and similar questions must remain unanswered until we know more about the mechanism of thought. The wide field of logically systematized co-conscious thought, if the introspective account given of it is to be accepted, is perhaps the most important of the phenomena described by the secondary

<sup>1</sup> Quotation from some college nonsense-rhymes.

“If all God’s creatures could be fed,  
The first I’d feed would be Co-ed.”

personality. It is difficult to decide whether this testimony should be accepted as it stands, or whether it requires interpretation. If Sally described the facts as she saw them, was it all a hallucination of memory on her part? But B IV testified to the accuracy of the statements regarding her own thoughts. The co-conscious train of thought involved logical reasoning, perception, and volition of a high order. It was of the same order as much of that recorded in the Autobiography. We know too little of abnormal psychology to reject this evidence off-hand, but before such phenomena can be accepted they should be corroborated by independent observations in other cases. In the records of abnormal psychology there is much that tends to substantiate the claims of Sally; but this is hardly the place to review the evidence, and I shall let the case stand for the present as it is.

## CHAPTER XXVII

### B IV a

IT is now time to describe a new state which developed about this period, and which was at first quite puzzling. This "state," which hardly rose to the level of a personality, is of considerable interest from a psychological point of view on account of the light it helps to throw on the principle of dissociation. In this particular case it became a factor of great importance in practical management, for it acquired an influence which could not be disregarded, but which had to be cajoled, reasoned with, or bullied, according to the exigencies of the moment.

Psychologically, the interest in this state lay in the fact that it demonstrated that B IV could be disintegrated without wholly losing those distinctive qualities which characterized her, just as B I could be disintegrated to become B I a. B IV, we had reason to believe, was but a disintegrated portion of the real self. The integrated elements of this portion now proved to be capable of being still further dissociated, so that there resulted a hypnotic state having its own distinct chains of memories of which B IV had no knowledge. As would be expected, a state of this kind was necessarily unstable, and, as will appear, could be still further disintegrated under the stress of certain psychical excitants.

All this has a distinct bearing on the theory of disintegrated personality, for it is a portion of the evidence which goes to show that there is no limit to the modes and degrees in which personality may be disintegrated, or to

the combinations in which psychical (or cortical) elements may be arranged and rearranged.

One day (December 28, 1900) I was talking with B II when she seemed to slide into a state with which I was familiar, a half-hypnotic state between IV and II, and through which IV very frequently passed before becoming B II. But on this occasion she spontaneously opened her eyes and revealed herself a character different in many ways from anything thus far seen. When questioned she said she was B II, she was B I, she was IV, she was Sally; she was all in one.<sup>1</sup> But on putting her to the test it was found that in reality she had no memory of Sally's life, or of B I's, or of B II's.

At first this state was quite a puzzle to make out, for there was an attitude of aggressive hostility in her make-up which led her to claim to be the other personalities with the evident purpose of defeating the ends which I had in view. It was not clear whether she was B II modified in character, and for some reason much changed in feeling, thought, and even memory, or whether it was one of the other personalities still further disintegrated. As a result of repeated observations, which I may here simply summarize, it was finally determined that she, or "It," was B IV disintegrated, or in a new hypnotic state, and she was accordingly dubbed B IV a. This state differed in every way from B II, both in character and in memories.

As has just been stated, it had been previously observed that when B IV was hypnotized for the purpose of obtaining B II, she used to pass at times into a transitional, or what I called (in comparison with B II) a half-hypnotic condition. I had paid very little attention to it, being chiefly concerned with more deeply hypnotizing her into B II. This state now manifested certain important charac-

<sup>1</sup> These names she had learned partly from having IV's memory and partly from me.

teristics. I shall speak of her memory first. As I said, she used to claim that she was each and all of the others, that she knew all about them; but whenever put to the test it was proved that she knew only B IV, of whom, however, she had a clear knowledge. She never showed any power of recalling any part of the life of the others. Nor did B I or B IV have any knowledge of this state. When too she was wakened she always became at once B IV (never B I) whose memory would be blank for the preceding hour or half-hour. On the other hand, B II knows B IV a, and because of her has often reproached herself deeply. (B II, it will be remembered, also knows B I a.)

In temperament B IV a was individual and characteristic. On a number of occasions she spontaneously opened her eyes, and then her personality seemed to become broadened. She was and is very much like IV from whom all restraint has been removed, and not at all like II. "She is determined," my notes read, "assertive, and difficult to control." It has seemed at times as if this personality represented the deeper, stronger feelings of B IV, those feelings which ordinarily the latter controls, either as a matter of judgment, manners, or expediency, but which in hypnosis become dominant. For instance, B IV has a persistent and deep dislike to being hypnotized, for fear that she may become infected with B I's saintliness, or that she or Sally may reveal some of her own doings, which doings she knows will be disapproved. Frequently, however, she voluntarily requested to be hypnotized for therapeutic purposes, — for the relief of disturbing insomnia or other symptoms. Yet, despite her own request, the moment she entered into hypnosis this B IV a has come to the front and has most rebelliously refused to be "hypnotized" any farther; and it has always been difficult and often impossible to do it. For an hour or more I often labored in vain to



change B IV a into B II, but there were psychical influences at work (not Sally) which were stronger than my suggestions and which I could not fathom. Later the secret leaked out. It was all the consequence of suggestions which B IV systematically gave herself. Over and over during the day she would repeat to herself phrases calculated to act as counter-suggestions when hypnotized and prevent herself being changed to B I, or being changed in character at all. "I shall stay myself; nothing can change me; I shall reveal nothing; I shall be as I am" were some of the suggestions which she would drill into her mind, and even as she was being hypnotized she would mutter these phrases under her breath. As she was told again and again, she wanted to keep her cake and to eat it too. She wanted to regain the memories of all the personalities, to be all-in-one in memory, and at the same time to remain herself in character; to be "put together" and at the same time to remain IV. It was an impossibility, but she contended for it, notwithstanding. Not even to get all her memories could she reconcile herself to the emotional idealism of B I.

Accordingly, when she became IV a her desire to be relieved from some bodily ill sank into the background, and these intense feelings of her nature, rubbed in by self-suggestion, came to the surface and dominated her hypnotic self.

When B II was asked who this new one was she answered, with a comprehensive grasp of the situation, "It is myself," an answer that was puzzling only for the moment.

"Why, then, did you not remember about B I, as you do now?"

"I don't know. I was confused and 'rattled.'"

"Why was your attitude so changed and antagonistic?"

She does not know, but she exclaims, "Why, we are all

the same person — [B] I, IV, and II — all but Sally.” In saying “Sally” she shuddered and recoiled, as if from some dreadful thing.

But IV a is not II either in character or in memory. Besides her own memories she has only those of IV. She is simply IV disintegrated (hypnotized).

As to Sally’s relation to this hypnotic state, Sally did not know her thoughts any more than she knew IV’s, a fact which tended to identify her with a part at least of IV’s consciousness. Sally, indeed, like B II, regarded her as IV, but “rattled,” as she expressed it.

Continued observations demonstrated beyond question that this state is a hypnotic state of IV. Finally, when put upon her honor, she confessed herself to be IV, and later always spoke of herself as IV, never as B I or B II. Whenever IV was hypnotized she passed through this state before becoming B II; and whenever IV a was awakened she became always IV.

This B IV a we have already introduced into our dissociation ring (Chapter XVIII, p. 308). If the real self  $X = B I + B IV$ , as the result of our experiments (Chapter XXIV) rendered highly probable (if it did not prove it), then our ring might be thus constructed :

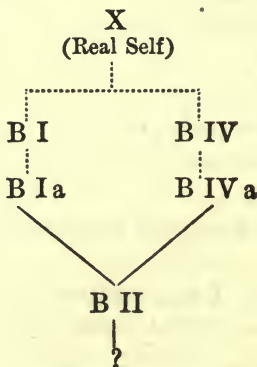

On the other hand, it is by a synthesis that B II is obtained, a synthesis of the hypnotic states B I a and B IV a, or, if we are not entitled to speak so precisely, a synthesis of certain parts of I and IV. As B II was only a hypnotic state the synthesis could not include the whole of I and IV; for if it did we should have, not a hypnotic state, but the real self, supposing that the real self  $(X) = B I + B IV$ . But B II was plainly a hypnotic state, and, strangely enough, on being awakened did not become B I + B IV, but something else.

As just explained, the ideas of IV were strongly retained in this new hypnotic state, and could be impressed therein by auto-suggestion on IV's part. Any attempt on my part to suggest an opposite idea, so far from being accepted, was resisted with all the vehemence possible. This phenomenon is entirely contrary to the popular belief that a hypnotized person will necessarily accept any suggestion given.<sup>1</sup> Suggestions which were objectionable to IV were always refused and fought against with vigór, much to my discomfiture. This resistance to suggestions increased the difficulties of management.

From the psychological point of view and also from that of practical management, it will be readily understood that B II was the key to the situation. Suggestions to B II, putting Sally out of the question, alone would fuse I and IV into one personality, and lacking this, relieve the ailments of both B I and B IV at the same time. It was essential, therefore, to obtain B II. Realizing this, Sally brought all her ingenuity to bear to prevent my obtaining B II. IV did the same, dreading that she would become like B I. As B I was out of the case at this time (for the other two managed to prevent my seeing her, excepting accidentally), there was no way of getting B II excepting

<sup>1</sup> Greenwood (S. P. R. Proceedings) has pointed out the refusal of a hypnotized person to accept objectionable suggestions.

through IV. But IV always changed to B IV a before becoming II. Here lay the difficulty. IV's intense determination and auto-suggestions so affected B IV a that every suggestion to the latter met with counter-suggestions, and, as I have said, even when IV voluntarily asked to be hypnotized, IV a would oppose every suggestion that would change her to II. Feeling her individuality slipping away from her under the influence of the sound of my voice, she would exclaim again and again, "Don't speak to me! Don't speak to me!" as if to escape from the suggestion; or she would directly mutter to herself the opposite of my suggestion, as "I shall go away, I shall stay myself, I shall not change," etc.

When IV a was conquered Sally took a hand. It will be remembered that the more the personalities were disintegrated the more unstable they became and the easier it was for Sally to make use of them for her own ends. So IV a was easy game for Sally, who would produce hallucinations, or aboulia, or deafness, or by one trick or another prevent her changing to B II. And even when B II was obtained the battle was not won. When a suggestion was made to B II objectionable to Sally, the latter at once transformed her to B IV a, or else she produced the same hallucinations, etc., in her that she did in IV a. Sally therefore had to be controlled while subconscious.

I had constantly to invent new devices to control Sally. The effect of pretending to etherize her while subconscious *through B II* has already been described. The same scheme was now worked through B IV a, but Sally soon discovered the pretence, and then I was obliged to use the real article. A light etherization of B IV a combined with suggestion worked in two ways. It reduced B IV a's will-power and resistance so that she accepted suggestions. At the same time it controlled Sally as a subconscious self, and weakened her will-power so that she could neither counter-

act my suggestions by her own, nor influence IV a in one or other of the ways already mentioned. In fact, Sally, as in the experiments of putting B I and B IV together, became "squeezed" and for a time paralyzed. Then B IV a, as she came out of the ether, was easily changed by suggestion to B II. Thus time and again Sally and I had a battle royal in which the stake was the control of B IV a. Though suggestions were resisted with all their will-power and by every sort of ingenious device by IV a and Sally, in the end, by means of a little ether, Sally's will would gradually weaken, her muscles become limp, her opposition cease, the suggestion would be accepted, and victory would perch upon my banner.<sup>1</sup> But the victory did not mean peace. When Sally found that her own existence was at stake, that it was a matter of life or death to herself, she redoubled her energy and soon invented a device to circumvent this form of attack. Unable to fight herself against the inhalation of the ether, she now conceived the idea of making both B IV and B IV a do this and refuse to take it. For this purpose it was necessary to give them a motive. Could she make the process of etherization so painful that IV would resist it with might and main? She recalled how I had produced in herself (Sally) an awful, cold sensation to paralyze her will and control her. If she could make IV suffer as she had suffered, IV would surely fight. She tried the experiment with effect. At the first whiff of ether IV experienced a sensory hallucination in the form of a feeling so horrible that it is difficult to describe. This was accom-

<sup>1</sup> The modus operandi was not wholly the anesthetic effect of the ether on Sally, for later experiments proved that Sally was still conscious and able to signal her presence when the primary personality was well under ether. It was largely through suggestions that Sally was affected by the ether, or, in other words, hypnotized while subconscious. Nevertheless a resort to profounder etherization was effective, when Sally, becoming suspicious, began to test her strength against these ether-suggestions. Later, when I learned to resurrect the Real Miss Beauchamp, to combine all the personalities into one, ether proved a power in my hands.

panied by a sensation of icy coldness and nausea. The nausea alone was bad enough, but the sensory hallucination and the coldness were so awful that IV was unable to endure them. The attempt to etherize her threw her into a hysterical paroxysm in which she screamed aloud and struggled violently. Her teeth chattered with the cold. Etherizing her became a difficult task.

My ingenuity was taxed, but after a time I invented a device by which it was possible to counteract this, so that B IV would consent to take the ether. But now the moment she changed to B IV a she became Sally's tool. With the change the hallucination became doubly intense, and again the struggle would break out. Even when I succeeded in suppressing the sensory hallucination in this hypnotic state, B IV a would still struggle against the ether, throwing the sponge violently from her and refusing to inhale. Even at times when B IV was in a conciliatory mood she was powerless to help, for the effect of her previous auto-suggestions persisted, preventing every attempt to relieve the situation.

Before giving a detailed account of the phenomena exhibited in one of these contests, I will mention an observation of January 16th, 1901, as it gives a fairly good idea of the character of B IV a as contrasted with that of B II. To understand the situation it must be explained that I had known for some time that IV had been scheming once more to get away from my control, though the reason was concealed. She had made overtures to a mutual friend who would, she hoped, take her in charge. Sally was secretly aiding and abetting her in this, for that young scapegrace thought that thereby she would secure her own liberty. So as her share in the plot Sally undertook the part of hoodooing Miss Beauchamp (B I) by making her believe that she had committed some unpardonable fault and was to be sent away. Prevented from seeing me B I

sent the following note, which plainly disclosed the situation:

“If you would but forgive me or let me know in what I have offended! Forgive me, forgive me, dear Dr. Prince, whatever this awful thing that I have done. You must not leave me. To whom could I go! I have only you and I know you will understand! So long you have kept me, — Won't you to the end?” [Here follow four lines erased.]

[P. S. by Sally.] “I only scratched out this little, little bit.

“S. B.”

A few days later B I presented herself for observation, for the first time in many weeks. This was not because she had not tried to come, for she had made many fruitless attempts. Last week indeed she had almost succeeded. She was actually in the waiting-room, but had “come” and “gone” several times, and finally had disappeared before her turn to see me came. Now believing that she was to be sent away she was dejected in mind. Of course she was reassured, but when an attempt was made to change her through B I a to B II, the former hypnotic state suddenly changed to IV a who claimed as usual to be II, but a few simple tests disproved this claim. She was rebellious and aggressive, refusing to accept the suggestion of becoming more deeply hypnotized. Asked why she wished to go away, it came out that IV had been warned by “some one” that I was writing a book about her, and that I had even delivered a paper about her case before the Paris Psychological Congress.<sup>1</sup> Whatever the motive the warning had the effect of playing upon her fears and inducing her to obstruct the work.<sup>2</sup> Dominated by the fear of publicity regarding her life, she wished to seek refuge in flight.

<sup>1</sup> This paper was read before the Congress in the summer of 1900.

<sup>2</sup> An attempt was made also to prejudice Sally against allowing these studies to be made. After a frank explanation on my part, IV expressed herself perfectly willing that any data should be made use of, provided certain private matters were not mentioned.

After learning these facts, I was called out of the room. On my return, I found that IV a had waked up to become IV, who soon spontaneously changed to B I, giving me a chance again to get B II.

[Notebook.] "The contrast between the two hypnotic selves, between II as she sits before me, and IVa as she had been a moment before, is striking. Contrary to IV a, B II begs that she may not be allowed to go, that I will stand by her and protect her. Of her own accord and desire, she enlightens me on matters about which IV and IVa keep me in the dark. Sally, she says, will not allow her to continue as B I. The latter Sally continues to call "a chump," and has caused her to believe herself a nuisance, and that I propose to get rid of her for good and all. B II wants to be B I not IV. As to the publication of her case, I may use any material that I may have in any way that I please. She does not care at all. The difference between the attitude of II and that of IVa toward this and other matters was very marked. It was the spirit of friendly co-operation contrasted with that of rebellious independence."

While II was attempting to explain for my edification some of Sally's reprehensible conduct, she suddenly became dumb. In vain she struggled to speak. Equal to the occasion, I diverted the conversation, and diplomatically spoke in a complimentary way of Sally. Now II could go on again!

One could not help sympathizing with IV in spite of the trouble she had caused. She had been having a hard time of it. She had accepted an invitation to travel in Europe, and B I objected to going. She had planned to get away from my control, and I objected. A—— objected to the autobiography and to my book. She had planned some literary work to be done in the Library, and Sally objected. "Everything," she complained, "is objected to by somebody, and my life is one constant struggle against difficulties."



"I do not quite understand your letter," she wrote. "What I am planning to do is to give three hours every afternoon and two every evening to certain work at the Library, that is, for the next few months, until May. Then Miss K. has asked me to go abroad, to remain until September or October. You will think perhaps that I am risking a great deal, and it may be that I am. Sally objects to the Library work, and B I to the trip abroad. It would be amusing were it not so exasperating, to think of oneself being —"

Here the letter ended. At the bottom Sally had written, "Finished. No more. The end. Your most obedient servant, C. L. B."

Thus for two years, even long after the real self was obtained, it was a constant succession of contests of one kind or another, directed towards relieving the distressing results of disintegration and maintaining a personality with sufficient equilibrium to be fitted to withstand the stress of life. Every opportunity was taken advantage of to fuse the personalities, but each wished to be the one that should live,<sup>1</sup> and each was unwilling to be snuffed out for some one else. B I dreaded to be like IV, IV equally dreaded to be like B I, while Sally loved "herself best of all," and wanted to have at least her share of the time. It was impossible for any one to stay permanently, for each was only a disintegrated self, a part of the whole, and as such necessarily unstable and the sport of the emotions and strains of life. Each, therefore, necessarily changed back and forth with the others.

At times I was on the point of giving up the attempt to cure the case, but so long as the possibility of success remained it seemed that every consideration, psychological and professional, required that we should go on. With what success will be seen.

<sup>1</sup> It was only at a later date that B I was reconciled to her own annihilation.

## CHAPTER XXVIII

### EMOTION AND DISINTEGRATION

WHAT has been said in the last chapter will make comprehensible the motive underlying the following phenomena observed at this time, January 24, 1901. They are in part illustrative of the contests with Sally, but they are described here because they are instructive in that they present an experimental demonstration of the dissociation of the personal consciousness through an emotion, the emotion itself having the effect of producing amnesia, that is, dissociating the memories of past experiences from the personal perception. Secondly, they show the action of a second or extra-consciousness upon the personal consciousness, this action taking the form of a volitional suggestion, similar in every way to one received externally.

The deafness — whether for language only or for all sounds was not definitely determined — is also instructive. That its true interpretation is dissociation and not the total suppression of auditory images is clearly indicated by the fact that the words were remembered by Sally, who, as has been so often pointed out, is at times, at least, a dissociated group of co-conscious states. The auditory impressions were registered, but synthesized alone with this subconsciousness, Sally.

IV was tired and worn out from insomnia. It was not difficult to guess that Sally had been at her old tricks, and had done the family up. For a long time I had been unable to get hold of the little wretch, for her conscience

pricked her, and she was afraid to meet me. I had done my best to wheedle her into coming, but without success. Worn out, IV begged to be made to sleep, but as she could not be carried beyond the stage of B IV a, the experiment of giving suggestions to this character was tried. But again I was foiled. B IV a did not understand a word that was said. She was like a person with word-deafness.

"To-night your eyes will close. You will sleep soundly," were the suggestions given. But it was as if one talked to a person stone deaf.

"Do make me sleep, Dr. Prince. Do make me sleep," she kept pleading, regardless of the suggestion I almost shouted in her ear. I varied the suggestion, emphasizing it in many different forms in the hope that in some shape it would penetrate her understanding. But she was unconscious of my having spoken, or, if she heard my voice, the words carried no meaning to her. It was easy to guess that Sally was at work as usual, but, be as insistent as I would, no impression could be made.

Suddenly her face changed: a wild, frightened expression came over it, and she looked at me with perfect horror. "I hate you, Dr. Prince, I hate you," she said.

"Who are you?" I asked, but she did not know; nor did she know her name or where she was, nor me, though she spoke my name. She shrank from me as if in terror of my touch, and tried to steal past and out of the room. Her mind was plainly in a state of disintegration, retaining only an indistinct consciousness of her surroundings. To every question she vacantly answered, "Yes, yes." After fifteen minutes or so of this she quietly became B IV a, from which she was awakened as B IV.

The psychological interest in these phenomena lies in the relation between Sally's consciousness and the other self, through which relation Sally was able to disintegrate the latter, if we may accept Sally's very precise explana-

tion of how she did it. Of course Sally remembered in a perfectly sane way all the details of the conditions which existed while B IV a was deaf to my words, and later while she was deliriously demented. Sally's memory at least was perfectly sane and without confusion. She remembered *both the delirious acts and the true perceptions of the environment*,—a fact difficult to explain unless some sort of intelligence coexisted with the delirious one.

As to the origin of the emotion and the delirium, she had not, she affirmed, "willed" specifically that B IV a should be frightened, that she should lose her knowledge of my identity and of her surroundings, and should answer "Yes" to every question, etc., etc., but all these things "went together." They were evidently the disintegrated effects of a great emotion which Sally aroused in a curious way.

It turned out that the day before Sally had seen a bird in a cage. The bird was frightened, crouching low, with its wings out-stretched. To Sally's imagination it had a frightened expression and looked like a snake. It occurred to her to make IV a take on this expression, though she "could n't do it exactly," as she explained, "because the bird had wings, you know." She had not directly willed that IV a should be frightened, but she had made her face take an expression of fright like that of the bird, and then all the rest "went together." The muscular expression of fear awoke the emotion, and the emotion induced the "rattling" of IV a's mind, in consequence of which she lost the consciousness of her own personality and of her surroundings. All this was a by-product, so to speak, of the emotion. B IV, to begin with, is a disintegrated personality; B IV a is further disintegrated, but now she became still again disintegrated and changed into a state which may be called B IV b. We had therefore three degrees of disintegration: B IV, B IV a, B IV b. It was an experiment in

disintegration and suggestion, though the experimenter by her own testimony was a "subconscious self." Only the words, "I hate you," were directly uttered by the subconscious personality. These words were put into IV's mouth by Sally.

This disintegrating of the mind by an emotion is of considerable pathological importance, for it throws light upon the genesis of certain pathological states — fear psychoses, hysterical attacks, and certain traumatic neuroses — which occur as the result of railway and other accidents.

Considering the introspective character of the evidence, I would not cite this particular observation in support of the etiology, were it not that the case was full of such incidents, and that grave disintegration in Miss Beauchamp had been frequently observed from time to time as the result of accidental emotional excitement. In fact, it will be remembered that B I and B IV had both developed as personalities out of emotional conditions. On a number of occasions, B I had been seen in a delirious state from this cause, though Sally was perfectly sane;<sup>1</sup> and the sudden development of a neurasthenic condition out of a clear sky under similar circumstances has occurred again and again. I shall have occasion later to speak more fully of the genesis of certain types of neurasthenia upon which these studies seem to me to throw some light. Here I would simply point out the quasi-experimental induction of disintegration by emotion, and the consequences of the same.<sup>2</sup> It is now generally recognized that the pathological condition known as *traumatic neurosis*, which so commonly follows railway accidents and in which every sort of nervous phenomenon may be observed, including disin-

<sup>1</sup> The occasion will be remembered when B I was found in a delirious state and Sally played nurse and cared for her until she was taken to a private hospital. (Chapter VII.)

<sup>2</sup> The case of Marie M., reported by J. M. Boeteau, presented similar phenomena. (*Annales Medico-Psychologique*, January, 1892.)

tegrated personality, is a purely functional condition and is brought about by the psychical and not the physical shock. That it is the emotion of fright which is the genetic factor is not, I think, so clearly recognized. These observations on Miss Beauchamp throw light on the possibilities of emotion in the induction of such disintegrated conditions.

Another point which is of interest is the similarity of Sally's experiment to that of M. Janet.

One of his subjects, Lucie, was thrown into catalepsy; then M. Janet clenched her left hand (she began at once to strike out), and put a pencil in her right hand, and said, "Adrienne (Lucie 3) what are you doing?" The left hand continued to strike, and the face to bear the look of rage, while the right hand wrote, "I am furious." "With whom?" "With F." "Why?" "I don't know, but I am very angry." M. Janet then unclenched the subject's left hand and put it gently to her lips. It began to blow kisses, and the face smiled. "Adrienne, are you still angry?" "No, that's over." "And now?" "Oh! I am happy!" "And Lucie?" "She knows nothing, she is asleep."<sup>1</sup>

M. Janet, like Sally, made use of the muscular sense to induce the corresponding emotion in a disintegrated personality, for Adrienne (or Lucie 3) was not the real self any more than B IV or B IV a was. Just as in the case of Lucie the muscular attitude of the hand aroused the emotions of anger and pleasure, so we must conclude the muscular expression of B IV a's face, induced by Sally, aroused the emotion of fear. In each case the accompanying actions were logical consequences.

Such experiments show the suggestibility of the mind when disintegrated. They also bring out the great number of dissociated states into which an unstable mind may be

<sup>1</sup> From a summary by F. W. H. Myers ("Human Personality").

broken up. These states may be called hypnotic states, if preferred, but it must be plain that hypnosis is nothing more than the dissociation of the personal consciousness, and differs in no way from any state resulting from the disaggregating process. It would be a great advantage if the term *hypnosis* could be dropped, on account of its connotation, and *dissociation*, or some similar expression substituted.

It will be evident that we may now add another radical to our ring, namely, B IV b, as a sort of side chain; B IV b being merely a dissociated state of B IV a, that into which she was thrown by Sally's trick.

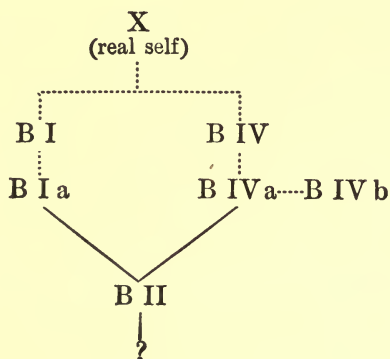

## CHAPTER XXIX

### TYPES OF DISINTEGRATION : MENTAL STRAIN AS A CAUSE

**T**HE relations of the personalities and the hypnotic states to each other must be now sufficiently clear to allow me to point out some additional facts which thus far have been passed over in order not to confuse the problem, though they had to be dealt with in this study. The dissociated states thus far described were not the only states met with. At various times, as a result of emotionally disintegrating circumstances, a number of other states were observed. The state in which B II awoke at the time of the experiment to resurrect the original self was a dissociated state, and might properly be attached in the ring to B II, as B II a (p. 465). Likewise, B I was dissociated into a state with very limited memory groups, hardly knowing where she was or what she was. This might be attached as B I b. Then, again, a state was observed similar to or possibly identical with that described on p. 506 when we had a state in which Miss Beauchamp went back to a period antedating the hospital catastrophe of 1893. The state of which I am speaking developed spontaneously in the following way out of B IV a, and in it the personality imagined that it was the year 1893, and that she was still living in the hospital at Providence:

I had been engaged in an effort (through etherization and suggestion) to convert B IV a, despite her resistance, into B II. Becoming tired of the contest, I left her to herself and went on with my work which had been interrupted. Presently she arose, apparently wide-awake, as if she had changed to one of her regular personalities. But the



difference between her as she then appeared and one of those personalities was puzzling. Her mood was strikingly different from any of the others. She seemed light-hearted and rather girlish, playing with the things in the room and exhibiting a freedom as if she were quite at home. When I remonstrated she answered that she should do as she pleased, and should turn everything topsy-turvy if she wanted to, straightway proceeding to do it with some of the articles on the table, although rather in jest. Her answers to my questions were so irrelevant that the first thought was that one of the personalities, probably Sally, was playing a part. It was some time before the real fact was realized, namely, that this personality thought the time was that when she was in the hospital at Providence, ten years before; she thought she was in that town; mistook me for J. and conversed familiarly, asking all sorts of questions about what I was doing, etc. She did not know me or my name, for of course she had not heard it until many years later; nor did she know Mrs. X., or many other persons whose acquaintance she had made since. She spoke by name of the doctors connected with the hospital, and of herself as belonging to it; presently remarking that she must go home (to the hospital), as she must be in by nine o'clock, etc., etc. All her memories, however, were not well associated or clearly defined, for she could not state the name of the hospital or the name of the town. But in some other respects her memories were quite clear.

Examination showed that she was in what seemed like a somnambulistic condition, and that she was very susceptible to suggestion, for it was easy to make her believe that a medical percussion hammer was a rabbit or a dog; that her hat, which she was putting on, was a pillow; that the door was locked, etc. Still she exhibited marked spontaneity, and seemed a well-rounded personality.

One interesting phenomenon was her failure to recognize

an automobile. Her attention was attracted by the noise of several automobiles in the street, and she exhibited a lively interest in them. But she did not know what they were, as of course in her Providence days there were none in use in the neighborhood

She was easily hypnotized, in the sense that her eyelids closed at a suggestion; then she suddenly changed to B IV, who of course, had no memory of what had just taken place. B IV shortly changed again, suddenly and spontaneously, to this somnambulistic state. (The change was plainly occasioned by the anxious thoughts which filled her mind.) Later, I changed once more this somnambulist to IV, who left the house. As I bade her good-by on the front steps she turned and made a remark which was characteristic of and belonged to the memories of the somnambulistic person. It was evident, therefore, that she had changed again. It was late at night, and, if she was in the somnambulistic condition and imagined herself in Providence, she would probably go wandering about in search of the hospital. In imagination, I saw her, at the end of her wanderings, the subject of the headlines of the newspapers the next morning. Here, too, was a chance not to be lost to test the bona fide character of the phenomenon. I let her go, but after she had disappeared in the darkness I followed on a bicycle, overtaking her several blocks away. I kept well behind until it was plainly evident that she was unaware of her whereabouts. I then surprised her, and found that she was still in this somnambulistic state. It took but a moment to hypnotize her on the street and change her back to B II, who was found to have a complete knowledge of herself as the somnambulistic person. As II she gave a full account of the matter, explaining that her memories were all jumbled up (confirming what had been observed), and attributing the whole to the great fatigue and strain under which she was laboring.

It is interesting to note that B II, a synthesis which included B I a and B IV a, combined in herself the memories of this somnambulistic state, and recognized them as a delirium. She did not regard this state as a different person, as Sally would, but felt only that she herself at that time was in a peculiar condition, just as one might remember a dream or delirium.

This new state, which may be termed B IV c, if one likes, developed as the consequence of great fatigue and mental strain. It was temporary only, and ceased with the cessation of the cause. This somnambulistic state is analogous to one in the patient M—1, a Russian (already several times referred to), who, in hypnosis, went back five years in his life to a period when he was living in Russia. He could then speak only the dialect of his native town, having lost all knowledge of English, which he spoke well when awake.<sup>1</sup>

The states thus far enumerated are not all the different states that were observed, one differing from another in the groups of memories remaining synthesized in the personal consciousness. These states were ephemeral and easily transformed into the major personalities.

We might here with propriety attach various side chains to our ring. Thus:

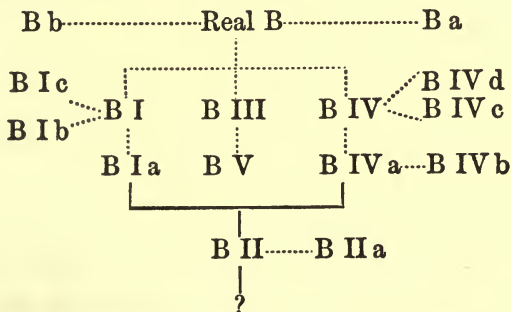

<sup>1</sup> Boston Medical and Surgical Journal, June 23, 1904.

This attachment of these secondary states as side chains to other disintegrated states is schematic and somewhat arbitrary, as the relationship cannot always be demonstrated. It would perhaps be more logical to attach them to Real B as disintegrated descendants in a sort of genealogical tree. Thus:

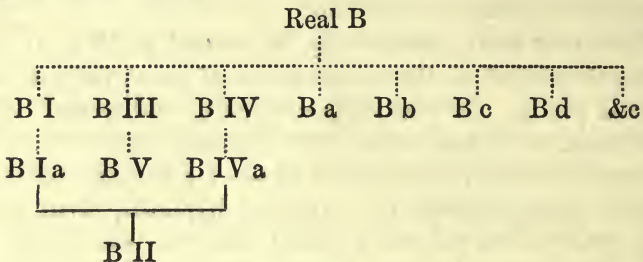

The fact that B IV a could be still further disintegrated into other states with altered memories became a matter of more than psychological interest. It assumed practical importance, for under the mental strain that the family was about this time undergoing, B IV a developed a tendency to change into such a state and thus evolve another personality with a new set of memories. It came about under the following circumstances, which are not without interest if we would understand the genesis of disintegration. They show the influence of *mental strain* in loosening the bonds of normal associations and thereby permitting abnormal phenomena, including new syntheses. We have already seen an example of the effect of this influence in B IV c; about this time, January, 1901, I had an opportunity to observe the creation of another type, B IV d, as well as to witness a fine example of aboulia. The mental strain grew partly out of the fact that not one of the personalities was satisfied to do what the others wanted, each being thrown into a state of mind which became, if either of the other two was allowed to have

her own way, resentment on the part of B IV, depression and unhappiness on the part of B I, and boredom on the part of Sally. Consequently, Sally and B IV were quarrelling, while, as usual under such circumstances, B I was made to believe that she was to be cast overboard and left to drift by herself. She had written me letter after letter without receiving an answer, and had tried in vain to see me personally. Of course no letter had reached my hands.

The following from IV, written at the beginning of the trouble,<sup>1</sup> gives only a faint insight into the nervous strain she was soon to labor under:

“. . . I really meant all that I said on Wednesday — meant it for a day and a night. Then Thursday I lost myself, recovering to find that it was twelve-thirty, that I had not been to the office, that I had neglected several other important things, and that I had written out a minute analysis of an experience which I would not have had any one know about for worlds. Again I lost myself; again recovered; I was walking rapidly through Marlborough Street (Where?); talking with some one at the P. O. (Whom?); fencing with one and another here at home —

“Can you not understand how great the nervous strain involved in keeping up with all these changes might be? Can you not understand how much I would have given then for help? Thursday night I slept badly, lost all the first part of Friday morning, and finally came to myself to find — regarding me most intently. He was talking. I knew that in a minute — a second — he would require an answer. Who was I? Sally or B I? And what on earth was he discussing?

“So it has been all through all the hours since Wednesday, each change rendering me more nervous, more irritable, less able to meet the demands made upon me. Forgive me for writing you all this. I do it not to excuse my childishness, but

<sup>1</sup> When she was in a tractable mood, and agreed to co-operate, to submit herself to experimentation, etc.

that you may perhaps better understand my attitude toward you to-day. Do not consider that hour as isolated. Think of it as having been affected by all that has happened since Wednesday. If you knew all, I do think you would forgive me. It is really the multitude of little happenings too trivial for you to record, which very largely make me what I am, 'an idiot.'

Then again not only B IV had been harrowed by outside influences about the publication of these studies, but even the imperturbable Sally had been worked upon, and became so disturbed at the consequences which were suggested to her that even she showed a tendency to disintegration. "Somebody" had again become a disturbing factor in the case. B IV again rebelled against control and tried to escape, while at the same time B II begged for help. My patience was indeed tried by what seemed unnecessary and uncalled-for interference by "Somebody." Danger threatened, too, in another direction, for Sally had shown an unaccountable anxiety to recover possession of the manuscript of her autobiography. "I want you to leave the manuscript out for me," she wrote, "Please, every bit of it. I'm terribly in earnest."

And again:

"... All I care for is my precious manuscript, which I beg you will return to me, only for twenty-four hours, then you may have it all again. I will be reasonable. I will indeed, but it is hard to refrain from 'My daughter! Oh my daughter!' And it's so much easier making promises and getting into scrapes than fulfilling them and getting out again."

This incident might be passed by were it not that it not only was mixed up with further outside interferences which were the cause of mental strain to B IV, but it furnished the motive, as may be seen from the above letters, for the following manifestations of aboulia. It was an exhibition

of as beautiful examples of this phenomenon as one could wish to see. By this means Sally prevented B I and B IV from handing over the pages of the manuscript which were in their possession.

Sally, after finishing the pages of the manuscript that were the task of the day, had hidden them in her dress, with the intention of carrying them off surreptitiously. While I was remonstrating with her she suddenly changed to B I, who, hearing the last few words of the scolding Sally was receiving, and thinking it was meant for herself, earnestly expressed herself as perfectly willing to help in every way in her power. As a test I asked her to give me the autobiography which Sally had just hidden. At once her whole manner changed; her face took on a gloomy and vacant expression, and she kept repeating, in a stereotyped way the words, "I don't want to give it to you, I don't want you to have it." She was then hypnotized and changed to B II, who began to assure me that she wished to do anything I wished her to do; but there was something in her, she did not know what it was, that made her use those expressions, "I don't want you to have it," etc. It was the same thing that constantly made her say and do things that she did not want to say or do. Later, after several changes of personality, B IV appeared. The same test was made with her as with B I to see if she could give me the hidden autobiography. She expressed a strong desire that I should have it; said that she was afraid to trust herself with it at home, and wanted to give it to me, but when I made the demand that she should hand it to me she would not make more than a superficial effort to find it. She tried in a half-hearted, hesitating, feeble way to find it by feeling through her dress, but without success. I assured her that the autobiography was hidden on her person, and explained the situation, stimulating her ambition not to be beaten by Sally. She remonstrated warmly

against the interference of that personality, but when urged to hand over the manuscript she was unable to make the effort, and only gave excuses for not making a thorough search. It was evident that something was preventing her from exerting her will-power, as it had B I, but in a somewhat different way, to obtain possession of the manuscript. She was left alone in the room to make a thorough search, but it was without avail. There was no doubt that both B I and B IV desired to obtain the manuscript, and to hand it over, but they could not *will* to hunt for it. Later, Sally, in a penitent mood, explained how she produced this aboulia. She had not directly willed that IV and B I should not search for the manuscript, but she had "wanted" them not to do so. Her subconscious thoughts and feelings had involuntarily affected the primary consciousness. The words that B I spoke were, of course, "automatic speech," and were uttered by Sally.

Under the wear and tear of all this mental strain both B IV and B I got into a highly unstable condition, and an opportunity was soon offered of observing further disintegration.

Before describing what occurred it may not be without interest to recall the case of Marie M., reported by Dr. J. M. Boeteau, and mentioned in the footnote to page 459. The similarity of the phenomena manifested by Marie M. with those which now developed in B IV is instructive.

This young woman, Marie M., was greatly shocked by being told that she must undergo a surgical operation. Still under the influence of this nervous shock she left the hospital of Andral in Paris at 10 o'clock in the morning, but remembered nothing more until she awoke three days later to find herself in another hospital in the same city. She had been found, on the evening of the day on which she left the hospital, wandering around the streets of



Paris in a condition of maniacal excitement, with haggard aspect, worn-out boots, and lacerated feet. It transpired that under the influence of a delusion in regard to her baby, which she imagined was being kept from her, she had walked to Chaville, then on to Versailles, and back to Paris. On coming to herself she had absolutely no recollection of these three days. *On being hypnotized* by M. Boeteau, she passed into a state in which she remembered the events of this period, including both her wanderings and her delusions, which were at first connected with her baby, but later included spectral surgeons who endeavored to perform operations upon her.

The noteworthy points in this case are the condition of mental disintegration into which this young woman was thrown by a powerful emotion and the recollection of the disordered mentation by the hypnotic self.

So, in the case of the state into which B IV changed, both Sally and B II could recall afterwards the wanderings and the delirium of the disintegrated personality, but there was this difference: *II recalled the delirium as her own*, while Sally recalled it as that of another person, for she remembered also the true perceptions and cognition of the environment which she believed to be her own. The thing happened in this wise:

One day after vainly attempting to change B IV a into B II I left the former half asleep, so to speak, thinking she would wake up spontaneously as B I or IV. But two hours later I found awaiting my return neither of those personalities, but another, who, though she knew me, did not seem to know herself. She could not tell who she was or where she lived. Her eyes were open, and she was docile and willing to follow directions. While I was engaged in telephoning she left the house before it was possible to stop her. In the evening the following note from Sally arrived:

"Won't you please come or send Dicky to-night? I can't do anything myself and am so afraid she'll go wandering off again. She's been out all the afternoon. I think you did n't quite wake her up, or something. Please help.

"SALLY.

"I don't know what to do alone. Anna is n't any good when things are serious, for they dislike her too much."

Sally I found in bed, at last anxious and disturbed over the condition into which she had helped to bring the family. It appeared that after leaving my office this "New" person had taken a street-car to Cambridge. It was midwinter and a blizzard had been raging all the afternoon, and in this blizzard "she" had walked about in a semi-delirious way for several miles. "She" had become wet and cold and had had several chills alternating with hot flushes. Sally was plainly alarmed for fear "she," the "new one," was going to be ill, *though Sally herself felt perfectly well*. Sally was afraid "she" would go out of the house again in the blizzard, as "she" had already made several attempts to do. So finding herself unable to influence her, or even to come herself of her own accord, Sally had circumvented her by taking off her own clothes, hiding them, and popping into bed. When the "new one," with whom Sally had been *spontaneously* alternating, found herself without clothes she plainly had to remain.

This state might be called B IV d, or, if it is preferred, Ba (a disintegrated part of the real self). Sally, penitent, helped to bring IV, who, after a good night's sleep awoke, feeling banged and battered and bruised, but no longer desirous of getting away from control.

[Letter from Sally, penitent:] — "I'm coming up to-morrow morning instead of in the afternoon. I'd rather, and I know you won't care. It was n't wholly because of — that

IV went wandering, and she didn't confine her wandering to Cambridge. Did you write it down so? I was afraid to tell you all about it—afraid you'd scold me, but I'd rather be scolded, I think, than have you look as sorry and troubled as you did to-day. . . . And I think understanding things perfectly, even though they may be very bad, is better than being puzzled and in the dark. Only it's hard telling you, for if other people are concerned they are n't willing to have me. And I myself am not *very* willing, for I know I do a great many things that you would not approve and I do not like to tell about them afterward. B I has been writing you this evening about a dozen letters, but as none of them are finished I know you won't want them. She's awfully distressed and fancies that you are trying to get rid of her and wants to go and dares not. From her thoughts she is mixed up with IV in a curious way. . . .

“Tuesday. Please save this for me.”

But the effects of the mental strain were not over yet. A day or two later another opportunity was afforded to study this new person into whom B IV a had changed on opening her eyes. She proved to be quite a distinct personality, so much so that I was disposed to name her B VII. Her mental life was extremely contracted, being limited practically to the experiences which she had already had during the few times that she had been in existence.

She had no memory of the lives of B I, B II, B IV or Sally. She could not tell me a single thing that any one of them had done or said, but she recalled her own doings; for instance, those on the day she went to Cambridge in the blizzard. She knew me, in a limited way. Her mode of speech, attitude, and manner were individual and characteristic. She was plainly a disintegrated field of consciousness. But it is highly probable that if her experiences had been frequently multiplied we could have obtained a personality quite as individual as IV. But

this, of course, was discouraged and every effort made to prevent her development. In this, fortunately, I was successful, and her experiences after this were very few and short-lived.

Psychologically, all these states are interesting, for as *spontaneous* phenomena they bear out the experiments of Gurney (already alluded to), who was the first to show that there is no definite particular hypnotic self for each individual, but that a sensitive subject may be successively thrown into a series of "states," each with its own separate groups of memories. He thus obtained three distinct states in the same subject. Mrs. Sedgwick and Miss Thompson afterwards obtained eight.<sup>1</sup>

Such states represent minor or undeveloped forms of personalities. They depend on the one hand upon the dissociation of the normal personal consciousness by which certain memories and perceptions are lost, and on the other, on a rearrangement or new synthesis of the psychical factors (memories, moods, etc.) which make up personality. The new synthesis may have a very limited field of consciousness, differing from the original personality rather by what it has lost than by what it has gained. It may have very little spontaneity and power to originate action, and so far as its memories and mental reactions persist they may show little variation from the personality out of which it has been formed. Such a synthesis is conveniently spoken of as a "*state*," whether so-called "hypnotic" or not.

When the new synthesis is complex and embraces a

<sup>1</sup> Since this study was written Dr. Albert Wilson has reported a case exhibiting ten personalities besides the normal self. Each abnormal personality exhibited a very much disintegrated mind with limited faculties. (S. P. R. Proceedings, Oct., 1904). The various sub-states obtained in Miss Beauchamp's case correspond very well with those of Dr. Wilson's case, and if I had allowed them to remain and develop we might have had as many personalities, but with similarly restricted fields of consciousness.

wide field of consciousness, we have what to all intents and purposes is a complete personality. It may have its own groups of memories, with amnesia for the original personal synthesis, and its own peculiar reactions to the environment (moods), thus differing in memory and moods from the original self. It is conveniently termed a second or third personality.

Theoretically, a normal personal consciousness may be disintegrated in all sorts of ways, so that any group of memories, and even functions and faculties, may be lost; and all sorts of combinations of memories, functions, and faculties may be formed. Practically, we find that what is theoretically possible actually takes place, and thus it happened that in the case of Miss Beauchamp, new personalities or new hypnotic states could be formed out of each of the others.

The difference between the psychological relations of Sally and those of B I and B IV, to these disintegrated states should not be overlooked. The two latter had no knowledge of B IV d, for instance, while Sally not only knew all about her but, as a *sane* personality alternated with this *delirious* one. Everything indicated too that true perceptions and recognition of the environment did occur, as dissociated states, coincidently with and subconsciously to the delirium, for Sally remembered them and believed at least that they were her own.

## CHAPTER XXX

### A CONTEST BETWEEN PERSONALITIES

THE spring of 1901 will live in the annals of the Beauchamp family as a critical period for its peace and happiness. It saw a feud which was intended to be a life or death struggle, a fight to a finish, between IV and Sally. One or the other, so the manifesto issued by the former read, must be mistress; or rather, "Carthage must be destroyed." Sally must go. The clouds had been gathering for some time, as far back as February. IV had issued another ultimatum and a threatening letter which IV planned to send to Anna, to get rid of that person's interference. Sally happened to have a fit of penitence, as far as I was concerned, and so I was treated to the following epistle:

"Shall I write about Miss K. and Anna and all the things that occurred when C. first came to Boston?<sup>1</sup> B IV does n't know about them yet and I'm sure will deny the truth of whatever I may say, for she likes Miss K., and is entirely mistaken about the way in which Anna came into her life. She has false impressions about so many things! and is so conceited and so stuffy that she will accept neither correction nor suggestion from me. She is willing enough to snatch at the faintest hint from other people, and to infer from every such hint that she, as B I, has said and done certain things. She is an idiot, and this I know positively since I have known her thoughts.

"Shall I ignore all this and go on as if she were in possession of the real facts? I don't wish to if it is going to make her angry and lead her to form more schemes for squeezing me. I'm sufficiently squeezed now, thanks to her abominable temper.

<sup>1</sup> For the Autobiography.

“Don’t let her send any such letters as the enclosed to Anna. She is going to submit whatever she writes to your inspection, and you can criticise it then. [B] I wouldn’t like it, *really*, for she’s never rude to people and she does n’t dislike Anna half as intensely as IV does, and she does n’t wish to hurt — .

“Very, very sincerely,

“S. B.

“Why may I not write you now? You said long ago I might write every day if I chose, and even that you wished me to do so. Is it different now? Are you too tired to read letters? You are n’t old yet. Perhaps I will go to Dicky if it’s better. I would rather go than have you always tired and troubled.

“S. B.”

The protocol of B IV’s ultimatum to Sally [Feb., 1901] ran as follows:

“No communication whatever with J. or Anna.

“No interference with mail.

“No letters to Dr. Prince or to myself ; except, in the case of myself, when they may be absolutely necessary to give information.

“No more snakes, toads, spiders, and such absurdities.

“No more hallucinations, whether of sight, touch, or hearing.

“No more nonsense concerning Dr. Prince.

“Also she must not receive or spend any money beyond a fixed weekly allowance which I shall give her—she to keep it separately and spend it as she may choose.

“She must not destroy any of my notes or interfere in any way with the work I may choose to do.

“She must finish the autobiography immediately, confining herself as far as possible to personal experience, and leaving out all that concerns other people.

“She must allow me to choose my own friends, and to determine for myself what I shall eat, drink, and wear, as well as where I shall stay.”

If Sally did not accept and abide by the terms of this protocol then B IV was to resort to extreme measures,—an asylum if need be. One great grievance of which IV complained was Sally's choice of friends. These people were very objectionable to her. "I must be allowed to choose my own friends," she insisted. How could she if Sally was free to hob-nob with anybody? On waking up (that is, coming to herself) she found herself constantly and unexpectedly in friendly relations with people whose personality was distasteful, and in situations where she was obliged to play parts foreign to her own character. For instance, there was some friend of somebody's—to be sure she did not know positively whether of Sally or B I (but presumably of Sally)—named Miss Lamartine, a French woman, whom she seemed to see very frequently. This woman's personality and foreign point of view were distasteful to IV. Then there were two art students, girls, whom she knew very slightly, but with whom Sally was on intimate terms. She disliked their attitude towards her. They expected her to be always amusing, in high spirits, gay, and frivolous,—ways which were not natural to her own disposition. She could not play that part, and when she came to herself and found herself talking with them, they, seeing the sudden transformation in her manner, of course thought her moody, strange, and changeable. They treated her as one much younger than themselves, whereas she is really older.

Then, equally uncomfortable were the occasions when others, like the Rev. Mr. C., who knew her only as Miss Beauchamp, spoke to her and treated her as morbidly conscientious and unhappy; whereas, she, B IV, is not so at all, and finds it difficult to live up to any such lofty part. In fact, she can not attain to the high ideals of Miss Beauchamp. She finds it as difficult to live up to the standard of this other self as to come down to the



standard of Sally. Then Miss Beauchamp's friends bored her as much as Sally's offended her. B I had a lot of old lady friends whom she liked to visit and to whom she was very kind. They were "awfully stupid, and bored" B IV. To wake up and find yourself obliged to be pleasant and friendly to such people is a terrible trial, she complained. And so it went on.

I listened to B IV's tale of woe as she unburdened herself and earnestly insisted on something being done, but it was easier to threaten and insist than to do. Sally in turn told her side of the story — all penitence now gone in a twinkling — and defiantly proclaimed what she was going to do. As to her friends, they were great fun. She was going, too, to have an allowance to spend as she pleased; whether or not IV paid her bills was no concern of hers. They were not her bills, but IV's, and she had no responsibility for them. One thing she was going to do and that was to spend all the money she pleased.

The war clouds were gathering thick and fast. Letters of complaint poured in upon me. It was difficult to understand the meaning of many of them, for they referred to fictitious stories which Sally invented, often at my expense, to annoy both IV and B I.

"If you really," IV wrote, "have such power over Sally as you claim, I think it positively wicked of you not to make a different and better use of it. You know so well the utter worthlessness of all her promises, yet in exacting fresh ones you seem to think you have done all that is necessary in order that I may 'go in peace.' It is not so. Weeks and weeks ago I *begged* that you would help me about certain things. Yes, you would; you would see Sally at once. You saw her, explained, received her promise, and — things went exactly as they had gone before. I waited — a long time it seemed. Then I appealed to you again. Again your promise; again Sally's; and again — nothing. This is the last time. I shall not ask you again, but for this once let there be perfect frankness

between us. If it is my attitude towards you that renders you unwilling to help me, tell me so. If it is something else, lack of comprehension, or real inability, or weariness, I would know, I *must* know."

B I also became troubled by Sally's inventions, as indicated by the following letter. The contrast between the two letters is psychologically interesting.

"I saw you for so brief a moment at the last that I cannot be sure 'all is well.' This latest phase of Sally's development troubles me exceedingly. It *must* come from something J. or Anna has said to her, for she has been loyal enough hitherto. And if it is from them and is accepted so credulously, is there not danger of her repeating it? Who can say! It would kill me, or worse. The very thought makes me suffer. Do what you can to curb her unruly tongue. It is all so mysterious, so puzzling, that I dare not make any suggestion. I leave it all to you, asking only your forgiveness for the past, your faith for the days to come. I shall need it!

"Pardon! I cannot rewrite, although Sally has spoiled this. It is very late."

As would be expected, all this harrowing brought on the old nervous symptoms, and then Sally, at last helpless and brought to her knees, wrote for assistance.

"Will you come some time to-day if you can? Give IV the enclosed note *without any explanation* if she's inclined to be nasty about answering questions. If she is n't and does what you tell her, please destroy it here and put it in my basket, — because I want you to. She will do anything you say without reservation then. *Please come.*

"I can't dress or I would come to you. I will be good.

"They are sick, that is why I want you."

B IV's dread of being in the streets at night still further worked upon her nerves. To be out at such times scared her blue, while, curiously enough, neither B I nor Sally

had the slightest fear. This gave Sally a chance which she could not resist taking advantage of. So it happened that night after night IV would suddenly awaken to find herself alone in the streets of the city. Terrified, she would hurry home as fast as her feet could carry her.

"I am too nervous and excited," she wrote, after returning from a nightly peregrination, "to attempt to write you at any length to-night ([interlineation by Sally] 'Nobody asked you, Sir, she said.') This going out in the evening, however coolly B I and Sally may take it, does not agree with me in the least. I have never been accustomed to it and never shall be.

"I want to tell you that there is no reason why I should not be perfectly frank with you *now*. That I still evade and shrink from answering your questions must be due in some way to Sally's influence. I want to tell you."

[P. S. by Sally.] "I waited and she did not come, called and she did not answer. Amen. S. B."

[From IV, in reference to Sally's taking a forbidden book:]

"I have every reason to believe that you are mistaken in trusting Sally. You cannot touch her by appealing to her honor. Do remember this. She is worse than a child, since she is able to masquerade as B I and so obtain credence for anything she may choose to say. In haste, but

"Very sincerely,"

Affairs finally reached a climax and IV's resolution was taken. She would kill Sally. Her other self was no longer to be treated as a rational person. It was nothing but a "delirium," and as such must be suppressed. I was entirely wrong, she was convinced, in my dealings with Sally, whose claims for recognition should receive no consideration whatsoever. IV was now to show us how to manage her case. She laid her plans with great care. First, she wrote letters to Dr. Hodgson and myself announc-

ing her plan and notifying us of her wish that we should not interfere. She herself under no circumstances would come to us for help. Here is the letter I received:

“I shall never recognize ‘Sally’ as anything but mental delirium, nor treat it with any more consideration in the future than I have in the past — with less, for I propose *killing* it, and I do not wish either you or Dr. Hodgson to interfere. You must let me quite alone, and send me away if, as ‘Sally,’ I appeal to you. As B I there will be no trouble. I am sure you will help me to help myself.

“Do not answer this, please. I begin treatment at once.”

The next thing was to head off Miss Beauchamp and prevent her upsetting the scheme by appealing for aid, as she was sure to do when the fight began. To this end she wrote B I a letter, using such arguments as she thought would appeal to her. She argued that I was entirely wrong in my views and treatment, that Sally was a delirium and could be cured by a different method. She then explained her plan, asked B I’s aid, and gave her directions for the part she was to play. After this she felt satisfied there was nothing to fear from B I. A letter was then despatched to Sally. Its temper was very different from that to B I. Appeals to Sally’s reason, she later explained to me, would have no effect. So she sent a message that was to make her arch enemy tremble. Freely translated, it meant that if Sally did not at once surrender and give up all her habits, ways, tricks, and annoyances, and pack herself off for good, bag and baggage, she, B IV, would consign her to everlasting oblivion.

For myself, I thought it would be interesting to let IV have her way and to watch the fight. Hostilities opened at once. Sally took the announcement contained in the letters as a declaration of war, and evidently believed in the military maxim of striking the enemy quickly before

he has time to arm. B IV had left the note, intended for me, in person at my door.

On her return, immediately upon entering her own room she found it draped in black. The only white object to be seen was a small plaster cast of a devil known as "Teddy." Teddy now grinned at her from his perch above the window, white and conspicuous against the black funereal background. Artistically suspended to Teddy's ear was a three-cornered paper pouch cunningly made. The pouch excited IV's curiosity; she must see what it contained. The moment she touched it a deluge of tiny pieces of paper fell to the ground. A note addressed to her from Sally now became visible. She opened it eagerly. Had Sally dared to defy her? If IV had had any doubts the note dispelled them, for it informed her that what she so boldly had insisted was only a "delirium" had already<sup>1</sup> seized and confiscated all the papers it could lay hands on, which meant all that she possessed, including many valuable pages of notes of lectures difficult, if not impossible, to replace. These were torn into little bits and now littered the floor. Next she found that the family purse had vanished.

The black drapery of the room, she was able to convince herself, was a hallucination, Sally's handiwork, and, with everything else, was to be ignored if Sally was to be crushed. So, resolutely disregarding everything that had happened, she began to change her clothes to go out again. What now happened I shall let her tell substantially in her own words:

"While I was brushing my hair a sensation of great fatigue came over me, the effect of the exciting day I had just passed through. I finished, however, and then as I sat in my chair,

<sup>1</sup> There was a brief interval after writing the letters and before leaving the house to deliver mine, during which Sally had come and seized the papers.

I stooped to change my slippers when, with a sudden shock of horror, I saw directly facing me at the opposite side of my room my own feet. They were white and shining against the black background. I fell back in my chair overcome.

“At once I was conscious of pain in my legs below the knees and of a feeling that my feet were gone. I felt for the moment certain that this was the fact, for I had no sensation below the seat of the pain. My legs seemed to end in stumps and I instinctively leaned forward to protect them with my hands, keeping my eyes fixed upon the feet opposite to me. But the next moment I realized that this too was but another device of Sally’s, intended to prevent my going out. I told myself this over and over again. ‘It is only Sally,’ I said. ‘It is only Sally’; yet I could not move or take my eyes from those feet. I had an agonizing desire to touch them and convince myself they were not real. But this seemed impossible. They were at the farther end of the room and I was alone. Then a great fear surged up within me. Sally had always treated my body as if it were not even remotely connected with herself, cutting, scratching, and bruising it in a way so shocking that it is hard to believe. Could she now have gone farther and really have done this? It did not seem impossible.

“I was in the greatest pain and could feel nothing below my knees. Finally, making a great effort, I threw myself on the floor and dragged my body across the room. I brought myself near enough to touch the feet; — they were bloody. I had only to stretch out my hand, but my courage failed, they were so ghastly. I waited; it seemed hours; I could only look at them. Then, making a supreme effort to touch, ever so lightly, the nearer one, I found my fingers stained with blood, and — fainted, or changed, I do not know which.”

The nights were made hideous for IV. To allow her to sleep was to give her a chance to renew her strength and courage. So Sally kept her awake the greater part of the night. Sometimes IV no sooner would get to bed than Sally, “coming,” would rise, throw the bedding on the floor, pile heaps of furniture on the bed, and turn the

room generally upside down. When satisfied that every thing was sufficiently uncomfortable she would change herself back to IV again. This would be repeated as often as IV got into bed. Every day she would spring some new impish invention upon her opponent. It would carry us too far to narrate them all here. Dressing was a burden, for every article of dress was hidden or damaged; meals repulsive, for she saw all sorts of unpleasant things in her food, and every movement painful, for she was bruised from head to foot. But IV was game. I saw her from time to time, but though exhausted from want of sleep she was still defiant and wanted no help. She was determined to conquer Sally. So I looked on without interfering, and watched the battle from afar. I knew that Sally would eventually down her.

The nightly visitations of Sally now took a different form. One night IV awoke to find herself perched upon a shaky structure composed of a couch, two chairs, and a dress-suit case. She was stark naked, and in an attitude as if posing for a statue. Her limbs fixed, as if by some occult power, unable to move hand or foot, she was entirely helpless save for the power of speech which would ill have served her under the circumstances. She could not call for help, for what a spectacle she presented! Another night, if it was very cold, an exposed position in the deep window-seat was selected as her niche; while the next night, if the pose was a reclining one, the hard surface of the top of the commode, measuring three feet by two, offered a sufficiently comfortable and commodious couch. In this position she was kept posing an hour at a time, "until," she wrote, "I would lose myself from anger, cold, and fatigue."

At first IV thought that Sally's intention in all this posing was simply to tire her out, but presently the real meaning flashed upon her. It was a punishment for her

sins She had been reading a certain book on art which had interested her deeply. There was no harm in that, — how could there be, for a clergyman had loaned it to her? But the book was highly objectionable both to B I and Sally. They had even appealed to me to forbid it. Now it was as plain as day that the attitudes she was made to assume were reproductions of the illustrations in the book. She recalled each one to her mind and, sure enough, her poses were those of the illustrations. She was doing the "living statue" act. "Sally doubtless thought," she said, "my conscience would enlighten me — and it has."

Again the attack changed. Hallucinations beset her on every hand. She saw herself surrounded with black, moving draperies. As she walked the streets, an endless procession of black-robed figures accompanied her, some with familiar faces, but most with countenances that changed horribly from moment to moment. Then, again, the hallucination involved her own body. She felt that her right hand had been lost, and consequently she was forced to use her left hand for everything. With this hand alone she was obliged to sew, to write, to lift, to bathe, to dress. The tiresomeness of it all oppressed her. Still there was no thought of giving in.

The climax was reached when Sally took to actual physical torture. One day IV showed me her arms. There were numerous and ugly scratches extending the whole length, evidently made with some sharp-pointed instrument. After scratching the flesh, Sally had bathed the scratches in alcohol and made them sting, saying it was good treatment; then she rubbed lemon juice in and said that was good treatment too. Poor IV was so sore she could not bear to have her arms or body touched. She was nervously worn and haggard from want of sleep, as well as from the mental strain to which she had been continuously subjected. The war had been going on now for



about two weeks, and she was so exhausted that Sally found it easy to play upon her mind as she would.

The worst of it was that B I suffered equally, though she was ignorant of the cause; the physical exhaustion of the one was shared by the other. It was surely time to interfere if I was not to have an invalid on my hands. I pointed out to IV the uselessness of it all, the wrongness of her own ideas, and the futility of her attempt to cure her "delirium," if such she chose to call it, by the methods she had adopted. She finally assented and yielded submission. There remained Sally to be dealt with. Presently the opportunity arrived. Sally was captured by surprise, though she tried to escape by pretending she was IV. I upbraided her for her behavior, telling her that all this ill-treatment of IV must stop, and that if she did not mend her conduct, I would close her eyes and ears for good, and put her to sleep forever with ether, and she never could come again. I talked long and earnestly on the condition of affairs. She was much impressed by the threat and her face fell, taking on an expression of depression and sadness. I told her she had better consider it well and make her choice, — either behave or go for good, and then left her alone in the room to think it over. On my return she had gone, but this note was awaiting me:

"I have thought it all over and decided that you may etherize me and close my eyes again. I will come and let you do it to-morrow — but please do not talk.

"C. L. B."

She was ready to commit suicide, to give up all the fun, the frolics, the sunshine of life, but her sorrow should be her own. It must not be talked about; that she could not bear.

But Sally was not ready the next day to depart this life. There was more for her to do before taking the final step.

People, before they died, wrote their "last will and testament," she explained, so she must write hers. It must have been a curious document. I never saw it, but I heard about it from IV, who was puzzled by what she read, not knowing what it all meant. Probably some freak of Sally's she thought; but Sally was in earnest. Then Sally wrote a number of letters stating her opinion about people. These and various other papers, the last pages of the "auto," letters from her friends which she treasured, little keepsakes and presents given her from time to time for her own, not to B I or IV, —all these she gathered together and put into a box. Then going far out into the country, in a secret place in a wood, she buried her box of treasures, that no eye might look upon them when she was gone.<sup>1</sup>

All this had to be done before Sally could "return to where she came from," and so it was that the next day she was not ready. I saw her by accident. Sad and serious, all her playfulness gone, she was like a person about to depart this life, who was saying good-by to her friends. At last she realized that the world was not what she thought it; her doll was full of sawdust. She could not do as she pleased and what fun was there for her? Everybody seemed to be against her. B IV was a horrid person. She did not like her; she did not like anybody but herself. As for me, I did not think or talk the same as she did. Things did not mean the same to each of us. People said she was a child and treated her like a child, and not as they did B I and B IV. She received nothing but scoldings. She used to like me, but I, too, said she was only an infant. She did not understand what other people meant and they did not understand her. Then Sally expressed some curious ideas about the relation of

<sup>1</sup> In later days this buried box of letters was a source of great anxiety to IV, who feared that some one might accidentally come across it—and what might it not reveal!

herself to her body. She insisted that her body did not belong to her, nor was it a part of her<sup>1</sup> any more than her clothes were. She simply used it but did not feel as if it belonged to her. Following up this idea, I plied her with questions, in answer to which she went into a long explanation, the substance of which was that she felt that she was just thought, without a body, and she seemed to have the idea that she could be independent of her body, if she wished to be, although she was not an "astral" body. She did not believe in "that kind of stuff."

There was a pathos in her child troubles that compelled one's sympathy in spite of everything. But much as Sally with her gayety and merriness would be missed, she could not be considered. "Carthage must be destroyed." Sally must die that Miss Beauchamp might live. At last dawn seemed to be breaking. Would Sally keep her resolution to go back to where she came from, or would she forget everything at the first temptation thrown in her path? A child's tears are quickly turned to laughter, and I knew it was unsafe to build too high hopes on Sally's new resolution; it could hardly be called reform. Still it was an opportunity not to be lost, if the family was to be restored to its original unity. Etherized Sally should be. Yet, if she disappeared for good, there would still remain two personalities. To combine them into one person required the consent of IV. Would she give it, now that she had seen the uselessness of struggling against fate, — I would rather say against psychical laws. Any hopes I had formed on this score were soon dispelled. Relieved from the attacks of Sally, IV was free to turn her guns upon her other enemy, or, if enemy is too strong a word, upon the one person, myself, who crossed her path and thwarted her desires.

The feud had left her exhausted, neurasthenic, psychi-

<sup>1</sup> It will be remembered that Sally had a peculiar form of anesthesia, which probably explains this idea.

cally disintegrated. It had always happened that when exhausted her ideas tended to become "insistent" or "fixed," and she herself became their victim. Governed by them she became rebellious, and when rebellious she would yield to no dictation, advice, or control. It cannot be disguised either that when disintegrated by exhaustion her temper, never at any time the best, became uncontrollable. The slightest provocation lashed it into fury. Sometimes, as a mere matter of experiment in the study of character and to demonstrate to others the differences between B I and IV, I would purposely arouse this temper. I had simply to assert an authority, when, in a flash, she would be boiling internally with rage, though externally she might endeavor to hide it. So, now that Sally had retreated, the objective of the war was simply transferred to me as the point of attack; hostilities did not cease. To repair the havoc which Sally had made, I sought once more to combine the personalities into one, to give to each the memories of the other. But again the old fixed ideas began to surge within IV and to control her. Ignorant of the seven years from 1893 to 1899, when B I alone<sup>1</sup> was in existence, she sought to break from us, her new friends, and to return to the old associations which Miss Beauchamp had severed forever.

Then again she saw herself, as in the earlier experiments, dominated by my influence. She felt herself when re-associated rejoicing in her mental attitude towards her new friends. The thought maddened her. "Not like B I, not like B I! *Never!*" she declared. She would leave us all, rather, and return to her old life.

The thought became an obsession. So it was that, with Sally's surrender, hostilities did not cease, but were simply transferred to another objective, to any of her latter-day friends who opposed her, and particularly to myself. Of

<sup>1</sup> Excepting, of course, that Sally was present during 1898-1899.

course all this, looked at from a psychological point of view, was nothing but the expression of the disintegration, the psychical havoc raised by Sally — a phenomenon of dissociation. From the standpoint of the physician, the only thing to do was to integrate again the dissociated psychical elements. The logical way to do this was to integrate B I and B IV into a single personality and make them whole. I succeeded again in doing this so far as to restore to B I, as the fundamental personality, the memories of B IV, as I had often previously done. The result was in one way fortunate and in another unfortunate. The unfortunate part was that it “squeezed” Sally, and she was unable, as she intended, to transform IV or I into herself and thus keep her engagement to be etherized herself. She remained helpless, out of sight, though IV was under observation. More fortunate was the other effect, that the modified B I, now conscious of IV’s attitude of mind, was able to lay bare the latter’s thoughts.

On April 16, 1901, after a contest with IV in which I came out best, I received a letter from the *New I*, who was anxious to apologize for her attitude as IV and to explain for my benefit the motives which were actuating the latter. I cannot print the letter in full because it refers to others and to private matters. It was an appeal for help against herself. After explaining and apologizing for IV’s attitude, she points out that IV’s desire to return to her old life “comes largely from ignorance; that, and a curious fancy that anything beyond the most formal expression of gratitude is disloyal to others.”

“ . . . I cannot bear to have my ignorance even hinted at. Forgive me! I tell you this only that you may understand better, not that you may refrain from probing me. I want you to do that, to help me, to keep me from going back. I have the strongest desire as IV to do so. . . . Sooner or later I shall give in to this, and then, — oh, Dr. Prince, what

then? I dare not think what fresh complications may arise. complications in which even you cannot help me, inasmuch as it is impossible to tell you of them. IV does not understand or realize the significance of these last letters. She is troubled by them only vaguely, as I would have been years ago. Do help her, or help me. Forget my weakness. If I could only see you, perhaps you might understand better.<sup>1</sup> If I do not, won't you show me this letter as IV and *force* me to be frank with you? You are the only one who can help now. . . . Stay with me."

Enclosed with this letter was the following from Sally:

"Please close my eyes again, Dr. Prince, with the ether. I thought you would do it to-day, but I could n't come. I'm not jealous now. This is all that [B] I wrote. IV wrote you too, but afterwards she tore the letter up. I have n't touched anything, and I just want my eyes closed. I'm all squeezed."

If I was to help Miss Beauchamp, IV must be controlled against her will by suggestion. To do this it was essential to change her into B II. But she could not be carried in hypnosis beyond B IV against her will. For this her will-power must be broken. She had resolutely prepared herself for the struggle by giving herself auto-suggestions against mine. Over and over again in the intervals of my seeing her she repeated to herself the old formulas, such as, "I shall not change," "Nothing can influence me," "I shall stay myself," "I shall tell nothing," "My will is the stronger," etc. As has been explained such suggestions affected B IV so that she could not be changed to B II. I thought of B I's pathetic appeal, and disagreeable as was the task, determined to do the job thoroughly.

The day following the receipt of the above letters I sent for her. As she entered the room a single glance was

<sup>1</sup> B I had written me numerous letters, but all had been destroyed by IV or Sally. This was from the New B I with IV's memories.

sufficient to detect hostility and rebellion in every feature and gesture. Her greeting was characteristic. She was there. What did I want? I replied, to help her and make her well. She wanted no help, she could take care of herself. If that was all she would go. Hereupon I tried the effect of (New) B I's letter and read it to her as requested. If the new B I thought this would have a mollifying influence she did not know her other self! Instead of becoming pacified, she grew furious. As words were futile, I proceeded at once to hypnotize her. A struggle ensued which was the most disagreeable I had yet encountered. I was tempted to let her go her own way, but thought of Miss Beauchamp's prayer for help. It was a battle of wills. She fought mentally and physically. She shrank from me and ran to the farther end of the room, endeavoring with averted face to avoid my eye. She tried to escape the grasp of my hand on her wrist, feeling, as she did, the intensification of the hypnotic influence by the physical touch. "You cannot hypnotize me. No one can. My will is the stronger. I shall stay myself." These and similar suggestions to herself she angrily exclaimed aloud. She tried not to hear, to make herself deaf to my voice.

I finally succeeded in changing her to B IV a, but in that hypnotic self there seemed to be injected all the concentrated essence of stubbornness, self-will, and resistance, of the superior self. It seemed impossible to hypnotize her "more deeply" into B II.

There was over her spine a "hypno-genetic point," pressure upon which always caused a thrill to run through her that weakened her will and induced hypnotic sleep. I pressed upon this point. As she felt the hypnotic influence coming over her, her will-power weakened. With a strength that I did not think she possessed she fought, wrestled, struggled to throw off my grasp, and to resist the subtle power. The rush of physical sensations through her body,

and the mental feeling that her consciousness was being engulfed in oblivion were more than she could bear. In mental anguish she shouted aloud. Thus for two hours we struggled. Each suggestion of hers I met with a counter-suggestion, but do what I would I could not get her beyond the stage of B IV a. At times, often, just as she seemed about to succumb, gathering her strength she would hurl, as it were, her will against mine, open her eyes, and wake herself up as IV.

I recognized that one or the other must be master. If I gave in, if she realized that her own suggestions were more powerful than mine, then it was good-by to all future influence. I called upon Sally for aid. "Sally will help," I said; "Sally will bring B I." But whether Sally would not, or could not help, B IV a for two hours remained unchanged.

Then, little by little, her will began to weaken, the hypnotic sleep, broken by momentary struggling only, began to creep over her; she became quiet, her resistance ceased. I called upon B II, and she was there.

What a change the picture before me presented!

"Oh, why do I behave so!" she exclaimed. "Save me, help me! Do not leave me, do not let me go," she pleaded. She was penitent, remorseful, as if *she* were the sinner, and asked only to be saved from herself.

A few suggestions were now sufficient to ensure a good night's sleep, to mitigate the fatigue, to dispel, if only for the time being, the "fixed" ideas, and to wake her up re-integrated, softened, calmed, with peace in her mind.<sup>1</sup> As she went out of the room one would not have recognized in the grateful penitent the stubborn fury who had entered more than two hours before.

<sup>1</sup> The neurasthenic condition brought about by the war was too profound for such changes to last long. She was certain to disintegrate again so long as her physical condition was unimproved.



The next day I received the following from Sally:

"I *can't* help you, really. I want to be etherized and have my eyes closed again. Please do it. I shall have to get the stuff myself if you don't.

"The auto is buried in a tin box, so that IV may as well stop hunting for it. You can tell her. There are some other papers in the box too, but they all belong to me."

It was destined that Sally should never voluntarily enter her living tomb. There were several factors at work to prevent this. In the first place, as already explained, the temporary "putting together" of IV and I "squeezed" her for the time being so tightly that she could not "come" at any appointed time for the purpose, and when at last she got her freedom again, daughter of Eve that she was, she could not resist a new temptation that was dangled before her eyes. Child-tears then had turned to child-laughter.

With IV's comparative restoration to health her fierce stubbornness was dissipated, though she did not lose her desire for freedom. The war was a failure, but she would, like the wily Greeks of old, gain by artifice what she had failed to do by force. The uselessness of attempting to "kill" Sally was at last realized. Perhaps she could bribe her! If by proper inducements Sally could be prevailed upon to make a friendly alliance, offensive and defensive, B I might be gotten rid of, the whole time and the family funds be divided between herself and Sally, and thus, on the principle that half a loaf is better than no bread, life might become tolerable.

Poor Miss Beauchamp was worn out by the everlasting fighting.

"Is there nothing," she wrote, "that I can do? No way by which I can attain peace. I am worn out by this constant warfare. If it would simplify matters, — you remember telling me once, how long ago it seems, that by blotting out the

memory of the years between 1893 and 1899 I might be cured — if this is still possible I beg you will do it. I felt then that I could not, even for my own salvation, give up the remembrance of so much that is dear to me. Now I realize that it is not a question of my salvation, or indeed of myself at all. I will give up everything, even coming to you, if you wish it so. I will do anything. Do I make this clear? I am afraid not, although it is so clear to me and has been ever since your letter reached me this morning. I had not realized before how much I was exacting from you in begging you not to leave me to myself. At first it was different, I think. You understood Sally and knew that I could not control her. It seems as if I *could* control myself as IV if I chose to make the exertion. I know it, and yet, Dr. Prince, all my efforts are worse than useless. They simply intensify that attitude of stubborn rebellion which seems my chief characteristic as IV. I have tried so hard to conquer this, and, failing, have set myself the task of gathering such data as I could from memories, in order that I might perhaps help you to understand it better and even perhaps to cure it. But it is too late, I am afraid. I am becoming more and more the slave of my other self. I feel the uselessness of struggling, the hopelessness of it all, and it is better that I should save you what I can. Forgive me! forgive me that I have kept you so long and have been so selfish!

“If you feel that by obliterating these years I can be cured, will you give me one more chance by stating it to me either as I or IV? If I refuse to take advantage of it or in any way make difficulties for you, send me away. I have deserved it, heaven knows.

“If I am mistaken, and there is no longer this hope of cure, you must still send me away and so save yourself. I wish it so. Believe me.

“I cannot write any more, but I trust you will be able to understand this. My head aches too badly from sleeplessness for me to be quite sure that I have expressed it as I should, but you will understand as you always have.

“Again forgive me.

“P. S. I leave the paper with this, hoping it may not be too late to use it.”

The following shows us the way B I's grieving affected IV:

[From IV.] "I am going away to-morrow to stay with some friends. It is very lonely here, and B I's constant grieving wears on my nerves. It is harder to endure than one would believe possible. I would rather give and take with Sally — a thousand times rather.

" Hoping you have forgiven me for accusing you falsely,<sup>1</sup> I am,

" Most sincerely yours,"

B I was in distress. Something was going on, something was being carefully concealed. B I was held a prisoner, unable to communicate with me in person or by letter, excepting occasionally, and then, as it afterwards transpired, only after the letter had been viséed and approved. Some days went by during which I heard nothing more from Sally about her self-proposed suicide. Had she changed her mind, and, if so, what was the inducement?

In the course of a few days, an apparently trivial incident gave the first clue, and then there fell accidentally into my hands part of a secret correspondence which was plainly so incriminating that there was no use in further concealment. The plot was revealed and a full confession followed. The first disclosure came when hypnotizing IV. Being unable to obtain II but only B IV a, I told the latter to awake as B I. She woke instead as B IV, saying in response to questions, " You told me to wake as IV." She had heard a voice saying, " Wake as IV." It was not mine, it could be only that of Sally, who had perverted my words and given her a hallucination.<sup>2</sup> Sally, then, was in collusion with IV and had prevented my getting II. What

<sup>1</sup> Probably referring to letter about promises (page 479).

<sup>2</sup> It is worth noting that this auditory hallucination was heard by IV, probably because the internal voice continued for a moment after the change had been made to IV.

motive could Sally have for abandoning her intended suicide and forming an alliance with her former enemy against my efforts to help?

The next day, after a long and serious talk with Sally, I left her alone in the room. Returning unexpectedly, after an absence of a few minutes, I surprised B IV reading some scraps of paper which she hastily tore up on seeing me. I confiscated them at once and, pasting the pieces together, read the following communications from Sally to IV:

“To IV. Nobody has been here but me. [B] I wants to stay *dead* all the time, so you can make any arrangements you choose with people. I told Dr. Prince you were very horrid, and that you broke all your promises to me, and that you fussed continually because I kept mine — I *did keep* them, you know, every one. But I have n’t told him a single thing else.”

“To IV. [B] I is n’t going to write him or appeal to him or interfere in any way whatever with what you do. She wants to go abroad now and she hopes you ’ll stay there and never, *never* come to Boston again. She resigns things entirely to you.”

“To IV. Don’t show these notes to Dr. Prince. He will sit on you because he wants B I. Amen.”

Sally and IV were plainly in collusion. The first of these communications should be read in connection with the following letter received that same morning:

[From Sally, May 7th.] “B IV said it would be only a little while, Dr. Prince, and it ’s been a long, long while now, and she has n’t kept a single promise yet, and she fusses all the time because I keep my promises so strictly. I ’m tired of her, and I ’m coming up to see you instead. You are n’t cross still, are you? You said in the note you would n’t be. [B] I ’s going to be dead all the time ‘to save complications and because she wants to save you trouble.’ Isn’t she a goose? She has n’t made any last will and testament like mine. Mine ’s buried in the woods now, where it won’t be found for years and years.

She ought to make one too, ought n't she? Some of the spirits who neglected to do so are awfully troubled now, and they try in every sort of way to atone for their carelessness. Do you think B I will be a spirit? This is written so queerly for I wanted to use the paper IV used,<sup>1</sup> but I've numbered everything so you can follow. I think IV's very nervous, she's been walking a lot and in that awfully excited sort of way. [B] I's nervous too, and thinks she has beads, as they have in the book, — to pray with, you know. She's praying to be dead, and for me, and IV, and that you will keep her, and all that.

“I think I won't write any more now. I'm coming to your house to-morrow morning if they are n't ill, and I want you to please give me my autobiography again. I've been good so long.

“S. B.”

From this letter, which said nothing about suicide, it was clear that the feud as well as tears was over, and that Sally and IV had made promises to each other and probably had struck a bargain. IV had said “it would be only a little while” to wait, but impatient Sally had already begun to be “tired” of her bargain, while, as one of the messages to IV showed, in her interpretation of the agreement she had stuck so literally to her promises that IV was much handicapped in carrying her plans through. The letter to me was evidently meant to be a peace-offering in the shape of secret information, but Sally spoke the truth when she wrote, “I haven't told him a single thing,” — that is, about the plot.

The disclosures of the confiscated messages culminated in a full confession from IV. She had bribed Sally. Instead of a living tomb she offered her half her kingdom, and the earthly temptation had been too much for Sally to resist.

<sup>1</sup> This was written on the blank portions of four sheets of paper which B IV had used in attempting to write me. As often as she began, something changed her to Sally and interrupted her letter. Finally Sally wrote her own letter on the unused portions of IV's paper.

B IV had been invited to visit Europe. She determined to go. She also determined never to come back. In Europe, untrammelled by me and those who controlled her here, she would obtain freedom at last. But in order to live her own life, to manage her own affairs alone among strangers, the co-operation of Sally was necessary. Not to know one moment what she had done or said the moment before, or where she had been, might be well enough at home but would be intolerable in a foreign land. Sally could help her, could keep her informed of what had gone before, could aid instead of opposing, and together they could quash B I. If B I could be obliterated and Sally's co-operation obtained, the scheme was feasible. IV made overtures.

One of Sally's grievances against IV was that the latter refused to recognize her as a "real person," and regarded her only as a "delirium." Then, IV's air of superiority was more than Sally could bear and stung her to the quick. With great astuteness, IV now proposed to Sally to recognize her as a real person and to make various other concessions provided Sally in return would do certain things.

On IV's part, besides the recognition of Sally as an equal, with all the rights and privileges pertaining to a sane member of the family, she would concede to Sally :

1. Half the family funds to spend as she pleased.
2. Half the time.
3. The right to employ her time in her own way and after her own tastes, particularly after arriving in Europe.

In return for this Sally, on her part, was to :

1. Keep IV fully informed of everything that took place while Sally and [B] I were on the scene.
2. Help IV in awkward situations, when she was pressed about matters of which she was ignorant.<sup>1</sup>

<sup>1</sup> IV suddenly coming to herself would be ignorant of what had occurred a moment before when she was Sally. If pressed by questions, there would

3. Prevent B II from giving me any information which IV did not wish me to have, particularly about this European scheme.

4. Combine with IV to get rid of Miss Beauchamp by suppressing her letters, preventing personal interviews between her and me, and generally terrorizing her by misinformation, threatening letters, and a dozen other ways.

5. Conceal all from me.

All this fell in with Sally's wishes. To have money of her own, to do just as she pleased, to have the time of her life in Europe, as she pictured it to herself, was a temptation not to be resisted. So all thought of ether and suicide was abandoned. The bargain was struck and a coalition

be no time for Sally to warn her. Under this agreement Sally devised a scheme to get over these awkward situations. On one occasion I witnessed an interesting exhibition of this phenomenon, illustrative of Sally's method of helping IV out in accordance with this bargain. In reply to an objection which I made to IV in regard to going to Europe, on the ground that her ignorance of herself in her other characters unfitted her for travel, she claimed to know everything that she did as B I. I at once challenged her to tell me what she as B I had written in her last letter. Upon this she at once fixed her eyes on vacancy, went into a condition of abstraction or half-way dreamy state, and *repeated almost word for word the language of the letter*. In this state she remained conscious of her surroundings. When she had finished she went on talking, continuing the conversation as if nothing out of the ordinary had happened. I challenged her to repeat the act. She proceeded to do the same thing over again. But after she had repeated a few sentences I gently slapped her face and aroused her, thus preventing her from relapsing into the dreamy state. She was then unable to repeat the letter. By going into the dreamy state she was able to converse for the time being with the complete knowledge which Sally possessed. When she came again to herself *she had no knowledge of what she had said*. It was to be inferred that while in the dreamy state Sally spoke through her tongue. The phenomenon was automatic speaking, and, in principle, identical with the automatic writing which Sally so often performed. It was therefore a phenomenon of dissociation and differed from the "mind-fixing" memory which was a phenomenon of synthesis of the dissociated experiences of B I.

Another scheme for helping IV out of difficulties was a code of signals arranged between her and Sally. When IV was asked some question about matters of which she was ignorant, Sally would give her the cue by "automatically" stroking the palm of one hand with the forefinger of the other. A stroke to the right meant Yes, and a stroke to the left meant No. IV would thus know whether to answer in the affirmative or the negative.

formed against B I and myself. Poor Miss Beauchamp was in despair. She knew but a small part of it all, but what she knew was enough to terrify anybody. The trip to Europe, which was not a secret, she felt she could ill afford. The financial consideration alone was an anxious one.

The following letter from B I gives an insight into the condition of her mind at this time:

"I do not mean to be unreasonable or to make things hard for you, but it seems as if it were absolutely necessary for me to have some clear understanding about the summer. If I could only keep myself without changing for one half-hour, I would put you in possession of all the facts and fancies that are distracting me. My extreme need of you renders this very difficult. As soon as I have an opportunity of speaking, so much crowds into my mind at once that I am, literally, lost. With writing, it is practically the same. I do not know what to say. I need your questioning to enable me to discriminate between the important and the trivial. This European trip is becoming a perfect nightmare. You know, as IV, I have promised to leave two weeks from Saturday, and Miss K. has made all her arrangements accordingly. I shall go, of course, but how, I leave you to imagine. I have also promised to *stay* abroad, not returning when Miss K. does. This, too, I shall probably be mad enough to hold to, although just the thought of it is enough to terrify me now. There are other things weighing upon me, — they give me no peace and will not until I have seen you. If it is impossible, if I am not to see you again, won't you for very pity's sake force my confidence as IV? I know that I am asking a great deal of you, but I have no one else and you will not fail me after all these years. Even as IV, I am still [B] I.<sup>1</sup> Do you realize that? I wish I could reply to your defence of the paper, but it will have to wait until I am in possession of all my faculties. You must have received it by this time, and will see from my corrections what I meant by the

<sup>1</sup> That is, herself. Miss B. always considered that, after all was said, all the personalities were herself.



mixed figures . . ." (unfinished. Without apparent connection the letter continues:) "It is hard for me to do so and harder yet to acknowledge it — but it is true."

Further, IV was in communication with Anna. That she also discovered from letters. What might this not portend!

IV's administration of the family finances was most injudicious, and, from Miss Beauchamp's point of view, extravagant. How was she to manage if this went on? Now, to add to all this, Sally began once more to pour upon her a broadside of letters, telling her in substance that she was of no account to anybody, that I was tired to death of her, and so was everybody else, that she was not wanted, and that we should all be much obliged if she would keep herself out of the way. All this inside information Sally of course was supposed to pick up for Miss Beauchamp's benefit during the time when she, B I, was "asleep," for Sally might well hear much that B I did not hear, and what else could Miss Beauchamp do but believe?

Miss Beauchamp gave up in despair. No wonder that she had hallucinations and told her beads. She resigned herself to her fate, and acquiesced in the demand that everything should be left to IV and Sally. As Sally said, "B I wishes to be dead." Sally kept her part of the bargain. It was now clear why I could not get B II, or, if I did, why whenever I asked a question embarrassing to the Two she immediately changed to B IV a.

IV after all had conquered her delirium, for if she had not killed it she had bribed it.<sup>1</sup>

<sup>1</sup> Of course I disclosed the whole plot to Miss Beauchamp and proceeded to set things right once more. In due time it was arranged that Miss Beauchamp should sail for Europe under proper auspices. The trip did not turn out as happily as had been anticipated, although she went under circumstances that promised well. It was a demonstration of the necessity of constant supervision. Miss K., a friend of long standing, to whom her infirmity had been explained, had invited her to go. I happened to be in Europe that summer, and though I did not see her, was the constant recipient of letters from both IV and I, that revealed a most unhappy condition of affairs. The mental distress of each, as well as the strain of maintaining self-control, was

so severe that even Sally tried to help. I never knew exactly what had happened until my return to America, when an investigation disclosed the fact that in Paris B IV had had a vision, which, in her rattled condition, she mistook for reality, and consequently labored under the delusion that she had been the victim of an episode which made the continuance of the pleasure trip a mental torture. This vision, which I do not feel at liberty to disclose, had appeared to B IV, but was the revivification of an emotional experience which had really occurred long ago to Miss Beauchamp as B I before B IV came upon the scene, and which the latter therefore knew nothing about. (B IV and B I when in a badly disintegrated condition frequently had visions which they could not distinguish from reality. Indeed many of Sally's productions they believed real.) This Paris vision was the chief cause of the family troubles during the remainder of the journey in Europe.

## CHAPTER XXXI

### A HALLUCINATION FROM THE SUBCONSCIOUS

ONE day, January 8, 1902, I had an opportunity to witness some important phenomena bearing on the genesis of visions and internal voices. The biographies of saints, like Catherine of Siena, and Francis, the founder of the Franciscan Order, and of leaders of religious thought like George Fox the Quaker, John Bunyan, and Savonarola, to say nothing of minor lights like Savonarola's follower Fra Silvestro, are replete with accounts of visions and internal voices which once upon a time were interpreted as visitations or supernatural messages of one kind or another. The researches of recent years in abnormal psychology enable us to understand the genesis of these sensory automatisms, even if we cannot yet explain their exact psychological mechanism. In the light of this knowledge it becomes clear that they are due to the auto-genetic influence of the subject's own thoughts, conscious or subconscious.

The fact that B I and B IV were disintegrated selves, with an abnormal subconsciousness (Sally), rendered them particularly suitable subjects for spontaneous hallucinations of this kind. It only needed the psychological excitation to induce the phenomena. As a fact they have often been the victims of such visual hallucinations. The interest in the present instance lies in the fact that the subject was under observation while the phenomena manifested themselves, and the subconscious antecedents could be verified.

On the occasion when the phenomena which I shall now describe occurred, there awoke out of hypnosis a state which clearly differed from both B I and B IV. I had seen this state momentarily on several occasions. With the exception of a hallucination under which she labored, she was so natural and appeared so normal, that I questioned for a moment whether this might not be the Real Miss Beauchamp. In manner she was frank, simple, and communicative, but she talked of matters with which I was not familiar and asked personal questions which seemed to be entirely irrelevant to myself. I was puzzled at first, for there seemed to be no connection between the matter of her remarks and my own life. She referred to events not connected with myself and to a profession not my own. It soon became clear that she did not know me, in fact had never heard of me. She thought the year was 1893 (that is, about the time of the hospital episode), to which period she had gone back. Everything that had occurred since that date was a blank to her and therefore of course I would be a stranger to her mental associations. Under the dominating influence of her belief it was plain that I was taken for some one else, who ever that some one might be. Her manner was very much the same as that of B IV on the night when she first appeared, June 7, 1899. She talked of old times, of the past that B I had buried and had promised that she would speak of to no one. She spoke of persons and places and events of which I knew nothing, and asked questions impossible for me to answer. It was as if she were still living in the past, at a time preceding the events of the last nine years.

The true significance of this conversation, in relation to the phenomena which were to follow, was only understood when interpreted later by the Real Miss Beauchamp. So far as I could see there was no reason why she should not speak about these things and this part of her life openly,

but Miss Beauchamp explained that what she had revealed she had years before solemnly promised should never pass her lips. It was a girlish promise, and for that reason perhaps had made a profound impression on her emotional mind, and had acted like a dominating suggestion given in hypnosis. Sally, too, as it turned out, was keenly sensitive about the promise. I was innocent enough, not seeing any reason why she should not talk of her past. The point of importance, from its bearing on what was to follow, is that she had broken her promise. She was not, however, conscious of the fact, for she thought she was talking to the person to whom she had made it.<sup>1</sup> I made every effort to dispel her delusions, particularly that regarding my identity, and tried to make her realize the circumstances of her present surroundings. It was in vain that I denied what seemed palpable, sane facts to her. She was only pained that I, in insisting that I was not the unknown, hallucinatory person of her dream, could be so flippant. "Very well," I said, while arguing against her hallucination, "if I am not Dr. Prince, who am I, then?" When attempting to reply she was struck with either aboulia or dumbness, and could not speak. Thereupon, I said, "If you cannot speak, write my name on this piece of paper." She took up the pencil, but at once stopped and listened. A warning voice which seemed to her to come from the next room sounded in her ear, "Don't, don't." Each time that she would try to write or to speak the words she would hear again the voice saying, "Don't, don't," and, for a long time, her attention distracted, she would be unable to proceed and would remain motionless, listening to the voice. Finally, her hand, instead of writing an answer to my question, wrote, "Don't, don't." The

<sup>1</sup> It would seem almost unnecessary to point out that she broke the promise, not because of being in hypnosis, but because of being misled by the illusion.

moment the words were written she herself regarded them as nonsense, not seeing any significance in the word "don't." She did not realize, as B I and IV would have done, that these were automatic messages of warning from Sally; for, having gone back eight or nine years in her life to a period antedating Sally's appearance, she did not know that there was a Sally, and had no remembrance of her previous experiences with automatic writing by that personality.

At the moment, in my ignorance, I did not treat the matter very seriously, but, taking advantage of her ignorance of the different personalities, I wrote this message to Sally: "Is n't this a joke, Sally?" But when she tried to read this simple question the words had no meaning for her. I do not mean simply that she did not understand the question, but the words themselves appeared to her as those of an unknown language; they were mere jargon, as they would be to a person with word-deafness. Yet when handed a copy of the Congressional Record she read it with ease. She was so troubled by this alexia that, to ease her mind, I called the writing Hebrew.

After a while I succeeded in rehypnotizing her to B II, whom I awakened as IV. B IV was entirely ignorant of the past hour, and was under the impression that she had only that minute been awakened from hypnosis. She was standing before me, quietly conversing, when, of a sudden, she stopped short in the midst of a sentence and listened. She appeared to hear something that was unheard by me. As she listened, a look of fear and anguish came over her face. "I must go, I must go," she said. "What is it? What do you hear?" I asked, at the same time detaining her, but she paid no attention to my question. She heard a voice that she knew was *his* voice. It seemed to her to come from behind; she turned, and saw her former preceptor. His face was sad, as of one who had been injured.

“How could you? How could you have betrayed me?” she heard him say; and, as she heard these words and looked upon his face which reproached her in its sadness, her own features were convulsed with grief and pain. “I must go, I must go,” she pleaded, and sought to escape from the room.<sup>1</sup>

After witnessing a scene like this, dramatic from the intensity and reality of human feeling, as well as from the character of the phenomena, it is easy to understand the genesis of the visions which have influenced many historical characters and which have often made history.

The mechanism by which the hallucination was brought about is intelligible up to a certain point. In the first place, the predisposing conditions of disintegration and the doubling of consciousness were already present, B IV being a disintegrated self and Sally a subconsciousness. Now, when IV awoke, the memory of the past hour remained in Sally’s consciousness. For reasons it is not necessary to go into, it was a matter of intense feeling with Sally. She, too, was under the influence of the promise and had guarded it with zealous care. Subconsciously, her thoughts were keenly regretful. We had here, then, all the mechanism necessary to excite the hallucination which arose before the primary consciousness. This hallucination almost literally expressed the thoughts which possessed and stirred the subconscious self. Our conception of a conscience has of course only a moral and not a psychological significance. But if it is true, as there can be little doubt, that those thoughts which are ascribed to one’s conscience have often a subconscious abode, then we may well say that B IV’s hallucination was the expression of the *prickings of her conscience*.

The evidence showing that subconscious ideas can give

<sup>1</sup> On another occasion B I had a religious hallucination which likewise expressed the qualms of her conscience.

rise to hallucinations in the primary consciousness can be obtained experimentally. For instance, in the subject M—1, to which frequent reference has been made, we were able by a well-known method experimentally to induce hallucinations, through subconscious ideas. It will be remembered that after an attack his hand was completely anesthetic, but it was proved by producing hallucinations that the tactile sensations were subconsciously felt. Told to look into a glass of water and describe what he saw, he had a vision of a hand, and on the back of the hand he saw a number which corresponded with the number of times his hand had been pricked. If pricked five times he saw the number five, and so on. In other words, under the influence of the suggestion that he would see something, the five subconscious tactile sensations transformed themselves into or excited—express it as you will—a visual hallucination.

Such experiments can be varied in many ways. During the course of this study it will be remembered that Sally subconsciously induced in B IV and B I time and again hallucinations which were visual representations of her own subconscious thoughts. Sally thought of a snake, and “willed,” and straightway B I or B IV saw a snake. B IV had, indeed, another hallucination, similar to the one I have just described as the prickings of her conscience. The vision was of myself, and upbraided her in language I had previously used for disobeying my expressed wishes. (See Appendix O.) The words and vision were the expression of Sally’s thoughts. The evidence is conclusive that subconscious ideas can excite hallucinations in the primary consciousness. It follows that we may not be able to determine the genesis or origin of any given hallucination without knowing the content of the subconsciousness. If some one versed in abnormal psychology had hypnotized the numerous saints and sinners who have experienced visions



and voices and examined their individual consciousnesses, we should know much more about the origin of their hallucinations.

But it is not at all proved that the ideas that give rise to hallucinations of the kind we are describing are always subconscious. It seems to be equally certain that an intense dominant belief or other idea in the personal consciousness may as well give rise, under favorable conditions, to these phenomena. Given a certain degree of instability, it would seem, so far as we know, of little consequence whether the genetic idea is conscious or subconscious. A strong, dominant idea, like a belief, under these conditions could readily give rise to hallucinations which would be the visual or auditory representations of that belief; just as we have seen that a systematized anesthesia may be produced by a dominant belief. It will be remembered, for instance, how B I, dominated by the belief that her rings were lost, was unable to see them on the string tied about her neck, and yet, subconsciously, the rings were perceived. Indeed, one subconsciousness (Sally) tried to make B I see the rings. The anesthesia was therefore produced by the personal, and not by the subconsciousness. We have also seen the phenomenon of an illusion brought about by the same kind of idea, — B IV, on the night when she first made her appearance, mistaking her surroundings under the belief that she was in the Providence Hospital. Here again subconsciously she recognized the true situation, just as Sally, in the scene preceding the hallucination which is the subject of this chapter, recognized her surroundings, the person to whom she was talking, and the delusion under which the primary consciousness was laboring. These delusions are best explained as the expression of a dominant belief of the personal self. Similarly B I and B IV frequently had, when in a badly disintegrated state, hallucinations which were the visual representations of their ideas. It is diffi-

cult, however, in all such cases to exclude the co-operative influence of certain other dissociated (subconscious) ideas. It is only through a psychological analysis in hypnosis that we can determine what is in the subconsciousness and what elements take part in the mechanism of hallucinations. Nevertheless, the chief factor in a large class of cases must be the dominating ideas, whether hopes, aspirations, or beliefs, of the primary consciousness.

Applying what we learn from abnormal psychology to the visions and voices of historical personages, as we are entitled to do, we may safely conclude that these hallucinations were sensory automatisms generated by their own thoughts, conscious or subconscious. When we look deeper into the mechanism of these hallucinations and seek for an explanation of the mode in which ideas transform themselves into visions or voices, we find that as yet we have very little definite knowledge.

For a proper consideration of this problem we must have all the data before us. For the present, I will content myself with pointing out that disintegration of mental associations facilitates the genesis of hallucinations, and that a certain amount of dissociation is probably always necessary. The greater the instability and suggestibility of the mind, the greater the ease with which visions and voices are induced. Thus Sally found it easy to produce hallucinations in the different personalities in proportion to the degree of mental ill-health existing, and the degree to which they were, so to speak, "rattled." The better the health and the more complete the fusion, the less control Sally had. When the personalities were completely fused into one, Sally could not influence this stable personality, and we shall see that, when the Real Miss Beauchamp was finally obtained, Sally "went back to where she came from," without power to produce sensory or motor automatisms or other dissociation phenomena.

The same thing is true of the conditions which are favorable for the induction of crystal visions in ostensibly healthy people, and of hallucinations in hypnosis by suggestion. For crystal visions a certain degree of abstraction, which is equivalent to a doubling of consciousness, is necessary, and hypnotic hallucinations necessarily, as the condition of the experiment, mean dissociation.

## CHAPTER XXXII

### THE REAL MISS BEAUCHAMP AT LAST, AND HOW SHE WAS FOUND

THE fall of 1901 was occupied mainly in experiments in the amalgamation of the disintegrated personalities and the resurrection of the real self. These, it will be remembered, had been interrupted by IV's opposition, and with the exception of desultory efforts, had been suspended until a favorable opportunity should arise. After her late bitter experiences B IV seemed to have been impressed with her inability to manage her own affairs, and to have acquired sufficient humility to make it worth my while to resume in a systematic manner the attempt to resurrect the lost self. The same method as before was employed. As a result, during the greater part of the time, a personality was obtained and kept in existence which seemed to be a combination of I and IV. She had the memories of both, but, as in the earlier experiments, she was almost always in character either more IV than I, or *vice versa*. In other words, notwithstanding the synthesis of memories she was either I or IV, although distinctly modified.

On several occasions, however, a personality was obtained who exhibited all the evidences of a perfect fusion of the two personalities. She remembered her life as I and as IV. She had lost the bad temper and wilful self-determination of IV, and the emotional idealism of I. She was just a normal, healthy-minded person, and when she was in existence Sally sank out of sight, "squeezed" and imprisoned,

helpless within the Bastille of the healthy mind and unable to get out.

Although such a person was obtained, her appearance was infrequent, capricious, and uncertain. Suggestions to B II<sup>1</sup> usually resulted in the less perfect amalgamation, in the "New IV," as she was termed in my notes, and there seemed to be no way of determining with any exactitude what kind of (that is, how complete) a personality would be obtained. Suggestion modified the disintegrated personalities, made them more complete, and synthesized larger groups of psychical elements, but it could not be foreseen exactly what kind of person would be produced; and, as has been said, a complete fusion was obtained only in rare instances.

The method of procedure was therefore faulty. Although it had produced results which scientifically were of value in demonstrating that the real self was a fusion of I and IV (as will be more explicitly pointed out), yet practically it was faulty on account of its unreliability. It was plainly necessary to find a method which should give constant results. This was shortly to follow, as the outcome of the circumstances which led to the hallucination described in the preceding chapter, and to solve the important questions, "Who and where is the Real Miss Beauchamp?" and, "Who is B II?" It will be remembered that it was B IV who had that hallucination. She was standing before me, distressed in mind by the vision she saw, and the words she heard. It was plainly impracticable that she should be allowed to go away under the influence of this phenomenon, perhaps to have it repeated at home while

<sup>1</sup> B IV could not wholly resign herself to her fate, and continued to make auto-suggestions which more or less antagonized my own and modified the resulting personality. But aside from this, the fault in the method is now clear, and though its recognition throws light on the problem of multiple personality, a consideration of the matter would involve too wide a digression at this time.

she was alone by herself. So, with the aid of a little ether and suggestion, she was again put into hypnosis, and changed to II, *who was told to awaken with all her memories.*

The person who appeared before me this time was neither B I nor B IV, but seemed a harmonious combination of the two. She had all the appearance, at least, of being the person for whom we had so long been hunting. Immediately after this experiment the following letter, written on her return home, was received from Sally:

[From Sally, Jan. 8, 1902.] "How could you! She is put together, and now I know all her thoughts<sup>1</sup> as I used to. Are you glad, really? . . . She has written you too — another letter — but I wish to keep it until to-morrow. *Please* be nice to me.

"C. L. B.

"Wednesday — I did not want you to talk."

It remained to put the alleged Real Miss Beauchamp to the test.

Responding to a summons (Jan. 10) the new personality was put through an exhaustive examination to test her character and memory:

"Miss Beauchamp," my notes read, "seems completely put together. She is neither B I nor B IV. She herself is unable to say which she is, but remarks simply that she does n't know. In manner and attitude of mind she is natural, simple, amiable, ready to give all the information desired, and to aid in every way in her power, excepting, for obvious reasons, she does not wish to give up B IV's autobiography. [B IV had been writing an autobiography to contradict some of Sally's statements.] She recognizes, she explains, the absurdity of the point of view from which as IV she wrote it, and seems to be somewhat ashamed of it, for now everything appears in a different light.

"Testing her memory for the past and present I find that, with the exception of the periods when Sally has been in existence,

<sup>1</sup> Referring to the fact that when the fusion was not complete (Chapter XXIV) and the resulting personality a modified IV (the "*New IV*") as had of late been generally the case, Sally did not know her thoughts.

she has a complete recollection of her whole past life, not only of the years preceding 1893, previous to the hospital catastrophe, but of the interval between 1893 and 1899, when B I alone was in existence. She recalls the successive events of those six years as B I, including her life in college and the first year under my care. [Of this period B IV had no personal recollection.] In addition to this she described various interviews between B IV and myself and numerous events of B IV's life of which I had knowledge. She distinguished clearly the various periods when she was B I and B IV, and recognized her different characteristics in each. It seems to her now, for instance, that when she was B I she was simply distressed and tired, while when she was IV she was comparatively well and buoyant. It was a difference in moods and health."<sup>1</sup>

She explained her attitude of mind as B IV at the time of her first appearance in 1899 as follows :

“ Although then she was conscious of the gaps in her memory corresponding to the periods when the others were present, they did not, as a rule, strike her as anything very extraordinary. Her refusal as IV to admit those gaps and her general attitude of rebellion were due to the fact that she found an apparent stranger arranging her life and ordering her about, something to which she had not been accustomed and which she naturally resented.

“ During the first summer she was in a buoyant state of mind, without any sense of responsibility and indifferent to consequences. Physically, at that time, she (IV) felt quite well and enjoyed life.”

Besides the matter of memory and moods for the determination of the real self, there were the questions of health, stability, and suggestibility. Suffice it to say that this new self (when tested by after experiences) answered the requirements. Physically she was well. The neurasthenia had vanished in the twinkling of an eye. In place of pains,

<sup>1</sup> Later the Real Miss Beauchamp aided in an elaborate analysis of her different characteristics in these states. (Chapter XVII.)

fatigue, and insomnia, she boasted of a joyous feeling of well-being, of freedom from every discomfort, of peaceful nights, and sleep free from disturbing dreams. She neither saw nor heard hallucinations; she was free from impulses, obsessions, and aboulia; she exhibited no abnormal suggestibility.

Without going further into a description of this personality it was apparent that Sally was right. Miss Beauchamp was all "put together" and we had the real self. There she was, but how was she to be kept, or to be got again? She certainly was most fickle in putting in an appearance. The theory that B II was the original self, asleep, and that it was only necessary to wake her up to bring her back to life had been tried and failed. When awakened she had become a disintegrated personality, little better than a dement.

We had found the original Miss Beauchamp, but, owing to the failure of all methods to bring her at will and keep her, she seemed as far away as ever. The problem of how to bring her was soon to be solved.

The new Miss Beauchamp readily consented to be hypnotized, becoming first B IV a, and then B II. Sally was now summoned. There was no bouncing in of that young lady as there had been. It was only after some fifteen minutes had passed and considerable obvious struggling that she appeared. She excused the delay by averring that she now found much difficulty in "coming"; she was "all squeezed"; and what a transformation from her former self! There was no sauciness and do-as-I-please air now, but meek and lowly, her feathers drooping, she was ready to eat humble pie and do my bidding. Much of her meekness was due to the revelations of the disintegrated personality described in the preceding chapter, and the rest to the feeling that her power was waning and her days numbered. She acceded to every demand, and promised



no longer to tease, annoy, write to, or interfere with Miss Beauchamp. "But if 'It' is all well," she protested, "I can't get out or be able to 'come.' I shall go back to where I came from. I can never get out when she is well."

And now came confession, dragged from her perhaps under coercion, but still a confession. This she said was the Real Miss Beauchamp who had been present. Sally knew her thoughts. Further, *B II was the Real Miss Beauchamp with her eyes closed*, or, so to speak, asleep.<sup>1</sup> If she opened her eyes she would be the Real Miss Beauchamp.

I reminded Sally that that had been my theory some time before, but that it had to be discarded after the experiments when I told II to open her eyes and awake.<sup>2</sup> Instead of becoming normal she went into a condition of mental disintegration. She became "rattled" and the victim of hallucinations. At this Sally laughed and a mischievous look came over her face. Finally, after some hesitation, she confessed, "I did that. I did it to make you think it was n't she, and to prevent your getting her." I doubted her story. "Well, just try it," she replied, laughing. "I won't interfere."

Taking Sally at her word, I put her statement to the test at the next interview. I changed Miss Beauchamp to B II. "You shall open your eyes, awake, and stay yourself, your real self," I commanded. B II opened her eyes and before me I saw again the Real Miss Beauchamp. She was a person so different from B I and B IV, so natural and self-contained, and so free from every sign of abnormality that there could be no doubt that I had again the Real Miss Beauchamp. There was none of the suffering, depression, and submissive idealism of B I; none of the ill-temper, stubbornness, and reticent antagonism of B IV. Nor was there any "rattling" of the mind, hallucination,

<sup>1</sup> That is, hypnotized.

<sup>2</sup> Chapter XVIII.

amnesia, bewilderment, or ignorance of events, as had been the case in the earlier experiments. She knew me and her surroundings and everything belonging to the lives of B I and B IV. She had the memories of both. Synthesis persisted.

“Who are you?” I asked.

“I am myself.”

“Where is B I?”

“I am B I.”

“Where is B IV?”

“I am B IV. We are all the same person, only *now I am myself.*”

After this the Real Miss Beauchamp could always be obtained by simply commanding B II to awake — provided the family was at peace. The transformation was as gratifying as it was striking. To bring, at a word of command, a natural person with whom one could talk frankly and freely, without arousing angry opposition on the one hand, and without inducing depression on the other, who was ready to co-operate intelligently and efficiently for her own good, — to find such a person at last was a relief which only one who has had the management of a case of this kind can appreciate.

Our ring can now be completed, by substituting Real B for X and the ?.

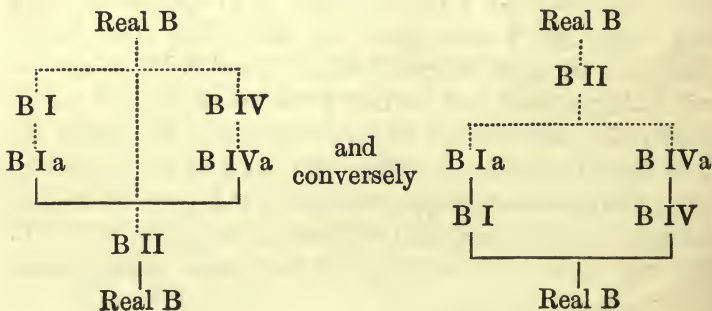

The Real Miss Beauchamp is disintegrated into personalities B I and B IV who, conversely, may be synthesized into Real B. Again Real B may be immediately hypnotized into B II who either wakes to become Real B again, or conversely becomes dissociated into B I a and B IV a.

Also B I a and B IV a may be synthesized into B II, and conversely B II may be disintegrated into B I a and B IV a.

The Real Miss Beauchamp, however, is not permanent. She has the same emotional psychical make-up which is so prominent a trait in I and IV, and though it is not so intense as in the disintegrated selves, still it is sufficient to be a disturbing factor. Daily experiences which in ordinary people would be emotionally colorless are accompanied by feelings of undue intensity. Even memories of the past tend to revive all the original feelings which accompanied them. The mental cohesion of a person with such a temperament necessarily yields to the disintegrating effects of the strains of life. The circumstances of her life are such that it is impossible for her to have that freedom from care, anxiety, and responsibility, in short, from mental and physical strain, that such a nature should have. After continuous exposure to such disintegrating agencies during varying periods, or after exposure to a sudden emotional shock her personality tends to disintegrate once more into its three selves. Then we have played over again the drama of a multiple mental life, and our old friends reappear. Whether or not Miss Beauchamp could be maintained as her real self, stable and permanent, if the circumstances of her life could be adapted to her, instead of the patient's being adapted to circumstances, is a problem which I have never had an opportunity to determine.

The above paragraph was written in December, 1904.<sup>1</sup> In the spring of that year I succeeded in solidifying the

<sup>1</sup> I expected to publish at that time.

real self to such a degree of mental cohesiveness that she persisted unchanged for about two months. Deceived by her buoyant, physical health and apparent permanence, she was tempted, against advice, to undertake new responsibilities that would have taxed the strength of even a strong person. She again broke down and we had once more the old state of affairs with the different selves undergoing the old trials and tribulations in new forms, excepting that *the Real Miss Beauchamp was the most frequent personality*. My 1904 manuscript continued as follows:

“Poor B I, however, has been seen only on few and very brief occasions during the past two years. I understand that she appears at home, more or less frequently, when disintegration is brought about. On the few occasions when I have seen her she has been the same sad, resigned, pathetic figure that she was during the years that she struggled against her fate. Uncomplaining, she simply, patiently, acquiesced in her doom; for in her mind the long periods of amnesia, which cover most of her present life, mean that she is masquerading as Sally or as B IV. When told that she has become her real self, she says that she is satisfied; but it means little to her for she has no memory of and knows nothing of her real self. Practically, the Miss Beauchamp whom I used to know, and whose saintly character was described in the early part of this study, has passed from my view, even if she has not totally ceased to exist.

“Nor has B IV any knowledge of her real self. The periods belonging to the Real Miss Beauchamp are blanks to these other two selves.

“This absence of knowledge of B I and B IV for this real self is worth noting in contrast with the knowledge which each possessed for the various *incomplete* new selves with amalgamated memories, which were created in the experiments of putting I and IV together. (Chapter XXIV.) The resulting personality in most of these experiments, it will be remembered, was not a complete fusion, but was usually recognized as fundamentally either I or IV. On the other hand, when the fusion was complete, B I and B IV had amnesia for that state as they

do now for the Real Miss Beauchamp; and the complete personality obtained at that time was therefore undoubtedly the same as the present Real Miss Beauchamp. The conditions upon which the retention or loss of memory depend are extremely subtle, and we have no data upon which we can base any theory of their nature.

“B IV, I frequently see. She tends to divide the *disintegrated* periods with Sally. She has grown wiser, less aggressive, more ready to accept the inevitable and to settle the problem on a practical basis.

“Sally, too, has matured. She says that ‘People don’t always stay the same age,’ and she would have it understood that she has developed since this study was completed. She claims to have seen the error of her ways, and the wrongness of her points of view, and to have a realization of her responsibilities. She tries to say ‘my’ instead of ‘her,’ to speak of ‘my’ house and ‘my’ book, but has frequent lapses in her phraseology. She also has acquired some knowledge of the French language, and she has partially regained her tactile sensibility.

“As a subconsciousness, she knows too when the real self has sensory impressions, but she acquires this information not through the possession of true tactile feelings, but rather indirectly through the primary personality’s mind. You must not take Sally too seriously. Though she has matured, she is still ‘Sally.’

“Not the least remarkable of the phenomena following the transformation of B I or B IV into the Real Miss Beauchamp is the sudden disappearance of the neurasthenic state. It will be readily understood that when disintegration occurs, neurasthenic symptoms — fatigue, insomnia, and general instability — return. A suggestion of health is given to B II, and, with a snap of the finger, so to speak, she wakes and becomes Miss Beauchamp, buoyant with health. Such experimental phenomena have great significance in connection with the problem of neurasthenia. Neurasthenic symptoms are an expression of disintegration.”

After the break-up in the spring of 1904, it was not possible to make a serious effort at permanent integration

of the personalities until the embarrassing responsibilities unadvisedly assumed had been got rid of and various alterations made in the circumstances of "their" life. This was done in January, 1905. Then once again the screws<sup>1</sup> were turned on Sally, and B II awakened after appropriate suggestions. From that time to the present date (July, 1905), the Real Miss Beauchamp has been in continuous existence, with the exception of a slight lapse on one occasion following a physical illness and other strains. When not subjected to "stress and storm," she describes her health as better than it ever was in her life. At her best she is physically and mentally strong, but she requires a therapeutic suggestion at regular intervals to offset the wear and tear of her life. There is an entire absence of hallucinations,<sup>2</sup> aboulia, amnesia, and other phenomena of dissociation and automatism, but it would not be safe to submit her to strain. The problem still remains, How far and for how long can she be protected?

And Sally, what became of her? With the resurrection of the real self, she "goes back to where she came from," imprisoned, "squeezed," unable either to "come" at will or be brought by command. Automatic writing, speech, and such phenomena cease, and it has not been possible as yet to communicate with her, and determine what part if any she plays in Miss Beauchamp's subconsciousness, or whether as a subpersonality she exists at all. When, however, as a result of some mental catastrophe, she appeared again as an alternating personality, her language implied a persistent existence as a subconsciousness like that of her early youth and as described in the autobiography. Nevertheless the resurrection of the Real Miss Beauchamp is through the death of Sally.

<sup>1</sup> Appendix P.

<sup>2</sup> Excepting on the one occasion of the Christ vision (Appendix L), following five days of anxiety and fatigue.

Since her coming the Real Miss Beauchamp has talked with me during many an hour over her case and about her life. She has not the slightest hesitation in talking about matters which B IV would go to the stake rather than tell. She has told me frankly about herself, her points of view, her attitude of mind, her feelings and emotions when she was B I. She speaks equally freely about herself as B IV. These different states seem to her very largely differences of moods. She regrets them, but does not attempt to excuse them, because, as she says, "After all, it is always myself."

Of Sally, her life, and her doings, she knows nothing, excepting indirectly. Of this part of her mental life she has no more memory than has B I or B IV.





## APPENDICES



## APPENDIX A

TO avoid misunderstanding regarding the meaning of the term "subconscious," attention ought to be called to the limited and precise sense in which this term has been used in this work. The word is used by writers in general with a great deal of looseness, and too frequently its use indicates a lack of precision of thought and often a vagueness of knowledge. But aside from such loose use, though all writers include under the term "subconscious" a coexisting stream of thought, — that is, the notion of *coexistence* of dissociated thought,— others extend the term so as to embrace any dissociated state of consciousness, whether in coexistent activity or not. Thus one competent writer, Boris Sidis, designates as subconscious any dissociated state so long as it is dissociated and whether coexisting or not. "Subconscious" becomes synonymous with "dissociated" and embraces all amnesic states, including the normally forgotten, anything that has dropped out of the memory of the personal consciousness. All past mental experiences, the memory of which is not at the moment in the mind, are regarded as subconscious. An experience that can be recalled if desired, as well as one that cannot be, is defined as being in the region of the subconscious, so long as it is not recalled. Whether or not it is at the moment in actual activity as a co-conscious idea is immaterial. The underlying notion seems to be that all forgotten or other dissociated states not in the focus of attention are potentially capable of being revived, and, therefore, must have at least a potential existence somewhere. It may be desirable to have a term to define all such potentially conscious states, but it does not seem to me expedi-

ent to employ the term "subconscious" for that purpose. I would suggest "*latent* consciousness" as a term which seems to express such states. I have limited the use of the term "subconsciousness" to states which actually co-exist with the primary consciousness, and, therefore, to an extra, co-acting mind of which the primary self is not aware. For an idea to be subconscious, it must be actually in activity, and this means parallelism of thought and doubling of the mind. Unless "subconscious" is used to designate such ideas, it has, to my way of thinking, no special significance. This, it seems to me, is the sense in which the term is used by the majority of workers in abnormal psychology. Another use of the term is to define those perceptions and mental states of which we are only partially aware at any given moment, and which may figuratively be said to lie in the fringe of the focus of consciousness. This, of course, is equivalent to coexistence. After all, it is only a matter of definition, but we must have some term to designate coexistent dissociated thought, and this seems to be the natural meaning of "subconscious;" that is, something that at the moment actually streams under the primary consciousness. A much better term for such thought is, a "co-consciousness" or "concomitant consciousness," but the conventional term has become so widely accepted that the best we can do is to limit its meaning.

## APPENDIX B

ON another occasion, taken at random, my notes record the following order of appearances during an interview:

B IV (hypnotized to)  
B II,  
Sally,

B IV (spontaneous; hypnotized to)

B II,

Sally,

B I (hypnotized to)

B II,

B I,

B IV (spontaneous).

B I and B IV spontaneously would interchange with one another and with Sally, but to make the change by command it was necessary first to obtain a hypnotic state or Sally. Sally too, though spontaneously changing to B I or B IV, could volitionally change herself to either of them only through a hypnotic state, of which there are several. The frequency and variety of the spontaneous changes of personality may be gathered from Sally's accounts (Chapter XX and Appendix K), which tallied with the testimony of B I and B IV and my own observations.

### APPENDIX C

SOME months after this B IV had a spontaneous vision of this same scene. As she described it, I wrote it down as follows:

“On Monday, June 25, while writing a note to Jones, the room suddenly became dark, I became confused, and for two or three minutes, I think, I did n't know anything. Then it seemed to be night; I could see the stars, but the first thing that aroused me was the sound of thunder; I could hear before I could see. The thunder was loud at first, and gradually grew fainter (the storm was passing over); then I saw lightning in the distance, and I saw the stars and the trees. I don't know where I was; it might have been anywhere. If I had n't afterwards found myself in my room I would have believed I had been wherever it was. It was more vivid than many actual experiences; Jones was there. [B IV then went on to describe

the details of the vision, which corresponded in every way to the description given by Sally and B I, but of which IV knew nothing. The language used by the vision actor, and which she distinctly heard, was also the same. IV was still unaware that she was describing a real scene, as she did not believe the crystal vision was a true experience of her own.] My own emotions of fright overwhelmed me and brought me to myself. On coming to myself I was frightened, angry, and impatient. I knew I could n't have had the experience at that time or at any time. There was nothing in my note which could have excited the scene. [About three hours later the vision came again.]”

#### APPENDIX D

**I**N this connection the following statement by B IV (written January, 1900) of certain automatic motor phenomena, which she claimed to have experienced, is not without interest, though from their nature not subject to corroboration. In what consciousness they originated is not clear, though I am inclined to class them with the dissociated states which gave rise to the first group of scrappy memories of the life of B I.

“During the last few months I have had the most curious sort of feeling in talking with or meeting people whom I had previously known. My intercourse with them has been automatic, if I may use the word in that way, as far as speech and action were concerned. I have not known usually from one moment to the next either what I was going to say or do. Very often I have not understood even, but I think people were not conscious of it, at least I could not discover that they were from their expression, although I watched them most carefully to see. (You will understand that I do not include you among these ‘people’—you were too clever for me, and I am afraid always knew whether I spoke automatically with full understanding, or simply in a sort of guessing way. It was n't quite fair of you, I still think.) But though word and

deed have seemed automatic and as a rule quite beyond my control, feeling and emotion have not been so at all. And this is very curious to me, for you can see how contradictory it is. Naturally one would expect that one's words and deeds would be simply the expression of one's thought and feeling, and that if one were conscious of thinking and feeling, one *must* understand one's own speech and action. Yet I have not, except very rarely. I am constantly referring to incidents which I do not remember; that is, which I am not conscious of remembering, and writing to people whom I do not know, often in a most familiar and intimate strain.

"Perhaps my choice of the word 'thought' in trying to explain this is not a good one. In fact I know it is n't, but I do not know what word to use. In one sense I do think, but not very clearly or coherently. It is perhaps as if my earlier ( $H_2$ ), intermediate (S), and later experiences ( $O_4$ ), instead of uniting to form one ( $H_2S O_4$ ), were still" [interrupted by Sally, who confiscated every scrap of paper].

"Amen. Amen.

"She is n't a person, Dr. Prince, and I won't have it. I hate them all and I hate everybody, but you may have this stuff. It's more stupid than the auto papers I've written. Turn about, you know, and I might throw this on the fire [referring to IV's destruction of the 'auto']. I don't believe a word of it."

## APPENDIX E

THE following interrogatory, taken from Charcot's account, gives an idea of this amnesia:

Q. Do you know R——, Madame?

A. No, sir, I have never been there.

Q. Has your daughter taken any prizes this year?

A. I do not know.

Q. Do you remember whether, in the month of August, a person falsely announced to you the death of your husband?

A. I have never heard anything of the kind.

Q. What is that wound which you have on your right hand?

A. It is a burn.

- Q. When and how did you burn yourself?  
 A. I know nothing about it.  
 Q. Might it not be the bite of a dog!  
 A. I have never been bitten by a dog.  
 Q. Have you never seen Paris?  
 A. No, sir.  
 Q. You have never seen the Eiffel tower, the Louvre?  
 A. Never.  
 Q. Do you know the Pasteur Institute?  
 A. Yes, by name; I have never been there. It is in Paris.  
 Q. Where are you now?  
 A. I do not know; I do not know this room.  
 Q. Do you know the Saltpêtrière?  
 A. I have never seen it, but I have heard it spoken of.  
 Q. Do you know these two ladies (the two women occupying the adjoining beds)?  
 A. No, sir, I have never seen them.  
 Q. And this gentleman (M. S —, house-officer)?  
 A. Not at all.  
 Q. And I, do you know me?  
 A. (After a moment's thought) — *Yes, you are M. Charcot; I am, then, in Paris.*  
 Q. Have you breakfasted this morning?  
 A. I do not know; I must have breakfasted, for I am not hungry.  
 Q. Who brought you here just now? Where did you come from?  
 A. I do not know.  
 Q. What day is it?  
 A. Oh, sir, I know neither the days nor the months; I know not how I live; I am most unhappy.  
 Q. What did I just ask you?  
 A. I have forgotten already; I do not know. . . . I have tried hard to think, I can't recall it."

Contrast the following interrogatory, made during hypnosis, with the preceding:

" Q. Madame, do you know R — ?

A. Yes, sir. I was there on the seventeenth of August last



with M. and Mme. V. We visited the Park, and the Casino; I saw in the Park a woman who was playing "au sabot," and who had lost 500 francs. In the evening we were at the theatre, and we did not return to C—— until the noon train on the following day.

Q. Has your daughter taken any prizes this year?

A. Yes. She has had three: one for reading, one for writing, one for spelling, the first I believe.

Q. What occurred at your house on the 28th of August?

A. I had just left Mme. V.; I was about to stitch an apron on the machine, when a man whom I do not know entered and said to me abruptly: 'Your husband is dead, they are going to bring him to you; get the bed ready, Madame D.' He must have known my name. I was so affected that I suddenly dropped; my head struck against the needle-carrier of the machine, making a small wound which troubled me for many days. Then I felt this man tap me upon the shoulder, saying, 'Instead of lamenting, go up stairs and get the bed ready.' Then he went away, I do not quite know how, I was so overcome.

Q. And the story of the dog?

A. It was the 30th of October, Friday, at 9 o'clock in the morning. I was on the S—— road. I was looking for a lodging; a little yellow dog bit my hand and tore my dress. A lady came to my rescue and said that I ought to be cauterized, as there were mad dogs in the town. I wrote that in my notebook. I was burned with alkali, then with the thermo-cautery.

Q. When did you come to Paris?

A. I came to Paris on the 5th of November with my husband; we stopped at the house of M. L——, rue de l'Odéon. Every day for fifteen days we have been at the inoculations at the Pasteur Institute, etc.

Q. Who are these ladies?

A. They are my two neighbors in the ward; they came just now to the parlor with me. They are at 16 and 18 in the Cruveilhier room. They are Mme. C. and Mme. X.

Q. What day is it?

A. It is Tuesday, the 22d of December."<sup>1</sup>

<sup>1</sup> Revue de Médecine, Paris, XII, pages 91 and 95.

## APPENDIX F

SALLY'S account of the method by which, as she maintained, she subconsciously interfered with IV's vision, is as follows. The credibility of such accounts, of course, must be weighed in connection with all the other subconscious phenomena observed. The facts were that IV had taken a tumbler and using it as a "crystal" to obtain a vision of her stay in the private hospital, had seen the wrong room and Dr. S., who once had attended Sally and B I in another hospital; but he was unknown to IV, as this was before her advent.

"Sally was curious, as she always is, to know what B IV was going to do next. It took but a moment to jump to the conclusion that what B IV wanted to find out was what happened in the private hospital where she had been as B I. This intention was easily guessed from the fact that B IV had just been writing something about her stay there, and incautiously gave herself away by interrupting her writing to look into the glass. So Sally proceeded to muddle her up. 'She had been trying to get you [in a vision],' said Sally, 'so as to learn about you; she got the hospital, but I made her see the wrong room. She 'fixed' her mind and I 'fixed' mine. I thought very hard about the front square room [Miss B.'s was a small back one] and I thought Dr. S. would look well in it instead of you. So I thought of him as I saw him in the . . . Hospital. No, I did n't think about his position in the room, or place him in any particular relation; I thought of the room as it looked on a particular morning, in a general way, but not that the bed was here and the chairs there, but I thought of Dr. S. and the room together. B IV saw Dr. S. in the wrong room. She did n't see it as in a vision, but she saw the picture of the room projected against the wall of her own room, and saw both at the same time, so that the picture was n't vivid as in a vision, but shadowy; but she saw the features of Dr. S. She does n't

know what to make of it, because she does n't know Dr. S. and does n't know what he was doing in the hospital."

B IV confirmed the correctness of the facts of her hallucination.

## APPENDIX G

**T**HIS incident was of the nature of a personal observation, the phenomenon having been actually witnessed.

Hypnotized B IV had been brought by metamorphosis from hypnotized Sally; that is, the change was from one hypnotized state to another. The apparent effect of this method was that the resulting hypnotic state was not fully developed but was "rattled," as Sally used to call it. Perhaps it was rather that B IV went back in her mind to an earlier period of her life. At any rate, she did not realize where she was (her eyes were shut), and mistook me for some one else. She addressed me by the first name of this person. When told to give the last name she showed signs of responding, but immediately became dumb. She could not articulate a single word. The expression of her features indicated fright. It was plain that, realizing that she had been stricken dumb, she was seized with fear. She put her finger to her lips and made signs to indicate that she was dumb. Her alarm increased. She kept touching her lips and tongue with her finger to show me her anxiety over what had happened. While I was assuring her that there was no ground for alarm, Sally suddenly emerged from her Bastille, laughing heartily.

"I stopped her," said Sally, and then added, with some feeling, "She sha'n't tell, and I shall stop her if she tries. I held her tongue. She was frightened because she could n't move it. I shall do it again."

Even if one feels obliged to doubt Sally's boasted power, the fact that B IV was stricken dumb by some internal force is beyond question.

## APPENDIX H

THE following was personally observed. It had been arranged with Sally that as soon as she should change to B I or B IV, pencil and paper should be given to whichever it was, and while this one was engaged in conversation, she (Sally) "inside," as a subconscious self, without the waking person's knowledge, should write a message and should answer such questions as were put to her. The experiment was to be conducted in the usual way in which such experiments are done. If all had gone as arranged, the observed phenomena would not have been the spontaneous action of the subconscious on the personal consciousness, but only an artificially induced dissociation of consciousness, together with phenomena akin to post-hypnotic suggestion. But that is not what happened.

After making the arrangements B IV was obtained. She agreed in her turn to the trial. Seated before me, in her hand a pencil which rested on a sheet of paper, she went into a state of abstraction, but the hand refused to write. I was beginning to think that Sally was really unable to fulfil her end of the bargain, and took the pencil to write a question, when, abruptly and violently, the hand seized the pencil out of mine and threw it across the room. B IV, in her state of abstraction, was unconscious of the action. Recovering the pencil, I wrote the question; but now *B IV was unable to see the pencil or the writing*. She was taken, for the moment, with negative hallucinations. I insisted on the visibility of the writing.

"I see you making motions on a blank sheet of paper, as if writing," she explained, "but you don't leave any marks."

That was all that could be accomplished.

"I can make her not see things, or see things," Sally boasted a few minutes later; "I made her see snakes once."

Here was not only "automatic" motor action, spontaneously produced by volitional subconscious states, but systematized anesthesia also.

## APPENDIX I

SALLY conceived the idea that if she could only read French and know as much as the other personalities, she would not be looked down upon as "nothing but a subliminal," but would be held in equal esteem and be allowed to stay. She had "just as much right to stay as they had," she often repeated. At any rate, if she could n't read French they should n't. So much by way of explanation.

I was desirous of testing the Idiot's field of consciousness, and, in particular, of determining whether a knowledge of French was still within it, or whether it was only within that of B I. B IV had said that she could read French, but when offered a French novel she declared it was nothing but a blank notebook. Her manner at once changed to offended dignity. It was a practical joke that was being played upon her, she insisted, and her manner plainly showed that she considered it a discourtesy. It was in vain that I disclaimed the discourtesy and insisted that the pages were not blank, but French text. Finally, after much insistence, I said, "If you won't believe me, go pick out a French book from the bookcase." She then saw no bookcase at all and no books, but declared, in spite of every assertion on my part to the contrary, that it was a blank wall sheathed with wood panels, as was the other side of the room. Thinking the tactile sense might correct the visual hallucination, I bade her feel the books with her hand and convince herself. The bookcase was in a recess

between the chimney breast and the end wall of the room. She placed her hand in mid-air on an imaginary line running across the recess from the chimney-piece to the end wall, about twelve inches in front of the books. She insisted that the wood panels ran across the recess at the site of her imaginary line. I rapped on the books, thinking that the sound would enable her to distinguish the books from her hallucinatory panelling, but she explained the sound in an ingenious way. I then made an effort to force her hand against the books and past the imaginary line, but she resisted the force by muscular counter-effort. There was both a positive hallucination and a negative one, the former being the wood panel which was not there.

All this, of course, increased her sense of discourtesy, and I could only insist she was mistaken. There was a twinkle in Sally's eye when she was asked later if she could explain these hallucinations. "No, it is a mystery," she replied. A few days later she confessed her part in the trick, adding, "The Idiot sha'n't do anything that I can't do. She sha'n't read French. She may at home, but she sha'n't here." Sally further claimed — a point of importance — that she caused only the negative hallucination and had nothing to do with the positive hallucination, — that of the wood panel. This latter, then, was the logical expression of B IV's belief that no bookcase was there.

## APPENDIX J

**P**HENOMENA similar to the following have been observed on numerous occasions. B IV, who had been "scraping" with Sally, suddenly, while describing the events of a morning, stopped abruptly, unable to go on.

[Notebook.] "She exhibits evidence of inward struggling. She has a distinct attack of aboulia, but manages in a disjointed

way to explain: says she can't go on; her mind won't work; she can't explain now; will write it later at home. In answer to questions, shakes her head, and puts her finger to her lips; does n't feel as if any one were stopping her, but can't explain; begins to stutter, and exhibits great difficulty in talking; becomes angry, saying 'I *will* talk, and I *won't* stutter.' 'I never st-st-stuttered b-b-before in my life t-t-till lately, and only occasionally now. I th-th-think it is p-p-perfectly horrid.' [Here she becomes absolutely dumb.] I urge her to write. She takes the pen, but cannot. Then she bursts out angrily, 'I won't be controlled!' Then presently, 'I can't go on now. It makes me nervous, — this sort of thing. It makes me so angry. It is the same way when I want to do things — not to be able to do or think [makes me feel this way].' Finally, after a moment's silence, she begins to speak, with a sort of explosion of will force, stuttering, and speaking all in a breath, as if bound to speak in spite of some kind of control. After a successful effort she exclaims, 'There, I will tell you if I want to!' (This with vehemence, as if she had conquered some one.)"

## APPENDIX K

SALLY'S account of events of Thursday, March 6, 1902, at the time of Prince Henry's visit to Boston:

"If you won't let me do anything and B IV or V sticks to her good resolutions there won't be any sort of a record for you — not any sort of an *interesting* one. It will be like this —

"One o'clock, B I eats; two o'clock, II sleeps; three o'clock, III opens her eyes (me, you know); IV comes at four o'clock, and V, at five. You see how stupid that all is. J. is n't in it, or Anna; nobody nice but you.

"Yesterday's record: II would n't wake up when the soldiers came, so I had to rub my eyes a long while to come myself. I wanted to see them and it was almost seven o'clock, quite time to get up, was n't it? You are n't cross about that — Then after my bath and breakfast I started for your house, but IV came

on the way there — or V<sup>1</sup>; perhaps it was V, for she said good-morning to you in the hall where she was petting the dog, and then afterward, when you came into the office, she said good-morning again, don't you remember? quite as if she were seeing you for the first time. B I came while she was at lunch — you don't care anything about her thoughts, do you? She finished her lunch and then, after looking at the clock to find if the prince had gone, she started over to call on Mrs. T., an old lady who is paralysed and all that, but awfully devoted to C. Then she came home and hunted everywhere for her sewing — what IV calls the heathen sewing and stuffs into corners. She found it finally and set off for Mrs. X. with it, intending to bring back some more. You *don't* care about her thoughts, Dr. Prince, do you? They are always the same, and always tiresome. Mrs. X. was delighted, apparently, to have her offer to take more things, but I could n't help being awfully amused when I thought of what IV would say to me when she saw them. Mrs. X. made B I promise to go to bed very early, for she thought her looking tired, and she gave her tickets for some concerts and for the portrait thing and smiled on her, so that B I came away happy. She told Mrs. X. a lie once — a deliberate lie — and she thinks it was right for her to do it, but I notice her conscience pricks her occasionally. It did yesterday. After leaving Mrs. X. she trotted back to the old lady again with her sewing, and made little shirts until dark. Then I came, then IV, then I, then B I, and then IV again, just while she was eating dinner, then B I, then B I went to see Miss F., who is ill. IV came while she was talking, and almost immediately got up to go; then IV stayed all the rest of the evening, but she did n't sew and she did n't go to bed early, as B I had promised to do. She got Mr. B., who came in, to talk to her instead, and after he had gone she shampooed her hair, bathed, scolded me because she had missed the prince — she certainly saw him, or V did; she told Mr. B. she saw him twice. She was terribly restless after going to bed — tossing and twisting and turning all night long. She told you that she did n't sleep, but she did a little after it grew light this morning.

<sup>1</sup> Intended for one of the new personalities described in Chap. XXIV.



“ I shall have to finish this to-morrow. *Do* I write too much? none of it is interesting now, I know, but you must tell me what to leave out. IV has come several times since I began this, but she has n't said anything except that I'd better not use both sides of the paper, and that my real age was probably, yes undoubtedly, ninety-nine. I think that is a very silly statement to make, and it has n't any point.

“ S. B.”

[March 9, 1902.] “ I'm so glad you liked the letter. I think it was very stupid. Friday is an awfully hard day to tell you about, for I don't more than half understand it myself. In the first place, you know IV was horribly fidgety and nervous in the morning through not having slept. Then she got cross because just after she had taken her bath B I came and took another. Then B I put on the wrong clothes, and that made her crosser. She thought I was doing it, I suppose, although for a wonder she did n't scold me. They had lots of trouble dressing and getting started for your house, and after IV got there she hunted all through the papers, the drawer, her pockets and clothes for something. I'm sure I don't know what—she did n't find it, at any rate. Then she got the papers to work with, but instead of working she sat on the radiator and gazed into space. . . . B I was horrified of course, and got down, but she was frightened too for fear you would come, so that she was all dead in a minute or two and IV came again. Then IV put the boxes away and started for Cambridge. I can't tell you much about it. She did n't see——she did n't see him about any letters. She did n't have a vision of you in his presence. What she did do was to ride as far as Harvard Square and then get off to go toward the check man, or whatever you call him, to get a ticket for another car. It was then that I made her see you, or tried to. She stepped back in a bewildered sort of way, hesitated a moment, and did n't take any check. Instead B I came and being fearfully distressed to find herself there—she did n't like Cambridge—got on the first car that came along and returned to Boston. She forgot to get off at——Street and was carried way down town. I'm afraid you won't like this account of what happened at Cambridge because you

believed B IV, but this is the true one. I can't explain what she says in any way but this — that she had anticipated in her mind what would occur when she met — (B I often does), and that you appeared in her dream surroundings instead of in the actual ones. Perhaps she was lying — I don't know; you must determine that for yourself. It is so hard not knowing her thoughts and she will never admit *anything*.

“After lunch C. carried her old lady down to White's, then home, and promised to come back, *if* she could, for the afternoon with her sewing, — the heathen sewing, you know. Then on the way home IV came and seemed fearfully upset, so I thought she'd better see you. I did n't think the vision would have frightened her so, but I'd rather she would be frightened ten times worse than to make trouble for — . Please don't be cross, though you know all about Friday afternoon.

“In the evening she wrote to you — then rolled herself up in wet towels and laid down on the couch. Then I came and wrote you, you know, and afterward went to bed — about ten o'clock. I tried to get B I because I wanted her, but the first thing that she did, as I might have known she would, was to get out of bed and look for her sewing. She's always thinking that *some* day IV and I are going to be nice. She was much grieved to find that we had spent the afternoon and evening differently from what she had planned. You know she was preparing for Mrs. T.'s when she disappeared. Nothing particular happened Friday night. C. slept better than the night before, although she was restless and kept talking and gritting her teeth. I tried two or three times to get my eyes open to see something outside, but I could n't. I could n't move any part of her. In the morning IV, or V, was here again, and she laid in bed for a long while thinking about something. I do wish I knew what, for I'm sure it was interesting. Miss K. came while she was taking her bath to get her to go to some meeting in the afternoon, and IV promised to go. Miss K. is in love with somebody else now, and very rarely comes over. Then Miss F., the pretty girl, came, and she and IV talked, and talked, and talked until lunch time; and IV — it was too funny for anything — fished out B I's little shirts from behind the bookcase, where she had stuffed them in a rage, and showed

them to Miss F. as *her* work. Why, Dr. Prince, there is n't a bit of them hers — not a single stitch. After lunch B I did one or two errands, called for Mrs. T., and took her home. Then she kept changing every minute or two until she met Miss K. The meeting was a mistake — the Grundmann meeting, I should have said — so that B I rushed off home to sew until four o'clock when she promised to go down town with Miss K. to do some shopping. Mr. N. was here when she got home, and B I was troubled by his manner which seemed rather cold (IV does n't like him and has been snubbing him. He thinks he has been deceived in B I, fancies her less unworldly than she posed as being in the first of their acquaintance). B I dismissed him at four o'clock, did the shopping with Miss K., had dinner, and came home to [I spread over so much paper perhaps IV's record *is* better] sew, but then IV appeared again, and skipped over to Miss F.'s house. She's (IV) awfully afraid of the dark. Afterward Mr. B. came, and B I sewed, with interruptions, until eleven o'clock. Mr. B. likes IV not B I, but B I was very nice last night and they seemed to get on well enough. IV makes him tell her everything, and he is very bright and amusing then. B I would rather talk to deaf old ladies and dirty little ragamuffins than to listen to really interesting people. I like Mr. B. too. I'm not going to write any more now. I want — back again. I want him awfully, for he's always nice to me, and he knows so many things to do. What is your kingdom?<sup>1</sup> What is half of it? Please give it to me now. Last night and to-day are going to be very hard to write; they are all mixed up. Can't I skip them and begin with some time next week?

“S.”

[March 10, 1902.] “You did n't say whether I could skip Saturday night and Sunday and begin somewhere else. Please tell me. I can't make very much out of the book incident myself — or rather, what I do make out of it can't possibly be true. A long time ago B I heard of the Baroness von Hutten's book and, seeing one of them in your Library, took it home to read — the

<sup>1</sup> Referring to a jesting offer to reward her if she would write out these accounts.

“Marr’d in Making” you know. I hope you may have read it too, else you won’t understand very well what I’m going to say. B I found the book — found Beth at least an utterly incomprehensible creature, and had several discussions about it with Miss L., that vivacious French woman, you remember? C. was impressed by what Miss L. said, and rather shaken in her convictions, so much so in fact that she re-read the book a chapter at a time, making certain critical notes as she went along. Then she had another talk with Miss L., which ended by Mademoiselle telling her that she had no doubt whatever about Beth being drawn from life — she had known dozens of girls like her — but she realized the utter impossibility of a nature like C.’s being able to see that. She said that very likely C. would not recognize her even if she were living in the same house with her; and so on. C. remained unconvinced, although she said very little. I know that she was perfectly sincere in this discussion — perfectly. Now IV.

“Interrupted by Mr. N.; he has been here for two hours, watching IV’s poses. I’ll write it out for you later. I want to finish this now.

“IV stumbled across the book by accident a few weeks ago and read it through at one sitting. She seemed very much interested in it, but I paid no particular attention until she asked Miss F. about it and got her to read it. Then I was simply astounded to hear them comparing notes of their own experiences with those of Beth’s. They thought Beth ‘most wonderfully interpreted,’ they ‘understood exactly how she felt in the presence of any real emotion or feeling,’ and they sympathized deeply with her in her efforts to avoid such scenes. At the time I thought B IV was saying all these things for effect, to draw out Miss F. I wondered why she should tell so *many* lies.

“One would have been enough — just to say that she thought the book good. Now, however, I am not so sure she was lying. It may be that she really does understand Beth as one akin to her, and that she would rather be like that than B I. Do you think so? I could tell you heaps of things, if it did n’t take so long to write them, which, apparently very puzzling,

could be explained very easily if this Beth thing were true. And yet how can it be true? B I can't be something or somebody whom she does n't in the least understand. Can she, Dr. Prince? Do you know? And yet, one might say, how can C. (IV) talk glibly of things which C. (I) has never *consciously* heard or known, certainly never thought upon?

"I have n't got any where in this letter, I know. All the little pieces need to be brought up, but I don't feel like writing any more. It's the *very stupidest work*. IV is terribly distressed about something (I don't believe it's —), for she actually cried this evening, pressing her side as if it hurt, and finally taking a powder and some hot lemonade for it, or for me — to fool me, you know. She was too funny with Mr. N., but of that later."

A letter from Sally describing her lack of power over a fused personality who had the combined memories of B I and B IV. This fusion was brought about artificially and will be described in Chapter XXIV. It will be noticed that Sally writes as if she were still a persistent sub-consciousness, as she was before she "got her eyes open":

"Is C. going to be always herself now? Always strong mentally, I mean, so that no one can make her do things but you? I tried yesterday, and to-day too; first for the sake of an interesting experiment, you know — not to tease her — and I could not make anything go. I thought it would be *very easy*, and I began with a nice little gray mouse, which she saw just for a second, but not half long enough to make it worth while. Then I tried J —, three times, in the most appealing attitudes you can imagine; and you, and a procession, and then the mouse again, and nothing made any impression upon her. She went back to you every time. Is she going to do that now? It was just the same to-day when I tried to make her walk, when I salted her lemonade, and when I tried to prevent her reading B I's paper. I call it very tiresome if I'm not going to be able to do anything more than I used to before I got my eyes open. I should think you'd *want* me to stay and tell you things. When I've written out the nights for you

are you going to drop me and just have C. all the time? Is n't there going to be anything else you want me to do? I think I'd rather do psychological things than *never, never* talk to you. Why, I thought it would be so terribly easy to make experiments with C. now, because she *is* confused, although she has both I's and IV's memory, and being confused, it ought to be easy enough to rattle her still more. And it would be — really it would, were it not that I run up against you every time.

“When IV does come back I've got loads to tell her. Is n't she coming back? Please, Dr. Prince, tell me what you're going to do. Are you going to try to mix me with IV and I? because you can't possibly. And are you going to tell them I'm a subliminal? because I'm not; and are you going to drop me when I finish the nights for you?

“Yours.”

## APPENDIX L

MISS BEAUCHAMP as a child frequently had visions of the Madonna and Christ, and used to believe that she had actually seen them. It was her custom when in trouble, if it was only a matter of her school lessons, or something that she had lost, to resort to prayer. Then she would be apt to have a vision of Christ. The vision never spoke, but sometimes made signs to her, and the expression of his face made her feel that all was well. After the vision passed she felt that her difficulties were removed, and if it was a bothersome lesson which she had been unable to understand, it all became intelligible at once. Or, if it was something that she had lost, she at once went to the spot where it was. On one occasion when she had lost a key, her vision of Christ led her down the street into a field where under a tree she found the key. She constantly used to have the sense of the presence of some one (Christ, or the Madonna, or a Saint) near her, and on the occasion of the visions it seemed simply that this person had become visible.

On the night of the very day when the account of her early visions was given me by B II and confirmed by the Real Miss Beauchamp, the latter had a vision of Christ which I was able to investigate. Miss Beauchamp had lost a bank check and was much troubled concerning it. For five days she had made an unsuccessful hunt for it, systematically going through everything in her room. She remembered distinctly placing the check between the leaves of a book, when some one knocked at her door, and this was the last she saw of the check. She had become very much troubled about the matter, and in consequence after going to bed that night she was unable to sleep, and rose several times to make a further hunt. Finally, at 3 o'clock in the morning, she went to bed and fell asleep. At 4 o'clock she awoke with the consciousness of a presence in the room. She arose and in a moment saw a vision of Christ, who did not speak, but smiled. She at once felt as she used to, that everything was well, and that the vision foretold that she should find the check. All her anxiety left her at once. The figure retreated toward the bureau, but the thought flashed into her mind that the lost check was in the drawer of her desk. A search, however, showed that it was not there. She then walked automatically to the bureau, opened the top drawer, took out some stuff upon which she had been sewing, unfolded it, and there was the check along with one or two other papers.

Neither Miss Beauchamp nor B II has any memory of any specific thought which directed her to open the drawer and take out her sewing, nor of any conscious idea that the check was there. Rather, she did it, so far as her consciousness goes, automatically, as she used to do automatic writing. B II, however, was able to give facts which make the matter intelligible. Miss Beauchamp remembers distinctly putting the check in a book, but B II says that she did not actually do this. She held the book in one hand

and the check in the other with the full *intention* of placing the check in the book, but at this moment a knock came at the door. Thereupon she laid the book and check upon the table. After answering the summons at the door she went to the table and picked up her sewing, and unconsciously, at the same time, gathered up the check and the other papers in the folds of the stuff, and folding the whole together placed it in the bureau drawer. B II remembers distinctly each detail of the act, but Miss Beauchamp cannot recall it even now after being told of it. (This memory involves the action of the secondary consciousness, which we shall later study). Miss Beauchamp's real memory ceases with the intention, and the latter afterward became evolved into a delusional memory of having carried out the intended action. A delusion of this kind is quite common in normal people, and I suppose most people have experienced it.

It is pretty clear, then, that the finding of the check in this case was accomplished automatically by a subconscious memory of Miss Beauchamp's act of putting it away, and that the vision of Christ was the resuscitation of an old automatism, under the influence partly of this subconscious memory, and partly of the suggestion derived from our conversation about some visions of her childhood held a few hours previously.

Visions like those of Christ and the Madonna, which express the conscious or the subconscious thought of the individual, are very common in religious history. From the point of view of abnormal psychology they are all to be interpreted as sensory automatisms of which the genetic factor is the person's own consciousness. (See Chapter XXXI.) The part played by the secondary consciousness in solving the problems of her school lessons will be in itself an interesting subject for later study. (Part III.)



## APPENDIX M

**J**AMES' account (p. 223) of the Ratisbonne case, somewhat abbreviated, is as follows:

“The most curious record of sudden conversion with which I am acquainted is that of M. Alphonse Ratisbonne, a free-thinking French Jew, to Catholicism, at Rome in 1842. In a letter to a clerical friend, written a few months later, the convert gives a palpitating account of the circumstances.

“The predisposing conditions appear to have been slight. He had an elder brother who had been converted and was a Catholic priest. He was himself irreligious, and nourished an antipathy to the apostate brother, and generally to his ‘cloth.’ Finding himself at Rome in his twenty-ninth year, he fell in with a French gentleman who tried to make a proselyte of him, but who succeeded no farther, after two or three conversations, than to get him to hang (half jocosely) a religious medal round his neck, and to accept and read a copy of a short prayer to the Virgin. M. Ratisbonne represents his own part in the conversation as having been of a light and chaffing order; but he notes the fact that for some days he was unable to banish the words of the prayer from his mind, and that the night before the crisis he had a sort of nightmare, in the imagery of which a black cross with no Christ upon it figured. Nevertheless, until noon of the next day he was free in mind and spent the time in trivial conversations. I now give his own words.

“ . . . Coming out of the café I met the carriage of Monsieur B. [the proselyting friend]. He stopped and invited me in for a drive, but first asked me to wait for a few minutes whilst he attended to some duty at the church of San Andrea delle Fratte. Instead of waiting in the carriage, I entered the church myself to look at it. The church of San Andrea was poor, small, and empty; I believe that I found myself there almost alone. No work of art attracted my attention; and I passed my eyes mechanically over its interior without being arrested by any particular thought. I can only remember an entirely black dog which went trotting and turning before me as I mused.

*In an instant the dog had disappeared, the whole church had vanished, I no longer saw anything, . . . or more truly I saw, O my God, one thing alone.*<sup>1</sup>

“ ‘Heavens, how can I speak of it? Oh, no! human words cannot attain to expressing the inexpressible. Any description, however sublime it might be, could be but a profanation of the unspeakable truth.

“ ‘I was there prostrate on the ground, bathed in my tears with my heart beside itself, when M. B. called me back to life. I could not reply to the questions which followed from him one upon the other. But finally I took the medal which I had on my breast, and with all the effusion of my soul, I kissed the image of the Virgin, radiant with grace, which it bore. Oh, indeed, it was She! It was indeed She! [What he had seen was a vision of the Virgin.]

“ ‘I did not know where I was : I did not know whether I was Alphonse or another. I only felt myself changed and believed myself another me ; I looked for myself in myself and did not find myself. In the bottom of my soul I felt an explosion of the most ardent joy ; I could not speak ; I had no wish to reveal what had happened. But I felt something solemn and sacred within me which made me ask for a priest. I was led to one ; and there, alone, after he had given me the positive order, I spoke as best I could, kneeling, and with my heart still trembling. I could give no account to myself of the truth of which I had acquired a knowledge and a faith. All that I can say is that in an instant the bandage had fallen from my eyes ; and not one bandage only, but the whole manifold of bandages in which I had been brought up. One after another they rapidly disappeared, even as the mud and ice disappear under the rays of the burning sun.’ ”

## APPENDIX N

**T**HE following is an extract from a letter which was drawn forth in explanation of certain complications that had arisen. It was written by the New B IV, with the memories of B I and IV, and shows the interchanging of the personalities, and their methods of mutual co-operation as well as antagonism.

<sup>1</sup> Italics are mine.

“About three or four weeks ago Sally evolved a certain scheme . . . and on the strength of it obtained my [IV] permission to invite a friend to visit me for a couple of weeks, beginning the first of June. This friend, I should say, is exceedingly distasteful to me [as B I], and in inviting her I [IV] realized it and knew that I was risking a great deal. I knew that it would mean constant evasion, shifting, and fencing, with always the chance of an utter break-down as [B] I. But the risk appealed to me [IV]. I craved the excitement of it, and felt, too, that knowing me as slightly as this girl does, she would not find anything very extraordinary in my behaviour, provided Sally, by threats, etc., kept me [as B I] in order.

“Please do not misunderstand, Dr. Prince, and think I am blind to all the horrid side of this. I am not indeed, but only by giving it all to you can I hope to make things clear, or look for you to help me. And I need help — awfully. I am fast getting into the same nervous condition in which I was last year at the end of my trip with Miss K. Only this time it is worse, for it is present whether I am B I, IV, or wholly myself. Last year it was not so, I think.

“The girl came, and things went smoothly enough for the first two or three days, as Sally wrote up for me [IV] at night everything that it was necessary for me to know. I [B I] did not appear at all, although I had been warned by myself [IV] in a letter of this girl’s coming and knew what was expected of me. That is, I [B I] knew that unless I did as I [IV] thought best Sally would tell me [IV] of all my shortcomings, and I [B I] would be made to repent them. But I think it was about the third day of T.’s visit there began to be difficulties. Sally refused to give up half the money as she had promised me [IV] she would do, and, not only that, she refused to answer any questions concerning it. This made it *inexpressibly* difficult for me. Everything T. proposed had to be vetoed while the struggle was going on. I could not walk or ride, see or be seen, meet her friends or mine, or in fact do a single thing she wished. Naturally, the girl did not understand; she felt hurt and disappointed, and seeing this made things ten times worse for me. I [IV] sat up all night long trying to reason with Sally. I [B I] hunted everywhere for the money. Then I [IV] fought. Sally

threatened to make me [IV] 'dead' and bring I. She succeeded for a time. I became B I, but things were no better, for, as I told you in the beginning, this girl is exceedingly distasteful to me as B I. Not only that, I cannot—strange as it seems now—understand her in the least. I cannot talk with her, and all that she says is strange and foreign to me, — our points of view are so entirely different. Nevertheless, I [B I] tried feverishly to keep up with her and to be nice to her, knowing very well what would happen if I did not. But, Dr. Prince, that sort of thing is not easy for me as B I. I do not think I deceived the girl for an instant. She knew that something had changed me, and that I, as I sat there listening, did *not* like her. And I knew that she knew.

This has been going on for about two weeks now, and will last for about two more, — until the twenty-sixth. You have no idea how great the nervous strain upon me is. And there is *no* way of lightening it except by using force to make Sally keep her word. I am unwilling for certain reasons to have you do this. But if you will only help me to hold out until the end of this month, if you will only help me to keep my mind clear, to stay myself, to have courage, to believe in the future, I shall be forever grateful to you."

The following letters let the difficulties of management be seen:

[From B IV.] "I am expecting to be at the office from eleven until one every morning this week except Saturday. If it is convenient for you to come there, I need hardly say — after my letter — that I shall be awfully glad to see you. I think I have never in my life felt quite so helpless, and so at a loss to know how to move."

[P. S.] "*Please, please* don't come, Dr. Prince. Tell her it is n't convenient, or that you're going to China, or *something*. I don't want you to come. *I don't want you to.* I will answer your letter to-morrow, perhaps. I can't now, for I'm going out. Please stay in Newport. It is terribly hot here, and you know

B IV is *always* horrid — *always* — there would n't be any use in your coming. Yours sincerely,

“S. B.”

“I know lots of things about B IV that she does n't know. *Don't you tell her though.*”

[From B IV.] “Can you forgive me? I have only just discovered that the letter to which I supposed yours was an answer never reached you! What you did receive must have been some invention of Sally (or the devil?) worded in such a way as to mislead you. My own letter, with the details which it annoyed me so to have you ignore, came to light this morning, together with several letters written apparently by B I. I need not trouble you with them now. I only want you to know that I am sorry to have misjudged you.”

[P. S.] “Why do you want to see her, Dr. Prince? She's cross about —. That's all. She does n't want to see him, or speak to him, or even write him. And she must, for he's *very* lonely, *very, very*. Please stay in Newport a little while longer. You will, won't you? Nobody is in town now, and Mrs. P. wants you there with her. Are you cross with me now? Please don't be.”

[Aug. 27, 1900.] “Please come, dear Dr. Prince. I want you *so much*. I can't make B IV go, nor B I. . . . Everything is wrong here. *Come, please!*”

“SALLY BEAUCHAMP.”

[Two days later. Aug. 29, 1900.] “I won't do *anything* for you. So. S. B.”

“And you can't see B IV nor B I. I shall write them.”

[Two days later. Sept. 1, 1900.] “. . . When are you coming back? I thought you said it would be yesterday. And when do you want me to write the summer auto stuff for you? I want you to come back. Only please don't be cross with me when you come. Everything is in a dreadful muddle here, but I can't help it. . . . J. does n't scold me, you know.

“S. B.”

[From IV, Sept. 1, 1900.] “. . . From your beginning to hypnotize me last Friday until your coming to-day I remember but two things: One, leaning forward in a carriage in order to read a note (Sally’s) by the light of the street lamp. The other, tearing off a lot of coverings (flannel, etc.) which seemed to be burning my chest. Neither of these things could have occupied more than five minutes at the very most, and all before and after, until your coming, is blank. Can you wonder that I was surprised to see you? puzzled to know what had brought you? and bitterly, *bitterly*, disappointed that you should have failed again in your attempt to help me? I was rude, perhaps. I seem to be always that with you. But you do not know how very hard I find it to understand you. One should have learned something in a year, yet I confess, freely, that you puzzle me just as much as at first. I can see no earthly reason for your saying that you can help me, can make me whole, if it is beyond your power to do so. I do not believe that it is. I think that you are sincere, *perfectly* sincere, and that you can make me whole. Yet you do not. Every time you hypnotize me, greater blanks<sup>1</sup> are produced in my memory. I am put to all sorts of shifts and pretences to save myself from open sneers and ridicule. Can’t you see how very hard it makes things for one? And won’t you, if you can, tell me wherein I am lacking? What must I do? How co-operate with you to gain the good you prophesy? I cannot, I will not, endure this existence another year.

“Do not misinterpret what I have written, Dr. Prince, and believe me,

“Sincerely and penitently,”

[Oct. 8, 1900. Forged letter (by Sally) from me to B I.]

“MY DEAR MISS BEAUCHAMP: When you have learned self-control and can behave like a rational being I shall be glad to do what I can for you. At present all my effort is worse than wasted because of your attitude of hostility. I do not wish to spend valuable time in this manner.”

<sup>1</sup> The “blanks” referred to were either B I or the new (completely fused) self.

[From IV.] “Sally has said so much of your disliking to receive letters that I hardly dare venture to write you. Yet there are certain things which must be explained, if possible. I did not intend yesterday to express the slightest doubt regarding Dr. P——t’s ability. It was only that I felt, and still feel, the utter hopelessness of attempting to treat the — trouble with pills and powders. I know that I have brought it all on myself, and that you consider me greatly to blame for the complications of the past year. But I did not understand until a few weeks ago what these complications might lead to, and how very serious the matter really was. . . . How can I explain such things to Dr. P——t, to any one? Dr. H—— should never have known had I not believed, in my pride, that I could end it all immediately. I am wiser now. I bow to Sally unless you help me, and, as B IV, I cannot hope for that. . . .”

[P. S. by Sally.]

“DEAR DR. PRINCE: Please let me know, or let B IV know, what day you want to see her. And *please, please*, don’t scold me because of what she says. I was so glad to see you last week, and so was she. She cried when Dr. P——t said, take the chocolate tablets. Don’t tell her anything I say, will you?  
“S. B.”

[From Sally, October 9, 1900.] “You didn’t give me the bills as you said you would, so that unless I write you this afternoon, or write the family, I shall certainly get into mischief again. I can’t help it. I haven’t been here since I brought B I yesterday, and I’m simply aching to do something. I’d like to go way off ever so far in the country, or else be in a spilly boat, — one of the sea-sick kind, you know — for hours and hours. It would be so splendid!

“I don’t know who is here now. These new people, or new-old ones, whatever they are, are most puzzling. I thought B II was always B II whether you hypnotized B I or IV, but she isn’t. If you start with B I, II is more like her, and if you start with B IV she’s more like that. Don’t you think so?<sup>1</sup> And then after she wakes up again it’s the same way.

<sup>1</sup> So far as II is concerned Sally is mistaken, but after waking, all sorts of mixtures could be made.

I don't think they're properly mixed, for you don't get a new one, as you thought you would. It's only B I with IV's memories or IV with B I's memories. It is, really. Can't you see it? I should think you could, from their letters and manner.

"That old journal they're so proud of is the funniest thing — it does n't go so ———, as it should, but so ——— / ———  
And sometimes it's backwards, and sometimes it's wrong, — upside down, you know. I could improve it immensely and make it heaps more interesting if I were to revise it. Would you? It would be great fun.

"I did n't want her (It, B I, or IV) to write you that letter last night, but she was determined to do it.

"I think that when you try to put them together that afterward if it's B I in the beginning she's stronger, and if it's IV in the beginning she's weaker. Ordinarily I could have made B I dead and confiscated the old letter; or I could have written IV and she would have destroyed it herself. You spoiled *all* that, you see, so, 'you must take the consequences;' as you say to me always.

"We are friends again, aren't we, Dr. Prince, for I brought B I back to you? I'm going to be perfectly angelic now, but you must suggest things [to do].

"SALLY."

November 30, 1900, one of the new selves had written an analysis of her mental attitude as IV with fused memories. The latter part of this was made illegible by Sally, who enclosed the following:

*"I won't have any more psychological papers in this family! So!*

*"You could keep me if you wanted to! You want me all squeezed again!"*

The following incoherent letter illustrates the rattling of B I's mind as a result of her many trials. It is one of many such:

*"If you can come to me morning that you will, so to trouble you.*

*"Sincerely,"*



## APPENDIX O

ON another occasion B IV had a vision which in its genesis resembled the one just described, and is worth mentioning as evidence of the origin of visions. B IV was in one of her nervous, fatigued states, as a result of a battle with Sally, and was much wrought up over the possible fate of some bogus letters which Sally had written to me. The letters were not intended for my eyes, but for IV's perusal. In each letter she described every little private act of IV and thought of I, such as no one would want any one else to know of one's self, and then left the letter where IV might see it. IV's consternation and fury at finding her life laid bare may be imagined. Of course she destroyed every letter she could lay her hands on, but some Sally managed to save, and made her believe that they, along with others, were sent to me, though Sally never had any intention that I should see them.

On learning that I had not received the letters, IV's anxiety was increased by the fear that they had fallen into less friendly hands. In this condition of mind she set out for Cambridge, thinking that she might have sent them by mistake in a state of abstraction to a friend who lived there.

Now I had very earnestly forbidden visits to Cambridge, and her *conscience told her* that she should not go. However, she went, and when she reached Harvard Square, a moment after stepping off the car, she saw me standing before her and heard me upbraid her, saying, "Don't you think you owe me something in return for what has been done for you?" These were the same words I once used in reprimanding her.

## APPENDIX P

THE first of the following wrathful letters from Sally was owing to my having remarked to the Real Miss Beauchamp that after all Sally was only a part of herself, and was a child not to be taken too seriously. It was written during one of the break-downs.

“I’m *not* a child. If you think I am, you’re *terribly* mistaken. That comes of having a lot of theories that you fit people to, regardless of what those people really are. It’s *always* your theories you have in mind — not at all the people. You could n’t make me a part of C. if you tried for fifty years, and she can’t do it either. Just because she’s ashamed of certain tastes she has — tastes which are really her salvation — she fancies that ‘Sally is cropping out again.’ Why don’t you read her journal? Why don’t you see what’s wrong with her, instead of blaming me for everything? Am I the only person who likes to be amused? the only one who finds men interesting? How perfectly silly to blame me for what she does! And what rot to argue that, because she is now doing some of the things I always liked to do, that we are identical. I am *myself* — just as different from C. as you are. And you’ve been wicked, hard, and unkind to me. You’ve *tried* to make me dead. You wanted me just as long as you thought there were things to be discovered about C., and then, when you fancied you knew it all, you squeezed me almost to death. My not being wholly dead simply shows that you don’t know *quite* everything yet — even about C. How *could* you do it? Do you *like* to treat me so? You ought to have let me alone — left me with people who do understand. Weren’t you truly sorry for my being shut inside years and years and years? Do you remember all you said to me about it, or have you forgotten, as you forgot the hickory, dickory, dock and Mother Hubbard things?<sup>1</sup> I’m going away soon. Shall you miss me? But I could n’t believe what you say. You’ve treated me like

<sup>1</sup> Referring to a test of Sally’s persistence under ether.

hell. If one of those hypnotism men put C. to sleep I could stay as long as I wanted to. That's what I'm going to do."

[Another letter.] "If you think that person<sup>1</sup> is C., then you don't know very much about psychology. Don't you know C.? I am not jealous, but I'm not squeezed either. That was mock ether. I know C. and I know the difference between real people and the kind you make up. C. is real. This one is made up. You forget the willing part. You are n't fair to me, and when you tell that person you are, it is only to hoodoo. I would n't be jealous of her. Pooh!

"SALLY BEAUCHAMP."

The following is a hallucinatory forged letter from Sally to one of the Miss Beauchamps and copied as a hallucination from a blank sheet of paper by "Miss Beauchamp."

"Because of your apparently broken condition last night I did not wish to dwell upon the 'hallucinations.' But please understand that they are likely to be repeated. Pull yourself together and take them as they come. If you particularly dislike them you can always 'move on.'

"Sincerely,

"M. P."

"I shall not be able to see you to-night."

## APPENDIX Q

THE following illustrates Sally's inability to write when badly "squeezed." She was then obliged to resort to printing; sometimes both printed and written characters were illegible. Ordinarily, her handwriting is like that of the primary personalities, and very different from that given below.

<sup>1</sup> An incompletely fused person with combined memories, but not C. in character.

DONT TALK FRENCH  
TO [C.] I DONT  
LIKE IT I WA  
NT YOU TOT  
TALK TO ME  
I WANT to stay  
always you  
did say you  
liked me

[1]

but and you  
did say you  
wanted me to  
stay last year  
you said I  
and it was  
true for you

[2]

arent for  
away

~~from~~ all the time  
to make me  
~~rejoiced~~  
you are now  
with C. and  
to be used to the  
information

IF I HAD TOLD YOU  
EVERYTHING ABOUT  
[C]. AND ID YOU  
COULDN'T HAVE CUR  
ED HER OR WRITTE  
ANYBOOK OR PAPER  
we done all together  
you & you and me

## APPENDIX R

THIS surmise proved afterwards to be correct. Shortly after this volume went to press, to clear up this point B II was examined again, and B III was also examined both as to the trance and as to the presence of co-conscious ideas following the trance. The following was elicited: B II recalls the scene following the crisis; the whole arises before her almost as vividly as a vision. She remembers innumerable pictures that passed as in a panorama subconsciously through her mind.<sup>1</sup> The pictures were fanciful and apparently without relation to one another,— pictures of nature (sunsets), and of persons, and religious pictures. For instance, a picture of “Christ walking by the olive trees,” and one of “the Virgin with the child in her arms; the Virgin is just about to go away, and she turns back and looks at me. It was dear!” B II visualizes her memory in a marked way, describing vividly the situations, and using her hands to point out the different relations of the actors and the surroundings, as if the scene were still before her. She describes exactly how the Virgin stands; “the expression of her face is most beautiful; she has brown eyes, and there is more color in her face than is usually painted in pictures.” (B II does not remember any painting resembling this visualized memory.) None of these subconscious pictures that she now recalls were identical with the memories (pictures) of the trance state, though similar in kind. (The patient volunteers the remark that at the time of the first examination she recalled these subconscious pictures.)

B II now describes the emotions which accompanied these various kinds of subconscious pictures. They were

<sup>1</sup> That is, she remembers now that they were present, although at the time she was not conscious of them.

all "exalting, uplifting, and satisfying," and she, as Miss B., at the time, *consciously* felt them. (As B II recalled the religious subconscious pictures, she experienced over again the same emotions in a minor degree.) B II cannot say, however, that these emotions came from the subconscious pictures, as they were consciously "present there, anyway," as a residue of the trance state, and continued although the subconscious pictures changed from moment to moment.

The examination of the third state, B III, was made by means of automatic writing which was performed during the hypnotic state, B II. The memory of B III for the trance in the church is, at the present time, at least, more complete than that even of B II. The same I have found to be generally the case, particularly in connection with subconscious, trance, delirious, dream, and allied phenomena. It is, therefore, likely that B III describes a momentary condition of which B II has never had a memory, as she has not to-day. The mental content of this trance moment was not important, being made up of a dreamlike conscious state, accompanied by emotions of joyousness. B II cannot recall this dream to-day, although she can revive, as has just been said, all the other memories with great vividness. Whether or not any of the ideas (memories, visions, etc.) of the trance state persisted subconsciously *as such*, after coming out of the crisis, is not clear. The evidence of the automatic writing was to the effect that this was in a fragmentary way the case, but the specific instances given could not be identified for various reasons. Nevertheless the memory of B III corroborates that of B II to the effect that numerous subconscious ideas were present after the crisis, as already described.

One point of interest and of practical importance in this observation is the difference in the completeness of the

memories of the several hypnotic states, B Ia, B II, B III. This conforms with what is known of memory synthesis in hypnosis, and emphasizes the fallacies which may follow from relying upon any given group of memories, whether of the waking or other states.

In the further discussion of the phenomenon of sudden conversion I have pointed out (p. 355) that the analysis of a large number of cases *made at the time of the crisis* is essential if we would discover the exact psychological conditions involved in the problem. I am now enabled to add another case which I had an opportunity to subject to psycho-analysis almost immediately after the crisis. Although it is not of the religious type, it is the same in principle, being a conversion from the attitude of mind of doubts, dissatisfaction, bitterness, and rebellion against life to one of peace, contentment, and faith. The fact that the same phenomena are observed where the conversion is not of religious faith is of importance in connection with the spiritualistic interpretation; for manifestly if we find the same phenomena where religion is not a factor, but where the psychological conditions are identical, the phenomena may be referred to a common principle, viz., psychological laws.

The subject was one particularly favorable both for the development of the phenomena in question and for a psycho-analytical investigation. She is a cultivated, intellectual person, who is interested in psychological problems and contributes her co-operation to their solution. She can be easily hypnotized and several states obtained, each with a different range of memory. The time of the episode was the anniversary of her husband's death, which had happened three years previously, and in consequence of which she had gone through much mental anguish, more than ordinarily belongs to such sorrow, owing to certain indirect consequences which the necessity of concealing the identity



of the subject forbids my referring to. This fact, however, has a direct bearing on the phenomenon. As the anniversary approached, the painful memories began to occupy her mind, and during the two preceding weeks she was tormented by doubts, pain, and distress. Harassing dreams, not remembered, however, after waking, had produced physical pain in the form of headache and prostration. These had been recovered from before the episode occurred. When the day was near, she determined to fight against the distressing memories and the old ideas of dissatisfaction with life, the feelings of injury, bitterness, and rebellion against fate, and the "kicking against the pricks" which these memories evoked. For a long time she had tried to accept the new situation and the new ethical point of view, but with only temporary success. With great effort she heroically put all these ideas out of her mind and did not allow herself to think of them. She supposed she had done so successfully.

My first intimation of what occurred was contained in the following letter, which, it should be noted, was written an hour after the occurrence, while the facts were vivid in her mind:

"It is one o'clock in the morning, but I feel I must write you of the strange thing which has just happened to me. To-day, or rather yesterday, was the day of my husband's death. I kept myself very busy all day and would not allow myself to think, but when I came to my room at night I could no longer repress the memories against which I have steeled myself for more than a week. It came upon me like a flood — all that I had lost — all that I could never have again — memories of happy days and bitter ones. I did grieve, I did feel all the old remorse, the old self-reproach, the bitter rebellion and anguish of heart. I could not help it, Dr. Prince — there was no one to speak to and I had fought against it as long as I could. Mr. — died just before midnight, and as that hour approached I was kneeling by my bed — not to pray — my heart was too bitter for that — I don't know why I was kneeling — but all at once I saw my husband before me, perfectly plain and distinct but not ill and

worn as I remember him. He looked well, strong, happy. He stood on the other side of the bed from me and seemed surrounded by a luminous vapor, and his whole appearance was of brightness. As I looked he spoke — the words ring in my ears now. He said : ‘ If I were still ruled by earthly emotion nothing could make me so unhappy as to see you as you are now. As when I was with you I wished you to be happy so I wish you to be happy now. Remember me or forget me — it makes no difference in the end — love never dies. Think no more sad or gloomy thoughts, fill your life with every pleasure ; by so doing you make possible to me a higher, fuller life.’

“ A feeling of peace, so deep, so enthralling, came upon me. I felt his love about me like an atmosphere — it was almost palpable — I rested in it. I did not move, and the vision faded. I was not asleep, Dr. Prince. I did not lose consciousness. I am somewhat unnerved now. I hardly know what to think. Several explanations suggest themselves to me at once. I had eaten very little — I was somewhat exhausted by several hours of grief. The words represent thoughts I have sometimes had myself ; they may also be suggestions you have given me in hypnosis, they may be something I have read — I don’t know ; but it has made a deep impression on me, and though I am no believer in spiritism I cannot help but feel that at least with him ‘ all is well.’ The past is gone, the present is mine, and I will, with your help, try to use it wisely. This is Tuesday morning, 1.15, — 1908.”

Here was a chance, not to be lost, to investigate the psychological conditions underlying the hallucinations and the after effects. So, at the first opportunity, a few days later, a psycho-analysis was undertaken. The conditions to be determined were : First, the conscious content of the subject’s mind preceding the hallucinations ; second, the character of the mental state at the time of their occurrence ; third, what, if any, co-conscious states existed previous to, during, and after the hallucinations ; fourth, the character of the mental complexes succeeding the episode. Taking the last first, it is sufficient to say that the subject was in an unusually happy and peaceful state of mind, in kind that described in the last sentence but one of the letter. She was not, however, in a state of ecstasy or undue

elation, but rather in a normal, peaceful mood such as one would attain who had lost previously distressing doubts, memories, and perverted points of view and now had attained a new and more healthy conception of life and her relation to it. The emotional tone was that of joyousness and happiness, which stood in marked contrast with the mental tone which, for the most part, as I have observed it, has dominated her conscious life. Physically and mentally she seemed unusually well. She could not give any further explanation of the development of the hallucinations beyond what she had written. She remembered nothing more that threw light upon the incident. It proved afterwards, however, that there was a gap in her memory.

The psycho-analysis was made in three different hypnotic states, the memories of which, as with Miss Beauchamp, were not coextensive. The general result may be thus summarized: While the subject was on her knees, her glance fell upon a photograph of her husband. From the glass covering this a bright electric light was reflected directly into her eyes. She went into a light hypnotic condition in which she had the hallucination. After coming out of this light trance there was no amnesia for it excepting for the perception of the photograph which she did not consciously recognize, but the visual hallucination came at the moment when her eyes met the photograph.

The conditions were more complex, however, than this. During the two weeks preceding the crisis, as a result of the stress and strain through which she was passing, there developed a condition of light disintegration. The thoughts which she believed she had put out of her mind continued to a greater or less degree as a stream of subconscious thought. She was not aware of this stream, although from time to time it arose into her consciousness only to be put out again. Besides this there were all sorts of co-conscious memories of the past in the form of visual pictures, similar

to what has been described in the Beauchamp case. Just before she had the hallucination there was present a co-conscious visual picture of her husband. This undoubtedly co-operated with the co-conscious perception of the photograph to produce the visual hallucination. The words spoken by the voice were a reproduction in substance of words spoken to her about two months previously by a friend who tried to reconcile her with the conditions of her life. This she had forgotten in the sense that she had not recalled it or connected it with the episode. The experience was voluntarily recalled by only one of the dissociated states which offered it as explanation of the hallucinatory words. The other two and the subject herself recognized the identity of the sentiments and probable origin when asked if this friend had ever spoken of the matter to her. The hallucinatory words were, therefore, a conscious automatism arising from the *unconscious*.

Succeeding the crisis there also developed co-conscious pictures which affected her consciously and tended to strengthen the new faith in the conditions as they existed, and the new attitude of mind.

This case, then, lends further support to the interpretation, discussed in the text, of the psychological conditions of sudden conversion in a certain type of cases.

## INDEX

- Aboulia**, 118, 120.  
 definition of, 15.  
 due to subconscious ideas, 120.  
 examples of, 121, 123, 124, 469.
- Absentmindedness**, 192, 193.  
 a form of dissociation, 193.  
 not identical with hysterical anesthesia, 193.
- Abstracting**, as a method of studying systematized anesthesia, 69.  
 and automatic speech, 501.  
 and automatic writing, 61.
- Akinesia** Algeria, 94.
- Alexia**, induced by subconscious action, 508.
- Alternation**, of rational hypnotic self with ecstatic waking self, 348; of sane and delirious personalities, 114-16, 226, 475.
- Amnesia**, anterograde, 236.  
 hysterical, 74-5; due to dissociation, 255-61, 263-4.  
 not essential for alteration of personality, 236.  
 of B IV and B I, of hysterical type, 255.  
 of B IV and B I for "new person," 402; for the Real Miss Beauchamp, 522.  
 retrograde, 217, 236, 258.  
 subconscious induction of, 285.
- Anesthesia**, hysterical, 76-8; due to dissociation of consciousness, 76, 78; experiments in, 77.  
 peculiar form of, manifested by Sally, 147.  
 systematized, 67-76, 78, 189-94; dissociated images remain isolated, 192; dissociated images part of a subconscious self, 194; due to belief, 191; due to dissociation of consciousness, 456; due to subconscious willing, 194; experiments in, 67; subconscious induction of, 284, 538, 539-40.
- Angst-Neurose**, 132.
- Automatic**, facial expression, 157-8.  
 inhibition of thought, 275.  
 speech, 58-60, 157, 275, 431, 469, 501, 507, 532.  
 writing, 61, 62, 361-6, 376-7, 379-80, 382-6; as manifestation of alternation of consciousness, 147, 365-6; as evidence of a co-consciousness, 365.
- Automatisms**, 58, 177.  
 as evidence of co-consciousness, 145, 158.  
 emotional, 262.  
 motor; examples of, 37, 58-60, 93, 94, 156-7, 158, 162, 256, 257, 284, 501 *note*, 538.  
 sensory (see *Visions*), visions regarded as, 85.
- Auto-suggestion**, influence of on hypnotic states, 447.
- Azam**, 5.
- B I**, amnesia for new person, 402; for Real Miss Beauchamp, 522.  
 character-traits of, 288-94.  
 insistent ideas, 295-7.  
 somnambulistic theory of, 213, 234, 236.  
 stigmata of hysteria, 237.
- B II**, a synthesis of B I and B IV, 267-72, 282, 449; the Real Miss Beauchamp, 519.
- B IV**, amnesia for new person, 402; for Real Miss Beauchamp, 522.  
 character-traits of, 288-94.  
 dissociation and automatism, 283-5.  
 insistent ideas, 295-7.  
 sources of knowledge of amnesic periods, 243, 253.  
 theory of being Real Miss Beauchamp, 215-17, 238.
- B IV a**, character of, 446-7, 452-4; as a type of disintegration, 445.
- Bain**, *quoted*, 326.
- Barrow**, Ira, 194, 331.
- Bernheim**, 68.
- Binet**, *quoted*, 69, 70; 232.

- Blindness**, hysterical, 69, 191, 286; monocular, 148.  
subconscious induction of, 284, 538.
- Boeteau, M.**, 459 *note*, *quoted* 470.
- Cases cited:**  
A. B., 133.  
Anna Winsor, Miss ("Old Stump"), 194, 331.  
Ansel Bourne, 186, 213, 236.  
B., Mme., 4, 46 *note*, 146 *note*, 366.  
B—w, S., 75.  
C. D., Mrs., 133.  
Charles W., 234, 236.  
D., Mme., 257.  
E. B., Mrs., 77, 78.  
Fanny S., 62, 74, 75, 353, 354.  
Félida X., 5, 232, 233 *note*.  
H., Mrs., 62.  
J—n, Mrs., 235, 286.  
Louis Vivé, 5.  
Lucie, 460.  
M—l, 152, 256, 465, 510.  
Marcelline R., 233 *note*.  
Marie M., 470.  
Mary H., 353.  
Mary Reynolds, 233 *note*.  
R., Mrs. ("Mamie"), 4, 43 *note*, 78.  
Ratisbonne, 350, 551.  
"Smead," Mrs., 4.  
"Smith," Miss, 4.  
Thomas C. Hanna, Rev., 213, 260.  
W., Mrs., 263.  
Wilson's case of multiple personality, 474 *note*.
- Character**, alterations of, not wholly due to memory, 299, 300, 410–11.  
artificial modifications of, 403–5.  
differences of, in B I and B IV, 201.  
traits of B I and B IV, 288–96.
- Charcot**, 148, 257; *quoted*, 533.
- Chris** (see Sally).
- Co-consciousness and Concomitant consciousness** (see **Subconsciousness**).
- Consciousness**, alternation of a sane and delirious, 114–16, 226, 475.  
coexistence of a sane and delirious, 83, 116, 226, 257, 458, 471, 475.  
latent, 530.  
normal secondary, 86.  
persistence of secondary, during sleep, 329–31, 333–41.  
content of, in trance state, 348–9.
- Conversion**, disintegration in sudden, 353–4; part played by the subconscious in sudden, 352–3.
- Deafness**, from subconscious influence, 457.
- Delirium**, coexistence of a delirious and a sane consciousness, 83, 116, 226, 257, 458, 471, 475.  
hysterical, 114, 194.
- Disintegration** (see **Dissociation**), 75.  
of personality, examples of, B a, 472; B I a, 307; B I b, 462; B II a, 462; B IV a, 445; B IV b, 256, 457–9, 461; B IV c, 462–65; B IV d, 466, 472; B V, 267, 466.  
as factor in hallucinations, 354, 512–3.  
other examples of, 256–7, 506, 537.  
schemata of, 308, 309, 448, 465, 466, 520.  
the expression of neurasthenia, 523.
- Dissociated ideas** (see **Subconscious ideas**), 69.  
memories recovered in abstraction, 254–5.  
sensations (see **Systematized Anesthesia**).
- Dissociation of consciousness** (Personality) (see **Disintegration and Systematized Anesthesia**), 3, 22, 75.  
a normal process, 193.  
as a factor in sudden conversion, 354.  
as basis of hypnotic states, 461, 474.  
in amnesia, 255–61, 263–4.  
in hysterical anesthesia, 76, 78.  
in sleep, hypnosis, and absent-mindedness, 75, 193.  
in systematized anesthesia, 69–70, 456.  
in trance and epileptoid states, 193.
- Donley, John E.**, 262 *note*.
- Doubling of consciousness** (see **Automatism, Subconsciousness, Systematized Anesthesia, etc.**).  
as an artifact, 50.  
difficulty of proving in normal persons, 42, 50.  
evidenced by coexistence of sane and delirious consciousness, 83, 116, 226, 257, 471, 475.  
in absentmindedness, 192.  
in hysteria, 45.  
in systematized anesthesia, 69.  
result of dissociation, 22.
- Doubling of perceptions**, 83.

- Dreams**, part played by secondary consciousness in, 328-9; time of occurrence and persistence of, 331-2.
- Dumbness**, as result of subconscious influence, 275, 284, 285, 540.
- Ecstasy**, 345.
- Emotion**, as factor in sudden conversion, 348-54.  
 difference in psychology of, and ideas, 325.  
 disintegrating effect of, 20, 22, 65, 215, 324, 354, 458-61.  
 integrating effect of pleasurable, 324-5.  
 revived by association, 87, 262.
- Emotional automatism**, 262-3.
- Emotions**, common to B I and B IV, 297-8, 324; induced by subconscious ideas, 297-8, 324.
- Epileptoid states**, forms of dissociation, 193.
- Fear** (see **Obsessions**), indefinable, from subconscious ideas, 132-5, 297-8, 324.
- Féré**, 68, 69.
- Fixed ideas** (see **Imperative ideas**), examples of, 133.  
 in hysterics, 295-7.  
 subconscious fixed fear, 132.  
 subconscious, in hysteria, 45, 61, 132-5, 297-8.
- Flournoy**, 4.
- Greenwood**, 449 *note*.
- Griessinger**, 286.
- Gurney**, Edmund, 43, 474.
- Hallucinations** (see **Visions**), absent in normal self, 524.  
 as expressions of belief, 176, 189, 216, 285, 286, 321-2, 354, 417, 440, 506, 509, 511-12, 540.  
 from subconscious ideas, 509-10, 548-50, 559.  
 induced by subconscious volition or action, 284, 416, 432, 483-4, 486, 497, 507-9, 536, 539-40, 561.  
 negative (see **Systematized Anesthesia**), 68, 189-94; due to belief, 191; due to subconscious willing, 194.  
 sensory, induced by subconscious suggestion, 451-2.  
 subconscious induction of, 285, 286, 539, 548-50.
- Health of different personalities**, 17, 287.
- Hodgson, R.**, 5, 186, 197, 235, 239, 244.
- Hypnosis**, a form of dissociation, 193, 461, 474.
- Hypnotic self**, B II a synthesis of two personalities (B I and B IV), 267-72, 282.  
 may refuse suggestions, 449-51.  
 memory of, 85.  
 memory for subconscious states, 44, 46, 48, 73-5.  
 not equivalent to subconscious self, 42-5, 74.
- Hypnotic states**, number in same person, 474.
- Hyslop, J. H.**, 4.
- Hysteria**, dissociation of mind in, 22.
- Illusions**, as expression of a belief, (see **Hallucinations**) 216, 285.
- Imperative (insistent) ideas** (see **Fixed ideas**), of subconscious origin, 61, 121.  
 in hysterics, 295.
- Impulsions** (see **Motor Automatism**), 61, 104, 118, 120.  
 due to subconscious ideas, 120.  
 examples of, 121, 124.
- Instability**, hysterical, 65.
- James, William**, 5, 186, 350-2, 551.
- Janet, Jules**, 233.
- Janet, Pierre**, 69, 70, 121, 146 *note*, 193, 257, *quoted*, 295; 299 *note*, 366, 460.
- Laségue's Symptom**, 149.
- Linenthal, H.**, 152.
- Mayer, Edward E.**, 234.
- Memory**, isolated flashes of, 253, 261.  
 recovered through process of abstraction, 254; through visions, 255.
- Memories**, of B I and B IV fused by suggestion, 400-4.
- Mental Strain**, 466.
- Meyers, F. W. H.**, 460 *note*.
- Mitchell, S. Weir**, 233 *note*.
- Neurasthenia**, disappearance of, in complete synthesis of the "new person," 404, and of Real Miss Beauchamp, 523-4.

- Neurasthenia** — *continued*.  
 hysterical, examples of, 65.  
 expression of disintegration, 523.  
 result of disintegration, 22, 287, 459.  
 result of emotion, 459.
- Neurosis**, association, 22, 262.  
 traumatic, 22, 23, 64, 459.
- New B I and New B IV**, incomplete synthesis of I and IV, 401-3.
- New Person, The**, a complete synthesis of B I and B IV, 401-3; absence of neurasthenia in, 404.
- Obsessions** (see **Impulsions and Fixed ideas**), 132.  
 of subconscious origin, 61.  
 indefinable fears, 132-5, 297-8, 324.
- Parinaud**, 148.
- Perception**, doubling of, 83.  
 personal in systematized anesthesia, 73, 192; failure of, in same, 69.
- Personality**, alternation of, 3; amnesia not essential for same, 236; amnesia of disintegrated, due to dissociation, 263.  
 disintegrated, 3, 474-5; etiology of same, 22.  
 frequency of changes of, in case of Miss Beauchamp, 205, 334-41, 530, 541-7, 552.  
 multiple, 3, 4, 5, 474-5.
- Personalities**, secondary, pathology of, 475; often mistaken for normal self, 233; not normal and always inferior to original self, 233.
- Pitres**, 148.
- Real Miss Beauchamp**, 402, 406, 516-21.  
 freedom from abnormal phenomena and ill health, 404, 524.
- Sally** (Chris), anesthesia, 147.  
 as a sane subconsciousness during delirium, 83, 116, 145, 226, 458, 471, 475.  
 as a subconsciousness, 17, 45, 50, 53, 145.  
 as an alleged continuous co-consciousness, 393, 439-43.  
 claims never to sleep, 153, 326, 330, 333-41.  
 disappears in complete synthesis of B I and B IV, 405, 524.  
 extent of subconscious field, 154.  
 freedom from ill health, 149, 162, 287.  
 her explanation of dreams, 328-30.  
 hypnotizes B IV, 319.  
 ignorance of B IV's thoughts, 181.  
 ignorance of time, 153-4.  
 memory, 81, 151, 238, 501.  
 never dreams, 376 *note*.  
 question of subconscious existence, 145.  
 remembers forgotten dreams, 153.  
 without sense of fatigue, 150, 287.
- Sedgwick, Mrs.**, 474.
- Self** (see **Personality**), normal real, 232.  
 normal real, often mistaken for secondary self, 233.  
 that best adapted to any environment, 233.
- Sidis, Boris**, 152, 213, 256, 260, 265 *note*, 352 *note*.
- Sidis and Goodhart**, 260.
- Sleep**, a form of dissociation, 193; persistence of secondary consciousness during, 329-31, 333-41.
- Souques**, 257.
- Subconscious ideas**, 44, 45. (See **Dissociated ideas**.)  
 induction of alexia, 508; of amnesia, 285; of automatic speech, 256-7, 284, 416-7, 431, 457, 469, 501, 507; of blindness, 284, 538; of deafness, 457; of hallucinations, 284, 285, 286, 321-2, 417, 432, 451-2, 483-4, 486, 497, 507-9, 536, 539, 548-50, 561; of hypnosis, 319; of muscular movements, 156-7, 256-7, 284, 538; of systematized anesthesia, 284, 286, 538.  
 inhibition of hearing, 322; of speech, 275, 284, 285, 537, 540; of thought, 275.  
 mind as factor in sudden conversion, 352, 353.  
 perceptions, 54, 279, 328-9; in systematized anesthesia, 70.  
 reasoning, 37, 189, 365, 442.  
 spontaneous action on primary mind (see **Aboulia**, **Automatism**, **Automatic speech**, **Writing**, **Deafness**, **Dumbness**, **Hallucinations**, **Visions**, etc.), 283-5, 438-42.  
 suggestion to primary self, 438, 456.



- Subconscious self**, definition of, 18, 46.  
facial expression of, 157-8.  
not equivalent to hypnotic self, 45.  
required to be hypnotized coincidentally with the primary self, 322-3, 450-1.  
Sally (Chris) as a, 17, 45, 50, 53, 145, 438-43.
- Subconsciousness**, definition of, 46, 529.  
difficulty of proof of normal, 42.  
Sally's account of her own thoughts, 438-42; interpretation of same, 442-3.
- Suggestibility**, 66.
- Suggestion**, post-hypnotic, 36, 43, 60, 69, 109; (phenomena) as artifacts, 43, 50, 57, 74; as manifestations of doubling of consciousness, 50, 57; as systematized anesthesia, 69.  
subconscious, to primary self, 438, 456.  
therapeutic effect of, 20, 21, 139, 143.
- Thompson, Mrs.**, 474.
- Trance**, as factor in sudden conversion, 348-50.  
a form of dissociation, 193.  
induced by associated ideas, 87.  
states, 87-9, 348.
- Vision**, of B IV's advent, 211.  
of Christ, 548.  
of hospital episode, 220, 531.
- Visions**, crystal, 78, 159, 284, 536.  
experimental study of, 55.  
produced by fixation of attention, 210, 211, 255.  
series of experiments in crystal, 55, 79.
- Willing**, subconscious, 58, 93, 94.
- Wills**, contest of, 120, 122, 125, 157, 285, 540.
- Wilson, Albert**, 474.
- Zwangsvorstellungen**, 121.

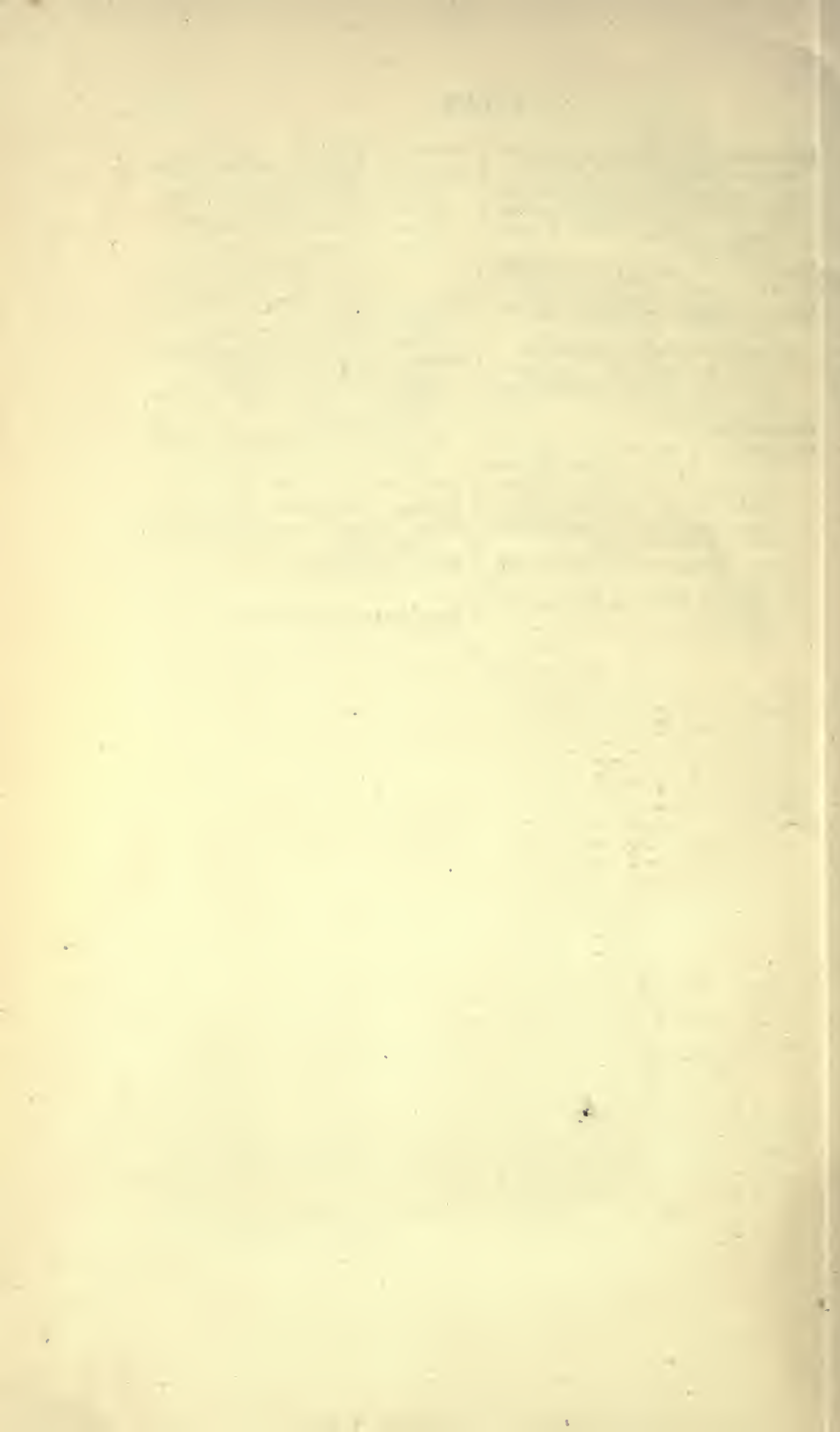









*[Faint, illegible handwritten text]*

*[Faint, illegible handwritten text]*

117494

Prince, Morton  
Dissociation of personality.

"A"

MN  
P

DATE

University of Toronto  
Library

A

DO NOT  
REMOVE  
THE  
CARD  
FROM  
THIS  
POCKET

Acme Library Card Pocket  
LOWE-MARTIN CO. LIMITED

